

## CONTENTS

<b>HMI AND PLC CONNECTING GUIDE</b> .....	<b>- 1 -</b>
1 SERIAL COMMUNICATION PIN DEFINITION .....	- 1 -
2 PRINTER CONNECTING CABLE DIAGRAM .....	- 3 -
2.1 Serial Interface Printer Cable .....	- 3 -
2.2 Recommend Optional printer .....	- 5 -
3 DOWNLOAD CABLE DIAGRAM.....	- 7 -
3.1 Download by Serial Port .....	- 7 -
3.2 Download by USB .....	- 7 -
3.3 Download by Network Ethernet.....	- 7 -
4 COMMUNICATION SETTINGS AND GUIDE OF HMI CONNECTING WITH CONTROLLER.....	- 9 -
4.1 ABB Corporation.....	- 9 -
4.2 Allen-Bradley .....	- 13 -
4.3 ACS-Tech80 Motion Controller .....	- 46 -
4.4 ADAM.....	- 47 -
4.5 AysjNet .....	- 50 -
4.6 BACnet.....	- 51 -
4.7 Baldor NextMove ES (Motion Controller).....	- 57 -
4.8 Barcode .....	- 59 -
4.9 Baumuller.....	- 60 -
4.10 Beckhoff.....	- 61 -
4.11 Bosch Rexroth KVFC+ (Inverter) .....	- 78 -
4.12 Bosch Rexroth.....	- 79 -
4.13 Bosch Rexroth Ethernet.....	- 88 -
4.14 CANOpen Node Slave .....	- 94 -
4.15 Cimon .....	- 99 -
4.16 Danfoss Inverter .....	- 101 -
4.17 DCCE .....	- 107 -
4.18 Delta Corporation.....	- 110 -
4.19 Delta (Temperature Controller) .....	- 117 -
4.20 DL_T645 2007 Standard (Electric power meter) .....	- 124 -
4.21 ENDA.....	- 128 -
4.22 Emerson NetWork Power .....	- 129 -
4.23 Epower .....	- 134 -
4.24 Fatek Corporation.....	- 136 -
4.25 Fuji SPB .....	- 142 -
4.26 GE Fanuc Automation Inc.....	- 144 -
4.27 HAIWELL.....	- 154 -
4.28 HanG .....	- 155 -
4.29 Hitachi Inverter .....	- 156 -
4.30 Hitachi IES Co., Ltd.....	- 158 -
4.31 Hollysys Corporation .....	- 165 -

4.32 HuaDA HD-JZ06.....	- 168 -
4.33 IDEC Corporation .....	- 170 -
4.34 Inovance Electric Corporation.....	- 174 -
4.35 Invt .....	- 184 -
4.36 KDN Corporation.....	- 188 -
4.37 Kinco Corporation.....	- 189 -
4.38 Kinco Inverter .....	- 192 -
4.39 Kinco EB-MOD2P-01(Kinco Bus Bridge) .....	- 194 -
4.40 Kinco Servo Series .....	- 200 -
4.41 Kinco Master & Kinco Slave(Master/Slave Protocol Connection).....	- 203 -
4.42 Keyence Corporation.....	- 204 -
4.43 Koyo Corporation.....	- 212 -
4.44 KTC Srdlink .....	- 216 -
4.45 KYL Slave .....	- 218 -
4.46 LENZE Inverter.....	- 220 -
4.47 Liteon Corporation .....	- 222 -
4.48 LS Industrial Systems (LG) .....	- 224 -
4.49 LUST .....	- 252 -
4.50 Memory map .....	- 257 -
4.51 MEGMEET .....	- 258 -
4.52 Mikom .....	- 263 -
4.53 Millenium3 .....	- 265 -
4.54 Mitsubishi Electric Corporation .....	- 267 -
4.55 MKS controller.....	- 303 -
4.56 Modbus.....	- 304 -
4.57 MODROL.....	- 312 -
4.58 OE MAX .....	- 313 -
4.59 Omron Corporation .....	- 314 -
4.60 OMRON E5EZ-R3(Temperature Controller).....	- 337 -
4.61 OPTO 22 .....	- 339 -
4.62 Panasonic Electric Corporation .....	- 347 -
4.63 Parker Automation (Servo Controller) .....	- 357 -
4.64 PMAC Motion Controller .....	- 363 -
4.65 Power-one AURORA Wind Inverter .....	- 365 -
4.66 Profibus DP Slave.....	- 367 -
4.67 RF-IC (Card Reader).....	- 371 -
4.68 RKC Instrument INC.....	- 372 -
4.69 Saia-Burgess.....	- 374 -
4.70 Sailsors D9 (Temperature Controller) .....	- 376 -
4.71 Schneider Electric, Ltd. ....	- 377 -
4.72 SHIMADEN.....	- 393 -
4.73 SIEMENS.....	- 399 -
4.74 SIKO AG05 SIKONETZ5.....	- 433 -
4.75 Sinocon Sc1n.....	- 434 -

---

4.76 TAIAN.....	- 436 -
4.77 TCM.....	- 438 -
4.78 Toledo DLoadCell .....	- 443 -
4.79 Toshiba .....	- 444 -
4.80 Trio motion controller .....	- 447 -
4.81 Unitronics.....	- 455 -
4.82 Universal ASCII Slave .....	- 458 -
4.83 Vigor Corporation.....	- 460 -
4.84 XINJE Controller .....	- 463 -
4.85 XiLin Inverter.....	- 470 -
4.86 Yamatake Corporation.....	- 471 -
4.87 Yaskawa Electric Corporation .....	- 476 -
4.88 Yokogawa Electric Corporation .....	- 488 -
4.89 YuDian AI.....	- 494 -
4.90 ZiGuang Ethernet .....	- 499 -
4.91 ZHIMEI CB920X.....	- 502 -

## HMI and PLC connecting guide

### 1 Serial Communication Pin definition

- Serial port COM0

COM0 is a 9-pin D-Sub male port, this port supports RS-232C/RS-485/RS-422A communication, the pin definition as follows:

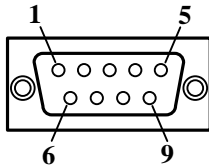

Pin	Signal	Function		
		RS-232C	RS-485	RS-422A
1	RX-(B)	--	RS485B	Receive data
2	RXD	Receive data	--	--
3	TXD	Transmit data	--	--
4	TX-	--	--	Transmit data
5	SG	Signal ground		
6	RX+(A)	--	RS485A	Receive data
7	NC	--	--	--
8	NC	--	--	--
9	TX+	--	--	Transmit data

- Serial port COM1

COM1 is a 9-pin D-Sub male port, this port supports RS-232C/RS-485/RS-422A communication, and the pin definition as follows:

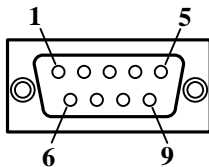

Pin	Signal	Function		
		RS-232C	RS-485	RS-422A
1	RX-(B)	--	RS485B	Receive data
2	RXD	Receive data	--	--
3	TXD	Transmit data	--	--
4	TX-	--	--	Transmit data
5	SG	Signal ground		
6	RX+(A)	--	RS485A	Receive data
7	NC	Clear transmit	--	--
8	NC	Request transmit	--	--
9	TX+	--	--	Transmit data

- Serial port COM2

The COM2 and COM0 use the same physical port, the 9-pin D-Sub male port. This COM port supports the RS232 communication only. The pin definition as follows:

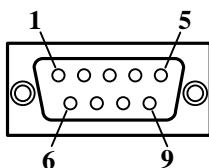

Pin	Signal	Function		
		RS-232C		
1	NC	--	--	--
2	NC	--	--	--
3	NC	--	--	--

4	NC	--
5	SG	Signal ground
6	NC	--
7	RXD	Receive data
8	TXD	Transmit data
9	NC	--

The COM2 can be used to download and upload HMI program, and connect to PLC via RS232 as well.COM2.

- Serial port COM3

The COM3 and COM1 use the same physical port, the 9-pin D-Sub male port. This COM port only supports the RS-485 communication . The pin definition as follows:

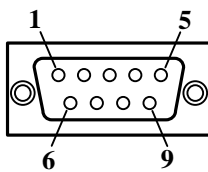

Pin	Signal	Function
		RS-232C
1	NC	--
2	NC	--
3	NC	--
4	NC	--
5	SG	Signal ground
6	NC	--
7	RX-(B)	485B
8	RX+(A)	485A
9	NC	--

## 2 Printer Connecting Cable Diagram

### 2.1 Serial Interface Printer Cable







#### 2.1.1 Brightek thermal printer



Users choose the protocol of thermal printer according to the dot-matrix of printer.

16 dots: WH-A62R10 protocol

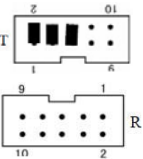
24 dots: WH-A93RG0-00E825 protocol

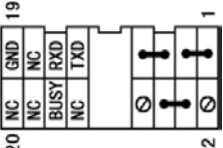
#### 2.1.2 Serial Interface Printer Cable of Brightek printer

Printer Type	Note								
<p><b>WH4008A31-053:</b></p> <div style="display: flex; justify-content: space-around; align-items: center;"> <div style="text-align: center;"> <p><b>HMI terminal 9pin D-SUB female</b></p>  <table border="1" style="margin: 10px auto;"> <tr> <td style="background-color: #ADD8E6;">com0/com1</td> <td style="background-color: #ADD8E6;">com2</td> </tr> <tr> <td>3 TX</td> <td>8 TX</td> </tr> <tr> <td>5 GND</td> <td>5 GND</td> </tr> </table> </div> <div style="text-align: center;"> <p><b>Bright Printer 26pin port</b> Note:the red line is the first pin</p> <table border="1" style="margin: 10px auto;"> <tr> <td>19 RXD</td> </tr> <tr> <td>24 GND</td> </tr> </table> </div> </div>	com0/com1	com2	3 TX	8 TX	5 GND	5 GND	19 RXD	24 GND	<p>pulling up W1 short circuit block by RS232 level</p> 
com0/com1	com2								
3 TX	8 TX								
5 GND	5 GND								
19 RXD									
24 GND									
<p><b>WH-A62R10、WH-E461RB01:</b> Support printing of 190 dots width.</p> <div style="display: flex; justify-content: space-around; align-items: center;"> <div style="text-align: center;"> <p><b>HMI terminal 9pin D-SUB female</b></p>  <table border="1" style="margin: 10px auto;"> <tr> <td style="background-color: #ADD8E6;">com0/com1</td> <td style="background-color: #ADD8E6;">com2</td> </tr> <tr> <td>3 TX</td> <td>8 TX</td> </tr> <tr> <td>5 GND</td> <td>5 GND</td> </tr> </table> </div> <div style="text-align: center;"> <p><b>Bright Printer 10 pin port</b> Note:the red line is the first pin</p> <table border="1" style="margin: 10px auto;"> <tr> <td>5 RXD</td> </tr> <tr> <td>9 GND</td> </tr> </table> </div> </div>	com0/com1	com2	3 TX	8 TX	5 GND	5 GND	5 RXD	9 GND	<p>Serial port printing mode via RS232 level, short circuit as follows:</p> 
com0/com1	com2								
3 TX	8 TX								
5 GND	5 GND								
5 RXD									
9 GND									
<p><b>WH-A52Z20-30E125:</b> Support printing of 240 dots width.</p> <div style="display: flex; justify-content: space-around; align-items: center;"> <div style="text-align: center;"> <p><b>HMI terminal 9pin D-SUB female</b></p>  <table border="1" style="margin: 10px auto;"> <tr> <td style="background-color: #ADD8E6;">com0/com1</td> <td style="background-color: #ADD8E6;">com2</td> </tr> <tr> <td>3 TX</td> <td>8 TX</td> </tr> <tr> <td>5 GND</td> <td>5 GND</td> </tr> </table> </div> <div style="text-align: center;"> <p><b>Bright Printer 10 pin port</b> Note:the red line is the first pin</p> <table border="1" style="margin: 10px auto;"> <tr> <td>5 RXD</td> </tr> <tr> <td>9 GND</td> </tr> </table> </div> </div>	com0/com1	com2	3 TX	8 TX	5 GND	5 GND	5 RXD	9 GND	<p>Serial port printing mode via RS232 level, short circuit as follows:</p> 
com0/com1	com2								
3 TX	8 TX								
5 GND	5 GND								
5 RXD									
9 GND									
<p><b>WH-A93RG0-00E825、WH-E393R101:</b> support printing of 384 dots width</p> <div style="display: flex; justify-content: space-around; align-items: center;"> <div style="text-align: center;"> <p><b>HMI terminal 9pin D-SUB female</b></p>  <table border="1" style="margin: 10px auto;"> <tr> <td style="background-color: #ADD8E6;">com0/com1</td> <td style="background-color: #ADD8E6;">com2</td> </tr> <tr> <td>3 TX</td> <td>8 TX</td> </tr> <tr> <td>5 GND</td> <td>5 GND</td> </tr> </table> </div> <div style="text-align: center;"> <p><b>Bright Printer 20 pin port</b> Note:the red line is the first pin</p> <table border="1" style="margin: 10px auto;"> <tr> <td>15 RXD</td> </tr> <tr> <td>19 GND</td> </tr> </table> </div> </div>	com0/com1	com2	3 TX	8 TX	5 GND	5 GND	15 RXD	19 GND	<p>Serial port printing mode via RS232 level, short circuit as follows:</p> 
com0/com1	com2								
3 TX	8 TX								
5 GND	5 GND								
15 RXD									
19 GND									

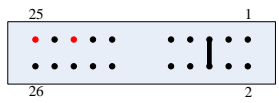
<b>WH-E173R90-00E11720GA:</b> support printing of 192 dots width.																		
	<table border="1"> <tr> <th colspan="2">HMI terminal 9pin D-SUB female</th> </tr> <tr> <td>com0/com1</td> <td>com2</td> </tr> <tr> <td>3 TX</td> <td>8 TX</td> </tr> <tr> <td>5 GND</td> <td>5 GND</td> </tr> </table>	HMI terminal 9pin D-SUB female		com0/com1	com2	3 TX	8 TX	5 GND	5 GND	<p><b>Bright Printer 20 pin port</b> Note:the red line is the first pin</p> <table border="1"> <tr> <td>19 RXD</td> </tr> <tr> <td>16 GND</td> </tr> </table>	19 RXD	16 GND						
	HMI terminal 9pin D-SUB female																	
com0/com1	com2																	
3 TX	8 TX																	
5 GND	5 GND																	
19 RXD																		
16 GND																		
<b>WH-E191RB0-00E1182055:</b> support printing of 576 dots width (24).																		
	<table border="1"> <tr> <th colspan="2">HMI terminal 9pin D-SUB female</th> </tr> <tr> <td>com0/com1</td> <td>com2</td> </tr> <tr> <td>3 TX</td> <td>8 TX</td> </tr> <tr> <td>5 GND</td> <td>5 GND</td> </tr> </table>	HMI terminal 9pin D-SUB female		com0/com1	com2	3 TX	8 TX	5 GND	5 GND	<p><b>Bright Printer 20 pin port</b> Note:the red line is the first pin</p> <table border="1"> <tr> <td>19 RXD</td> </tr> <tr> <td>16 GND</td> </tr> </table>	19 RXD	16 GND						
	HMI terminal 9pin D-SUB female																	
com0/com1	com2																	
3 TX	8 TX																	
5 GND	5 GND																	
19 RXD																		
16 GND																		
		<p>Serial port printing mode via RS232 level</p> <table border="1"> <tr> <td>20</td> <td>TXD</td> <td>RXD</td> <td>19</td> </tr> <tr> <td>18</td> <td>BUSY</td> <td>⊘</td> <td>17</td> </tr> <tr> <td>16</td> <td>GND</td> <td>⊘</td> <td>15</td> </tr> <tr> <td></td> <td>⋮</td> <td>⋮</td> <td></td> </tr> </table>	20	TXD	RXD	19	18	BUSY	⊘	17	16	GND	⊘	15		⋮	⋮	
20	TXD	RXD	19															
18	BUSY	⊘	17															
16	GND	⊘	15															
	⋮	⋮																
<b>WH-C13RA9-00E82B:</b> support printing of 384 dots width, and with automatic cutting function																		
	<table border="1"> <tr> <th colspan="2">HMI terminal 9pin D-SUB female</th> </tr> <tr> <td>com0/com1</td> <td>com2</td> </tr> <tr> <td>3 TX</td> <td>8 TX</td> </tr> <tr> <td>5 GND</td> <td>5 GND</td> </tr> </table>	HMI terminal 9pin D-SUB female		com0/com1	com2	3 TX	8 TX	5 GND	5 GND	<p><b>Bright Printer 26 pin port</b> Note:the red line is the first pin</p> <table border="1"> <tr> <td>21RXD</td> </tr> <tr> <td>25GND</td> </tr> </table>	21RXD	25GND						
	HMI terminal 9pin D-SUB female																	
com0/com1	com2																	
3 TX	8 TX																	
5 GND	5 GND																	
21RXD																		
25GND																		
		<p>Serial port printing mode via RS232 level, short circuit as follows:</p> 																
<b>WH-M073R101</b>																		
Use the built-in communication line		Baud : 115200																

**2.1.3 Siupo Printer cable**

a. SP-E40004SK serial printer supports 240 dots width.

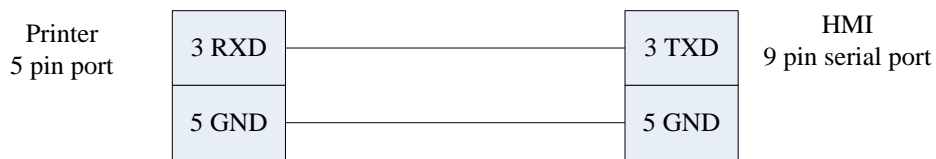

**2.1.4 MY POS Printer cable**

a. MY-POS80K serial printer which supports 240 dots width. 25 pin.



**2.1.5 SPRT Printer cable**

Printer Type	Note
SP-RMDIIDSH: support printing of 384 dots width	

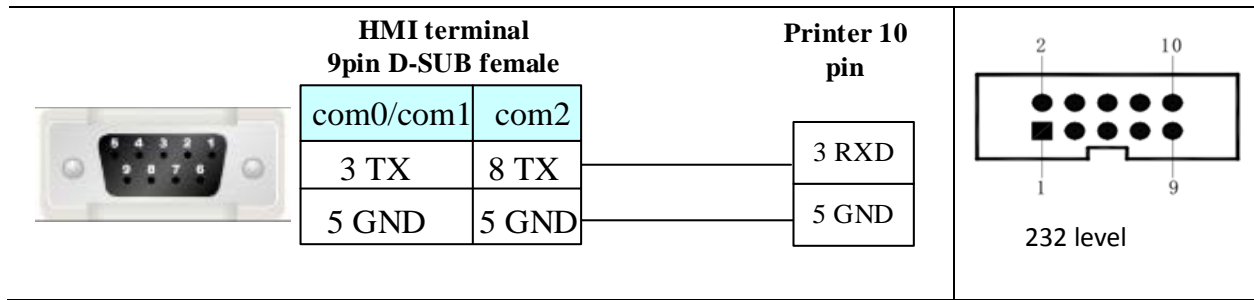

2.1.6 RD Printer cable

Printer Type	Note
RD-DH32-S5: support printing of 384 dots width	

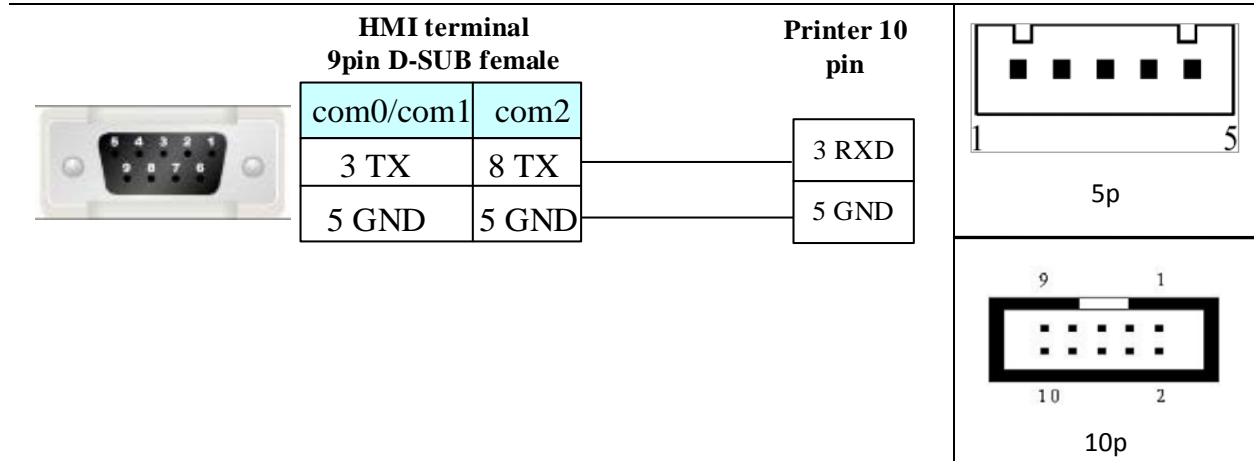

2.2 Recommend Optional printer

Printer Driver	Printer model	Interface	Print Structure	Print format
WH4008A31-053	WH-A52Z20-30E125	serial	Stylus micro printer	240 dots/line
	WH-A52Z20-40E125	serial	Stylus micro printer	240 dots/line
	WH-E20Z220-50E0022T55	serial	Stylus micro printer	240 dots/line
WH-A62R10	WH-A62R10-41E725	Serial	thermal	192 dots/line
	WH-A93RG0-00E725	Serial	thermal	192 dots/line
	WH-E173R90-00E11720GA	Serial	thermal	192 dots/line
WH-A93RG0-00E825	WH-A93RG0-00E825	Serial	thermal	384 dots/line
	WH-T2AR10-30E82B	Serial	Thermal POS	384 dots/line
WH-E191RB0-00E1182055	WH-E191RB0-00E1182055	Serial	thermal	576 dots/line
WH-E393R101	WH-E393R101-00A00B2TBA	Serial	thermal	
WH-E461RB01	WH-E461RB01-00A00B2UBA	Serial	thermal	
WH-M073R101	WH-M073R101-00E00C20BA	USB host	thermal	
Siupo SP-M, D, E, F	SP-E4004SK	Serial	Stylus micro printer	240 dots/line
SP-RMDIIIDSH	SP-RMDIIIDSH_S13AS	Serial	thermal	384 dots/line
MY-POS80K	MY-POS80K	Serial	thermal POS	240 dots/line
HP LaserJet P1108	HP LaserJet P1108	USB host	Laser	A4
HP LaserJet 1020 plus	HP LaserJet 1020 plus	USB host	Laser	A4
EPSON ESC/P2	LQ-310	USB host	Dot Matrix Strike	A4



---

	LQ-630K			
EPSON LX-310	EPSON LX-310	USB host	Dot Matrix Strike	A4
Gainscha	Gainscha GP-1124T	USB host	Ink-jet	---
RD-DH32-S5	RD-DH32-S5_545xcjb2v1	Serial	Thermal micro-printer	384 dots/line

### 3 Download Cable Diagram

#### 3.1 Download by Serial Port

The COM2 port on the back of the case can be used to connect PLC RS-232 devices and can also be used to connect with the programming interface and setting interface of a PC.

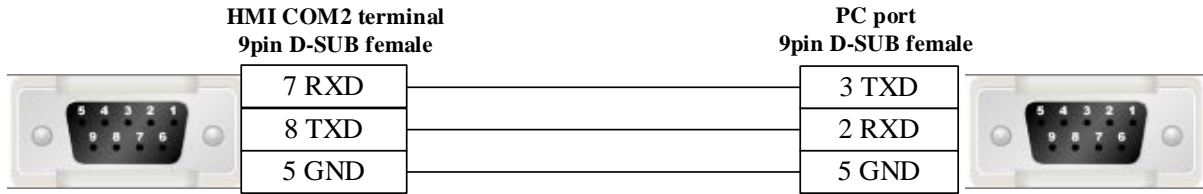

#### 3.2 Download by USB

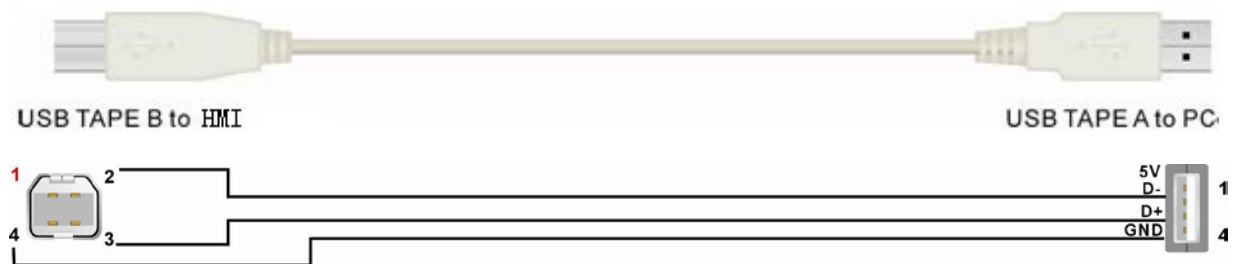

#### 3.3 Download by Network Ethernet

Connecting PC and HMI use cross-ruling; communicating with hub or switch use Cross-over cable or cross-ruling.

##### A. cross-ruling cable diagram:

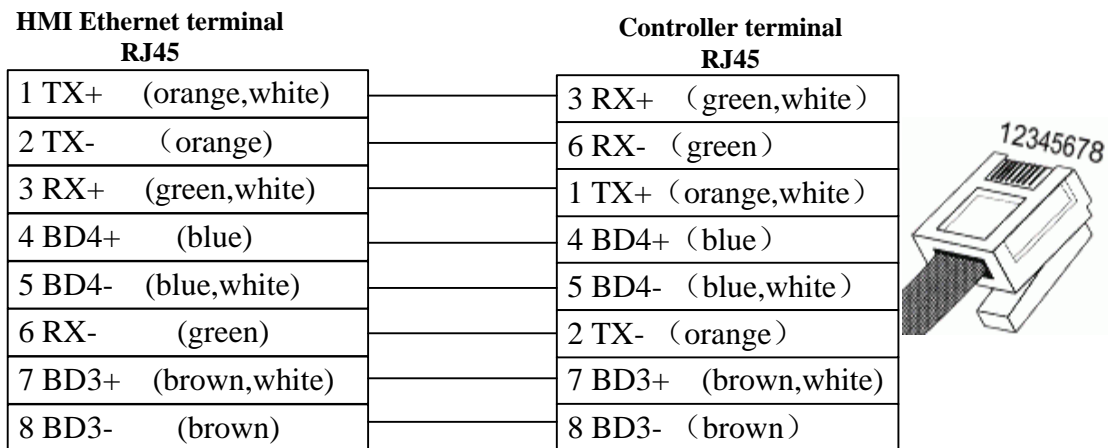

##### B. cross-over cable diagram:

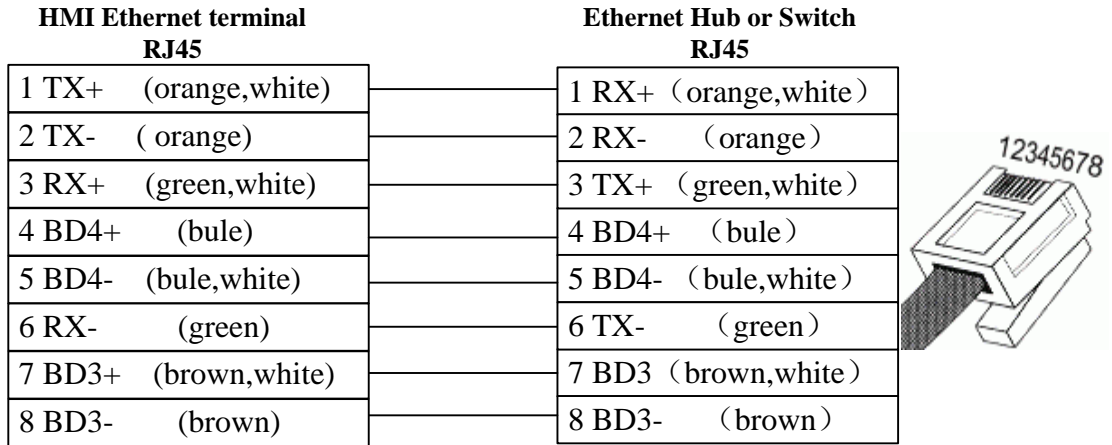

## 4 Communication Settings and guide of HMI connecting with Controller

**Note: Do not hot plug!**

### 4.1 ABB Corporation

#### ◎ Serial Communication

Series	CPU	Link Module	Driver
ABB AC31	O7KR51-V3.6	RS232 on the CPU unit	ABB AC31 Modbus RTU
		RS485	
ABB AC500	PM571 PM581 PM591	RS232 on the CPU unit	ABB AC500

#### ◎ Network Communication

Series	CPU	Link Module	Driver
ABB AC500	PM583	CPU Direct	ABB AC500 Modbus TCP Slave

#### ◎ System configuration

Series	CPU	Link Module	COMM Type	Parameter	Cable
ABB AC31	O7KR51-V3.6	RS232 on the CPU unit	RS232	<a href="#">Setting</a>	<a href="#">Your owner cable</a>
		RS485	RS485	<a href="#">Setting</a>	<a href="#">Your owner cable</a>
ABB AC500	PM571 PM581 PM591	RS232 on the port 1	RS232	<a href="#">Setting</a>	<a href="#">Your owner cable</a>
		RS232 on the port 2	RS232	<a href="#">Setting</a>	<a href="#">Your owner cable</a>

#### ◎ Network Communication Settings

Series	CPU	Link Module	Connect Type	Parameter	Cable
ABB CPU	PM583	CPU Direct	Ethernet	<a href="#">Setting</a>	<a href="#">Your owner cable</a>

#### ◎ Serial Communication Settings

##### HMI Setting

##### ABB AC31 Modbus RTU protocol:

Default communication parameters 9600, 8, none, 1; station No. : 1

[RS232](#)

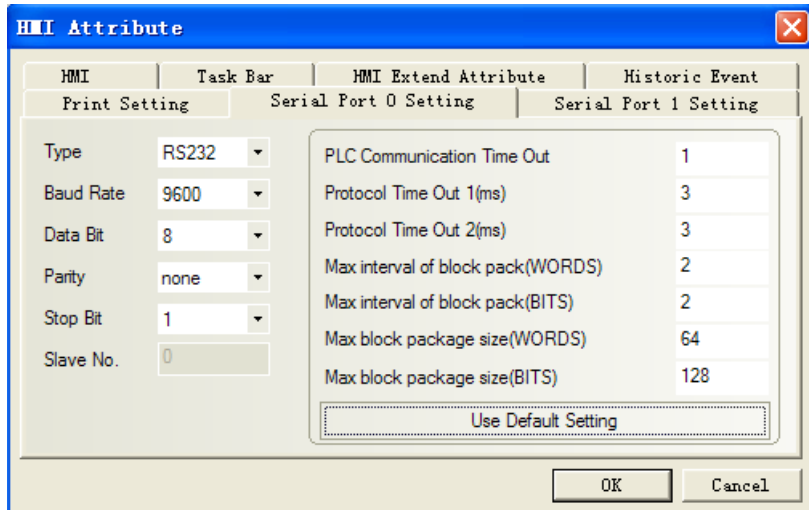

RS485

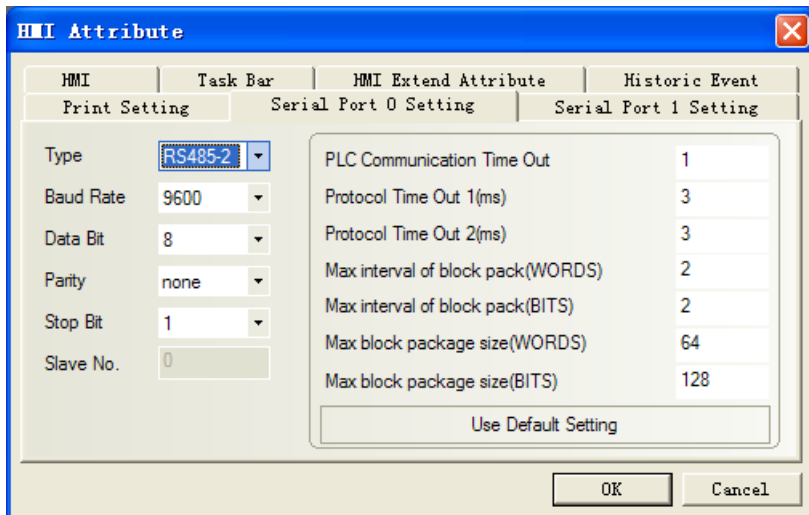

**ABB AC500 protocol:**

Default communication parameters 9600, 8, none, 1; station No. : 1

RS232

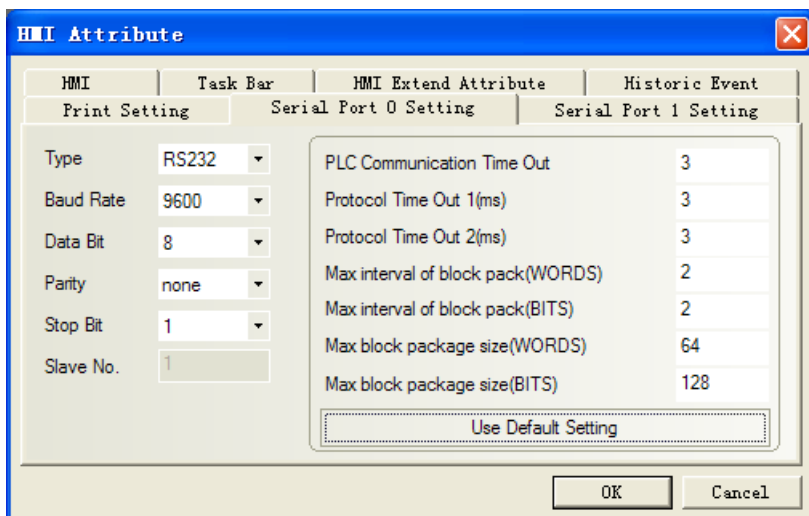

## PLC Settings

Related parameters settings refer to the communication equipment specifications.

## Network Communication parameters Settings

### HMI Settings

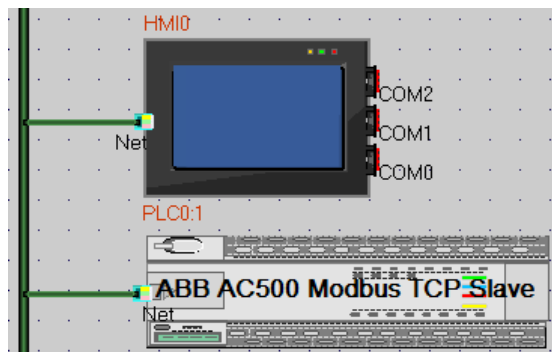

Device	IP Addr	Port	Protocol	Master/...	Stati...	Virtual...
HMI0	192.168.0.100	502	ABB AC5...	M		
PLC0	192.168.0.2	502	ABB AC5...	S	1	

Buttons: Add, Delete, Delete All, Modify, OK

### PLC 设置

IP setting can use control builder plus or panel setting, specific reference to ABB help.

## ◎ Supported Device

### ABB AC31

Device	Bit Address	Word Address	Format
Input bit	I00.00-624.15	-----	DD.DD
Output bit	O00.00-624.15	-----	DD.DD
Internal Relay	M(0.0--99.15)U(233.00-255.15)	-----	DDD.DD
Link Relay	S000.00-624.15	-----	DDD.DD
Input Register	-----	IW00.00-624.15	DD.DD
Output Register	-----	OW00.00-624.15	DD.DD
Internal Register	-----	MW(0.0--99.15)U(233.00-255.15)	DDD.DD
Indirect Register	-----	KW01.00-624.15	DD.DD
Internal Register (Double words)	-----	MD0.00-624.15	D.DD
Indirect Register (Double words)	-----	KD0.00-624.15	D.DD

### ABB AC500

Device	Bit Address	Word Address	Format
--------	-------------	--------------	--------

PLC Register	MB0.0—12499.7	-----	DDDD.O
Internal Register	-----	MW0.0—3.01695	D.DDDDD
Internal Register (Double words)	-----	MD0.0—6.01695	D.DDDDD

**Note:**

- 1) Select “**MODBUS**” mode in the ABB AC500 programming software;
- 2) If selecting “COM1 MODBUS”, serial communication setting must be “**slave**” in the 15th “**Operation mode**”. Other parameters match the touch-screen.
- 3) Example: **MB address: 0.0.1**, please input **0.1** in the HMI.

© **Cable Diagram**

**ABB AC31 RS232**

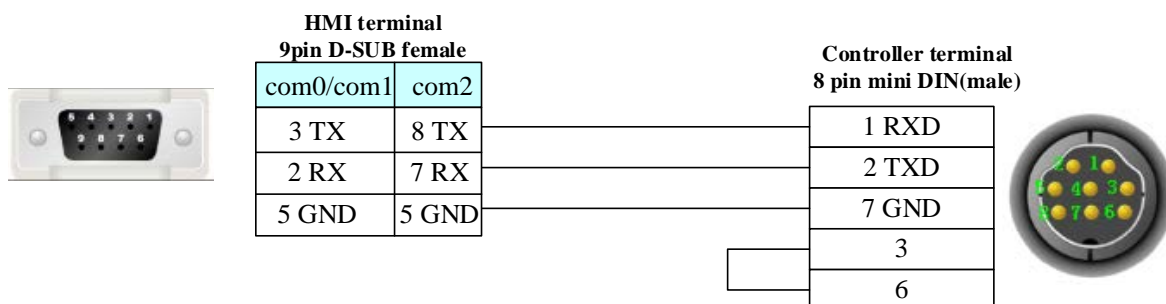

**ABB AC31 RS485**

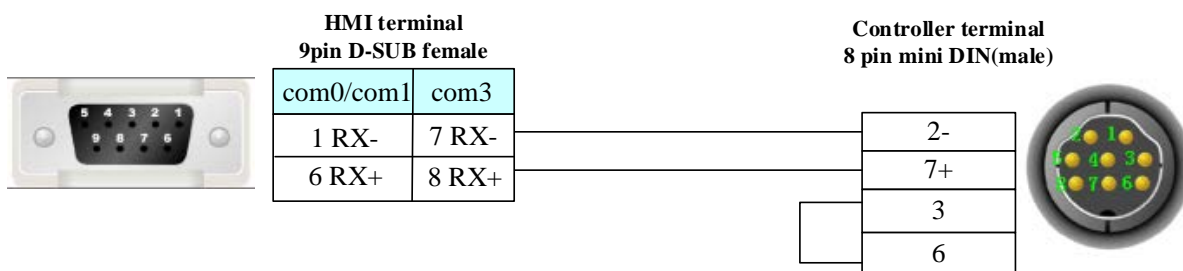

**ABB AC500 port1 RS232**

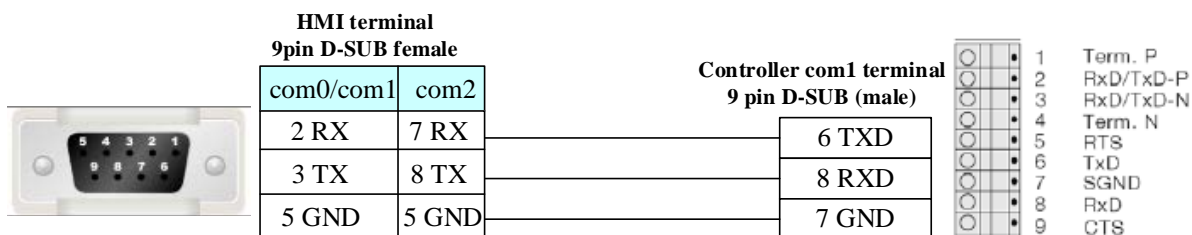

**ABB AC500 port2 RS232**

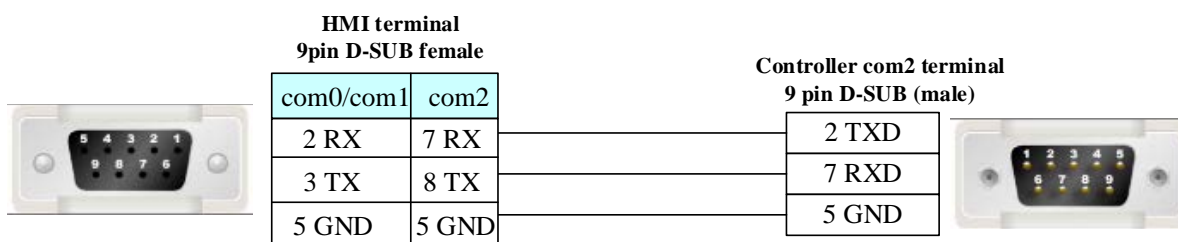

## 4.2 Allen-Bradley

### ◎ Serial Communication

Series	CPU	Link Module	Driver	
MicroLogix	MicroLogix 1500 (1764-LRP)	Channel 1	AB SLC500/PLC5/MicroLogix Series(DF1)*1	
	MicroLogix 1000	Channel 0		
	MicroLogix 1200	AIC+ Advanced		
	MicroLogix 1500 (1764-LSP,1764-LRP)	Interface Converter 1761-NET-AIC		
	MicroLogix 1400 (1766-L32BWAA)	Channel 0		
SLC500	SLC 5/03 SLC 5/04 SLC 5/05	Channel 2		
		Channel 0		
		1770-KF3		
		2760-RB		
		1775-KA		
PLC-5	PLC-5/11 PLC-5/20 PLC-5/30 PLC-5/40 PLC-5/40L PLC-5/60 PLC-5/60L	5130-RM		
		1771-KGM		
		Channel 0		
		Channel 0		
		Channel 0		
		Channel 0		
		Channel 0		
CompactLogix	1769-L20 1769-L30 1769-L31 1769-L32E 1769-L35E	Channel 0 Channel 1	AB CompactLogix/ControlLogix Series(DF1)*2	
			AB CompactLogix_ControlLogix(Free tag Names)	
			ControlLogix	CPU Direct
			1756-L61 1756-L63	
			Micro850	2080-LC50-24AWB 2080-LC50-24QBB 2080-LC50-24QVB 2080-LC50-24QWB 2080-LC50-24QBB 2080-LC50-24QBB 2080-LC50-24QBB

\*1 Suitable for the PLC that uses RSLinx500 program software

\*2 Suitable for the PLC that uses RSLinx5000 program software

\*3 Suitable for the ccw program software.



### ◎ Ethernet Communication (Direct Online Simulation disable)

Series	CPU	Link Module	Driver		
MicroLogix	MicroLogix 1100 MicroLogix 1400	CPU Direct (channel 1)	AB SLC500/PLC5/MicroLogix Series Ethernet(TCP Slave) *1		
	MicroLogix 1000 MicroLogix 1100 MicroLogix 1200 MicroLogix 1400 MicroLogix 1500	1761-NET-ENI			
	SLC500	SLC5/05		CPU Direct (channel 1)	
		SLC5/03 SLC5/04 SLC5/05		1761-NET-ENI	
		PLC-5		ALL CPUs that support the link I/F on the right	1761-NET-ENI
		CompactLogix		1769-L30ER 1769-L32E 1769-L35E	CPU Direct
All CPUs which support the link I/F on the right	1761-NET-ENI		AB CompactLogix/ControlLogix Series Ethernet(Free Tag Names)(TCP Slave)		
Micro850	2080-LC50-24AWB 2080-LC50-24QBB 2080-LC50-24QVB 2080-LC50-24QWB 2080-LC50-24QBB 2080-LC50-24QBB 2080-LC50-24QBB	CPU Direct	AB Micro850 Ethernet(TCP Slave)		

\*1 Suitable for the PLC that uses RSLinx500 program software

\*2 Suitable for the PLC that uses RSLinx5000 program software

### ◎ Serial System Communication

Series	CPU	Link Module	COMM Type	Parameter	Cable
MicroLogix	1500 (1764-LRP)	Channel 1	RS232C	<a href="#">Setting</a>	<a href="#">Your owner cable</a>
	MicroLogix 1000 MicroLogix 1200 MicroLogix 1500	Channel 0	RS232C	<a href="#">Setting</a>	<a href="#">Your owner cable</a>
		AIC+ Advanced Interface Converter 1761-NET-AIC			
	MicroLogix 1400	Channel 0	RS232C	<a href="#">Setting</a>	<a href="#">Your owner cable</a>
Channel 2					
SLC500	SLC 5/03 SLC 5/04	Channel 0	RS232C	<a href="#">Setting</a>	<a href="#">Your owner cable</a>
		1770-KF3			

	SLC 5/05	2760-RB 1775-KA 5130-RM 1771-KGM			
PLC-5	PLC-5/11 PLC-5/20 PLC-5/30 PLC-5/40 PLC-5/40L PLC-5/60 PLC-5/60L	Channel 0	RS232C	<a href="#">Setting</a>	<a href="#">Your owner cable</a>
CompactLogix	1769-L20 1769-L30 1769-L31 1769-L32E 1769-L35E	Channel 0 Channel 1	RS232C	<a href="#">Setting</a>	<a href="#">Your owner cable</a>
ControlLogix	1756-L61	CPU Direct	RS232C	<a href="#">Setting</a>	<a href="#">Your owner cable</a>
Micro850	2080-LC50-24Q WB	CPU Port	RS232C	<a href="#">Setting</a>	<a href="#">Your owner cable</a>

### ◎ Ethernet System Communication

Series	CPU	Link Module	Connect Type	Parameter	Cable
MicroLogix	MicroLogix 1100 MicroLogix 1400	CPU Direct (channel 1)	Ethernet	<a href="#">Setting</a>	<a href="#">Your owner cable</a>
	MicroLogix 1000 MicroLogix 1100 MicroLogix 1200 MicroLogix 1500	1761-NET-ENI			
SLC500	SLC505	CPU Direct(channel 1)			
	SLC503 SLC504 SLC505	1761-NET-ENI			
PLC-5	ALL CPUs that support the link I/F on the right	1761-NET-ENI			
CompactLogix	1769-L30ER 1769-L32E 1769-L35E	CPU Direct	Ethernet	<a href="#">Setting</a>	<a href="#">Your owner cable</a>
	All CPUs which support the link I/F on the right	1761-NET-ENI			
Micro850	2080-LC50-24AWB 2080-LC50-24QBB 2080-LC50-24QVB 2080-LC50-24QWB 2080-LC50-24QBB	CPU Direct	Ethernet	<a href="#">Setting</a>	<a href="#">Your owner cable</a>

	2080-LC50-24QBB				
	2080-LC50-24QBB				

◎ Serial Communication Setting

AB SLC500/PLC5/MicroLogix Series protocol

HMI Setting

Default communication parameters 19200, 8, none, 1; station No. : 0

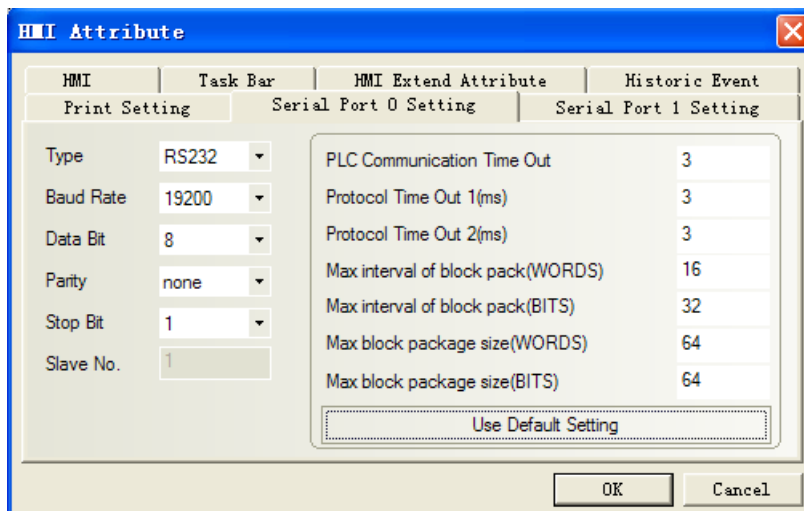

PLC Setting

RSLogix500 software setting

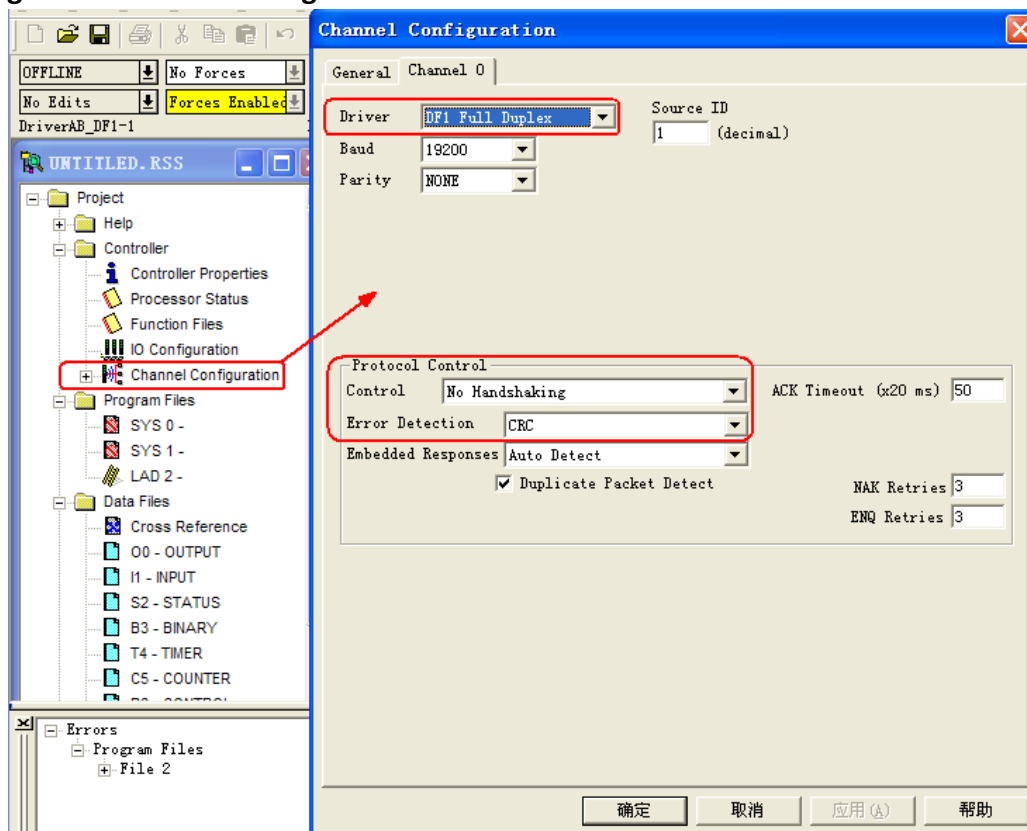

**NOTE:** Driver: DF1 Full Duplex; Error Detection: CRC.

AB CompactLogix/ControlLogix Series protocol

## HMI Setting

Default communication parameters 19200, 8, none, 1; station No. : 0

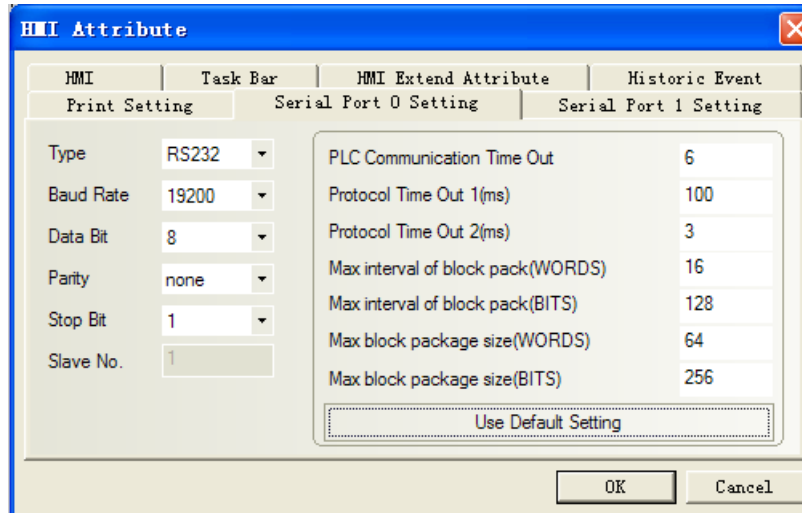

## PLC Setting

### RSLogix5000 software setting

**NOTE:** Protocol: DF1 Point to Point; Error Detection: CRC; Enable Duplicate Detection: Disabled.

(1) **Set the communication parameters:** Controller properties

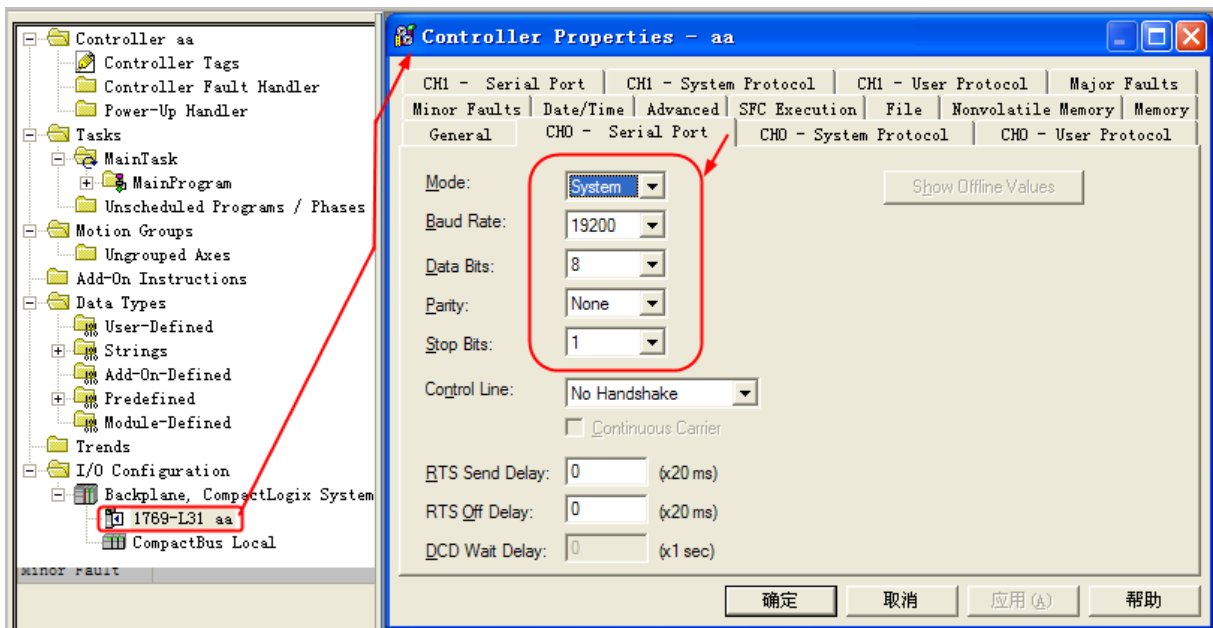

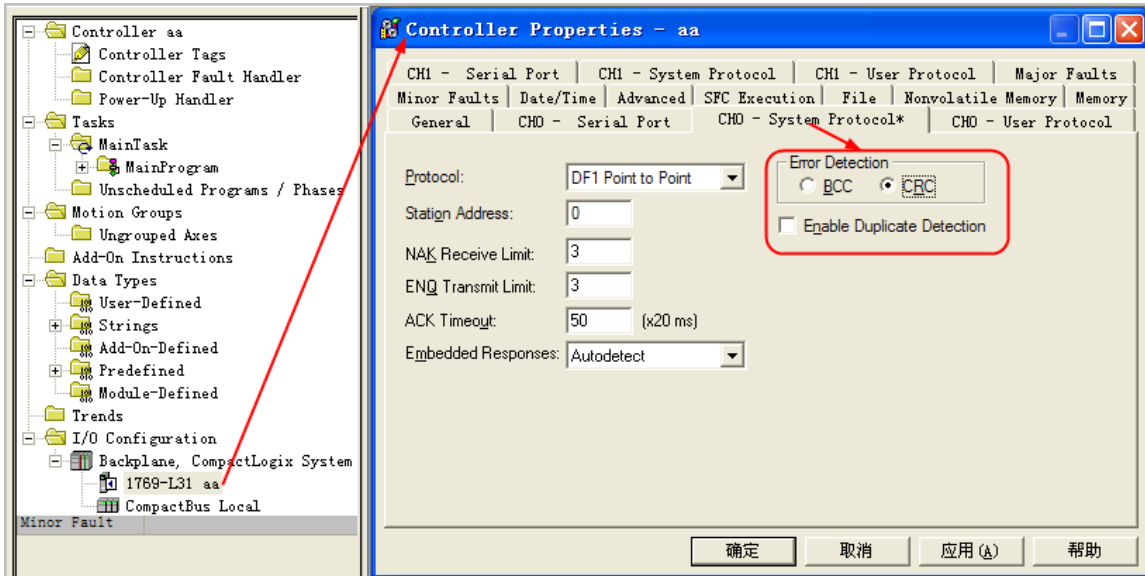

**NOTE:** Define the new device in the RSLogix5000 before using the register in the HMI.

(2) **Define Tags and Data type:** Select “Controller Tags” right-click→”New Tag”, set up tag:

**NOTE:**

1. The controller registers that HMI needs to visit should be defined in the RSLogix5000 in advance.
2. Controller Tags are suitable for all routines in controller, they are global, so the tag should be built in Controller Tags

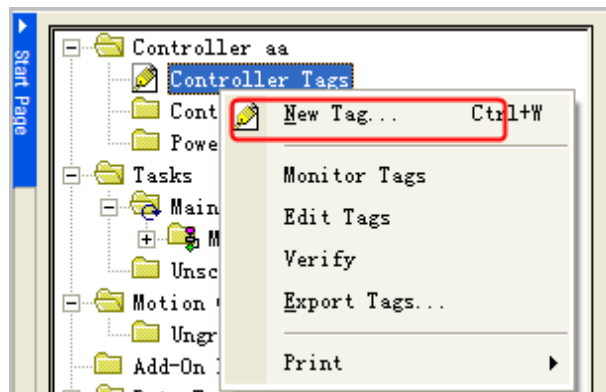

(3) **Tag Name and File Number mapping:** Select “Logic”→”Map PLC/SLC Messages”. (Note: the software should be in offline mode)

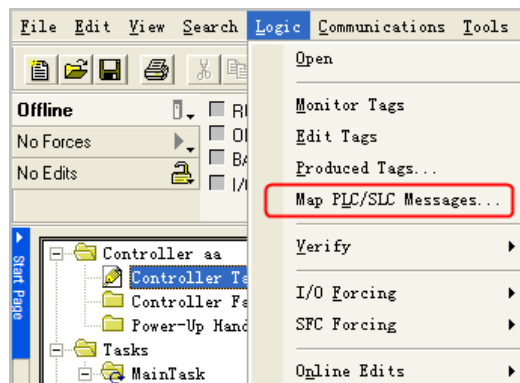

**Example:**

Build a new tag whose name is a, the Data Type is INT:

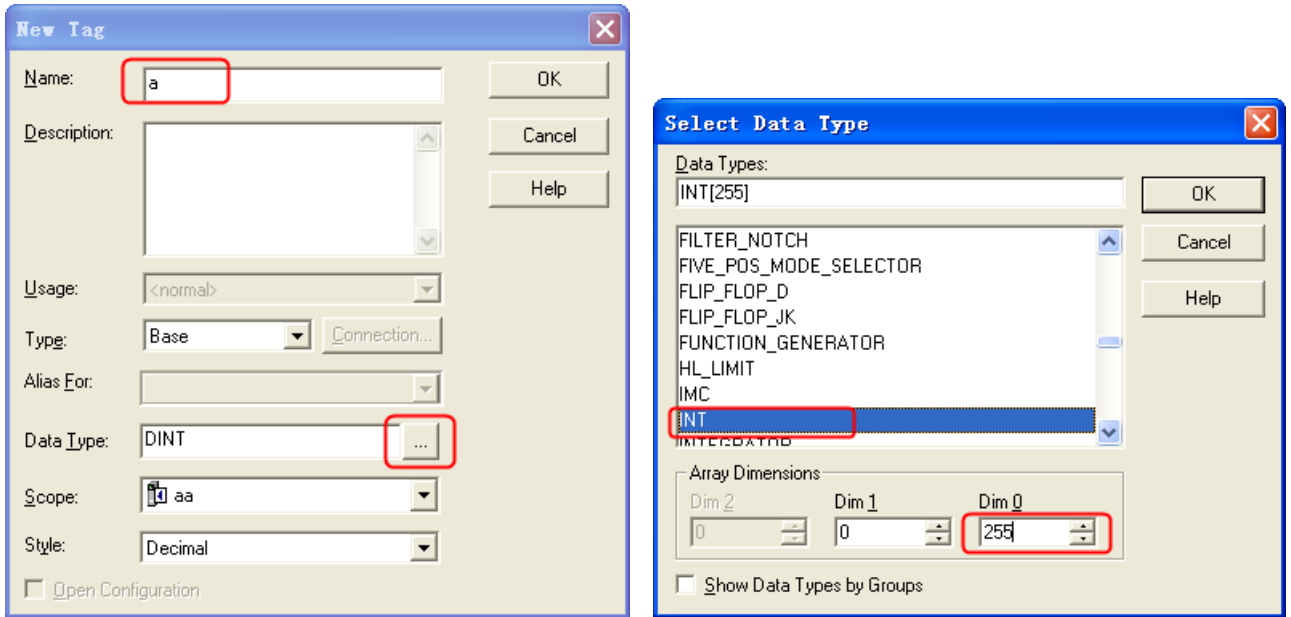

**Note:**

1. For the Data Type, the CompactLogix/ControlLogix supports the INT, BOOL, REAL data type only.
2. This driver does not support Multi-dimensional array, so you can define the range of Dim0 only.
3. In this driver, the INT range is 0~254; REAL range is 0~254, and the BOOL range is 0~999.

Besides, build two new tags whose Names are b and c, Data Type are REAL and BOOL.

Name	Value	Force Mask	Style	Data Type	Description
+ a		{...}	Decimal	INT[255]	
+ b		{...}	Float	REAL[255]	
+ c		{...}	Decimal	BOOL[1024]	

The BOOL variable address range is 0~1024 in PLC, but this driver only supports 0~999. So the HMI can only visit the BOOL register from to 999.

After the tags are defined, map the Name to the File Number:

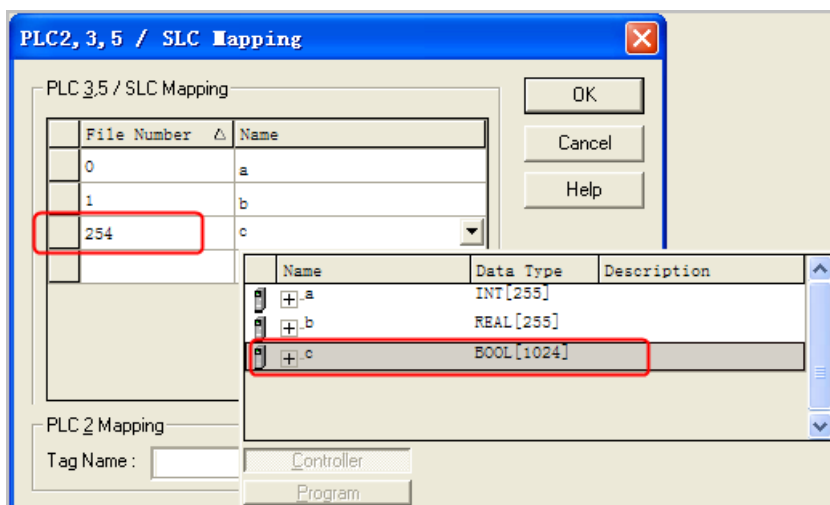

**Note:**

1. The File Number is unique, a same File Number cannot map to different Names
2. The range of File Number in this driver is 0~254.

The HMI mapping addresses are as follows:

Tag Name	Data Type	Support Range	Mapping File Number	Mapping HMI address
a	INT[255]	0~254	0	INT 000000~000254
a	BOOL	000.0~254.15	0	N_BOOL 000000.00~000254.15
b	REAL[255]	0~254	1	REAL 001000~001254
c	BOOL[1024]	0~999	254	B_BOOL 254000~254999

### AB CompactLogix/ControlLogix (Free tag Names) protocol:

#### HMI Setting

Default communication parameters 19200, 8, none, 1; station No. : 0

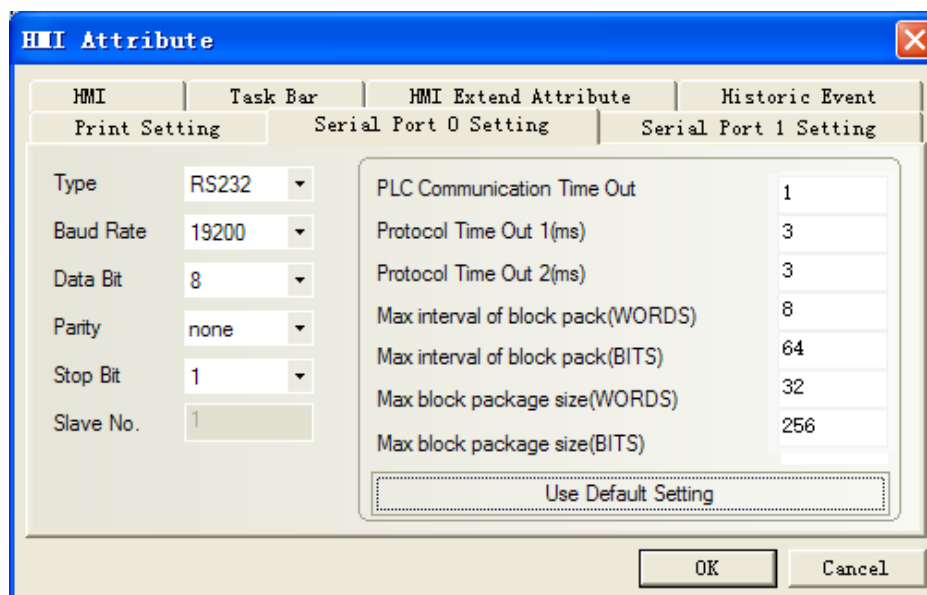
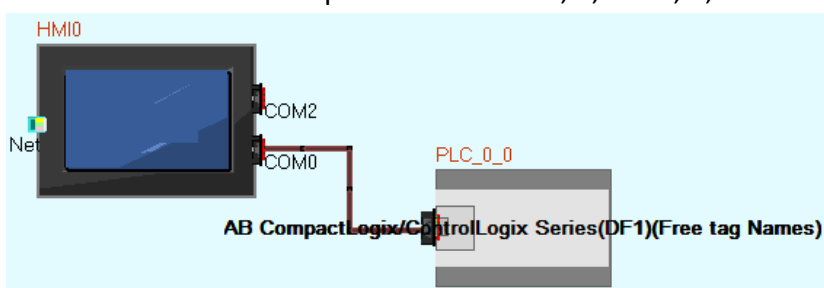

Double click "Label Editor", chose import tags

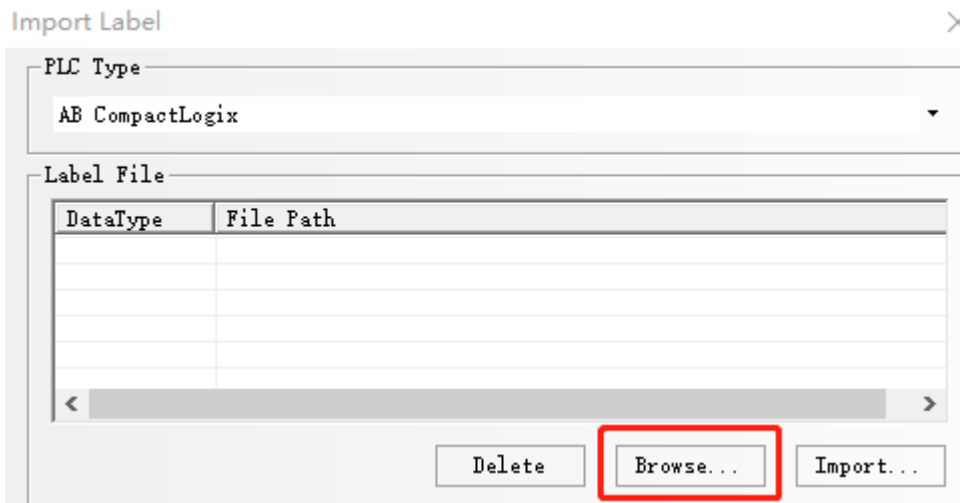
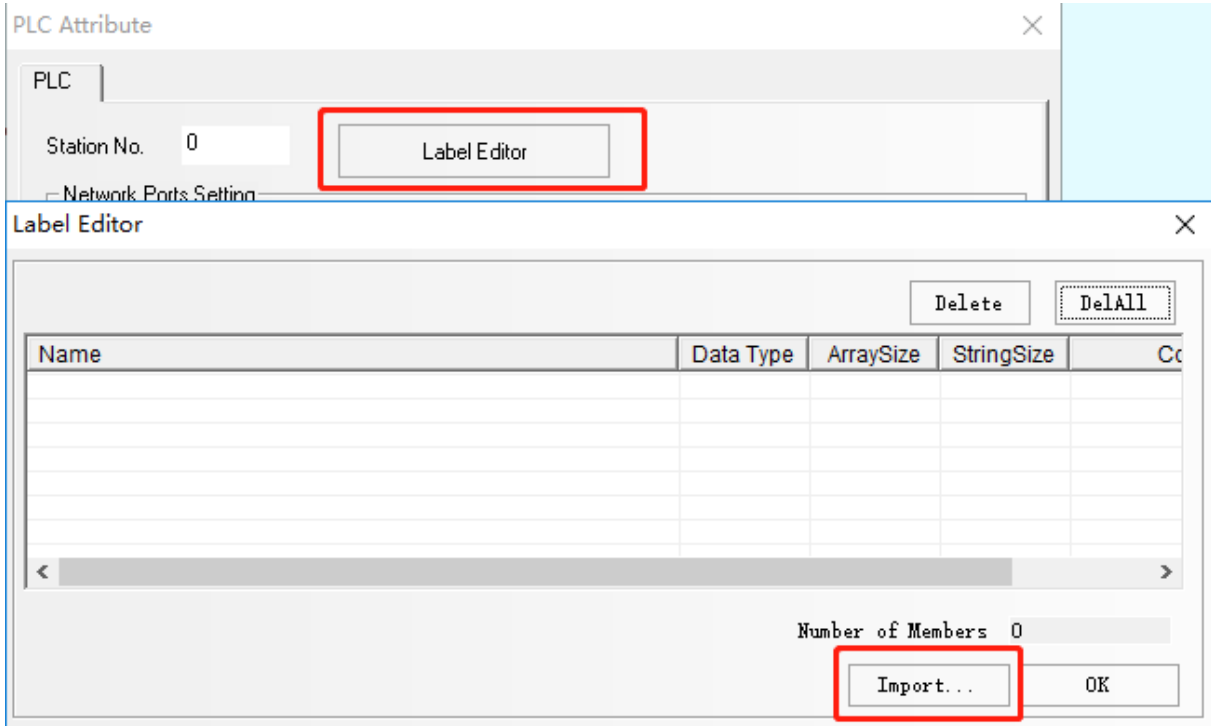



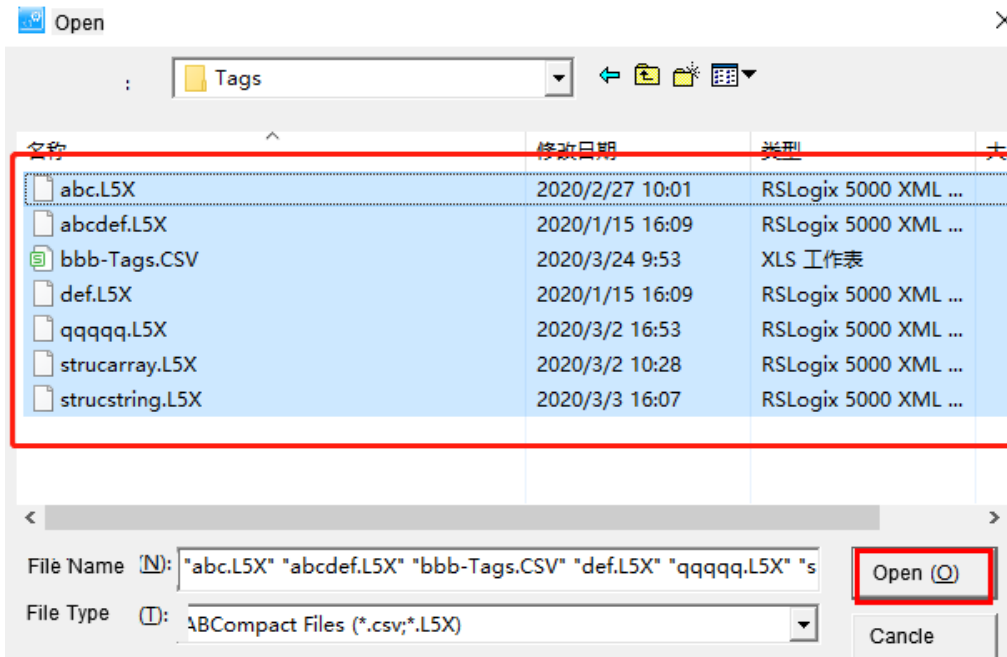

Batch import label CSV and L5X label files exported by PLC software (2 files generated by PLC programming software: L5X is a structure type file, and CSV is a label file)

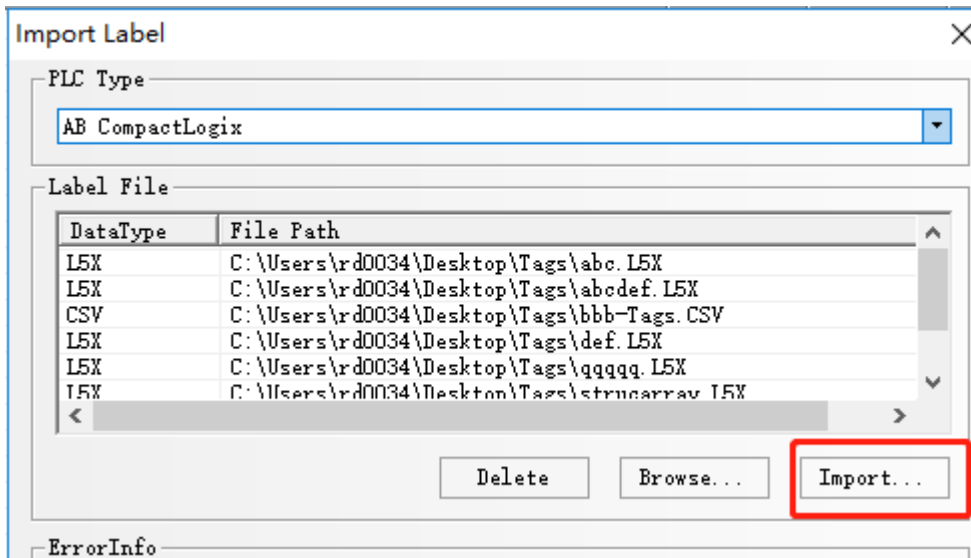

## PLC Setting

RSLogix5000 Software settings:

- 1) **Set the communication parameters:** Controller Properties

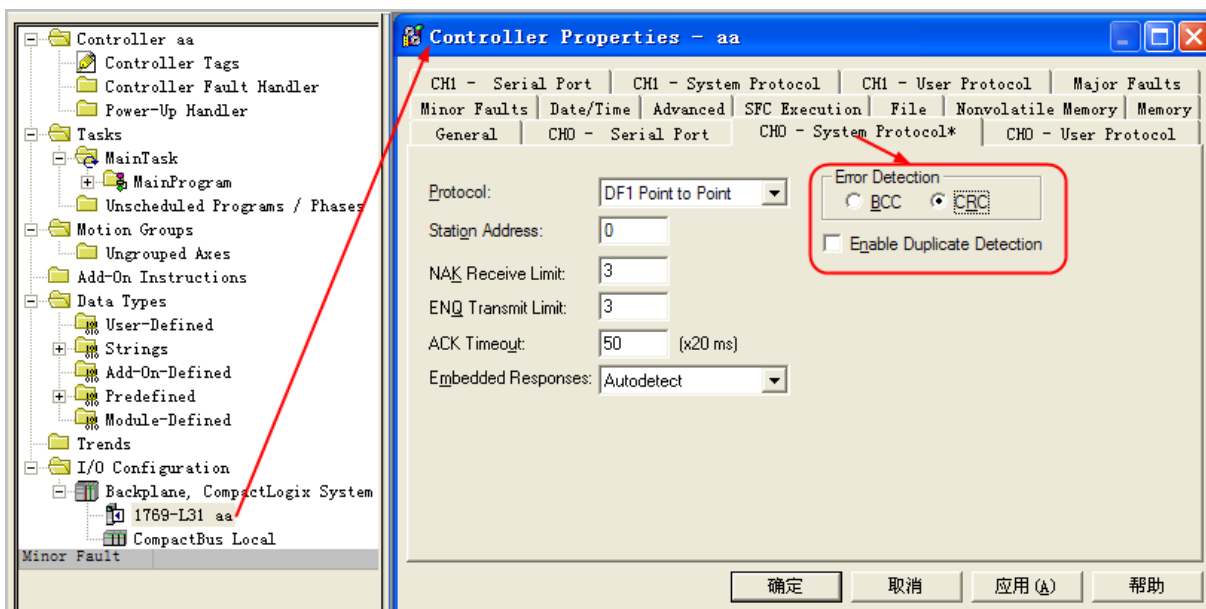
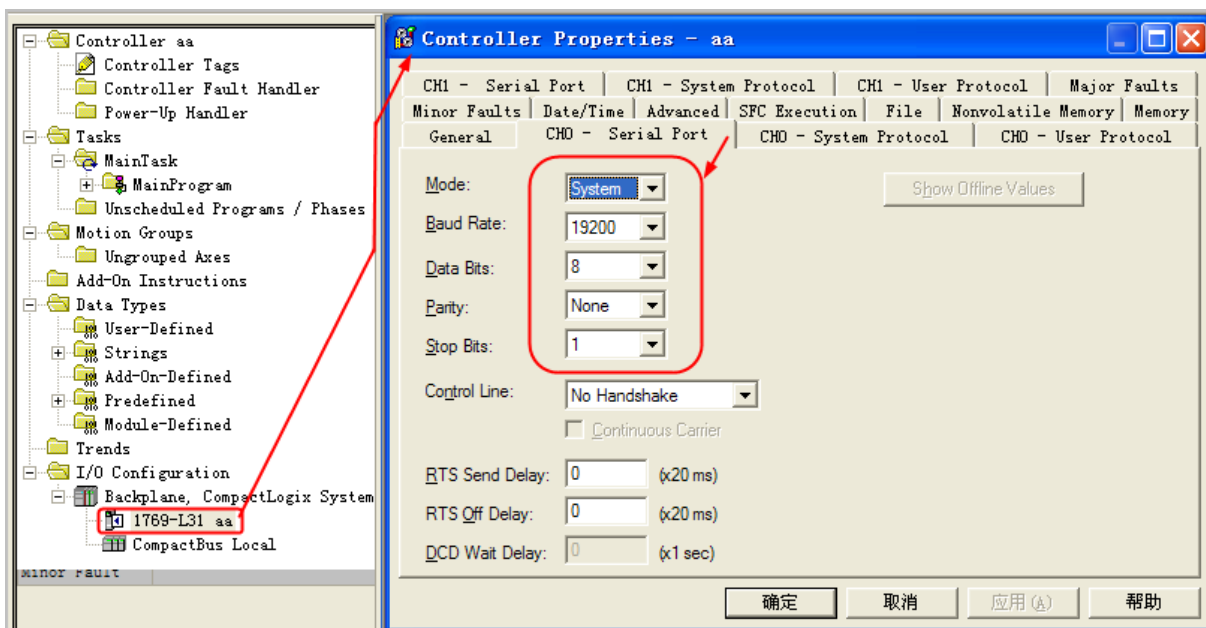

注意设置：Protocol：DF1 Point to Point；Error Detection：CRC；Enable Duplicate Detection：不勾选

(2) Label setting：Controller Tags

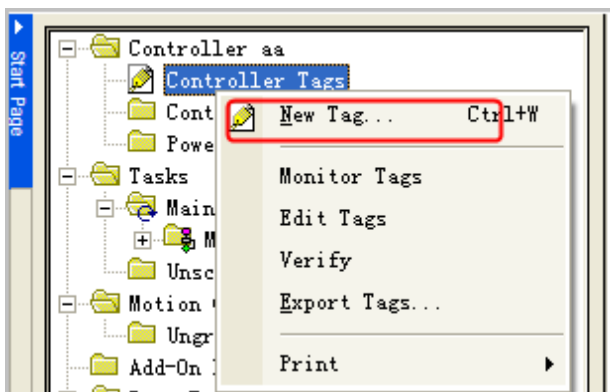

1. Common label

Create a new tag directly in the tag editor. This only needs to export the CSV to communicate directly with the screen.

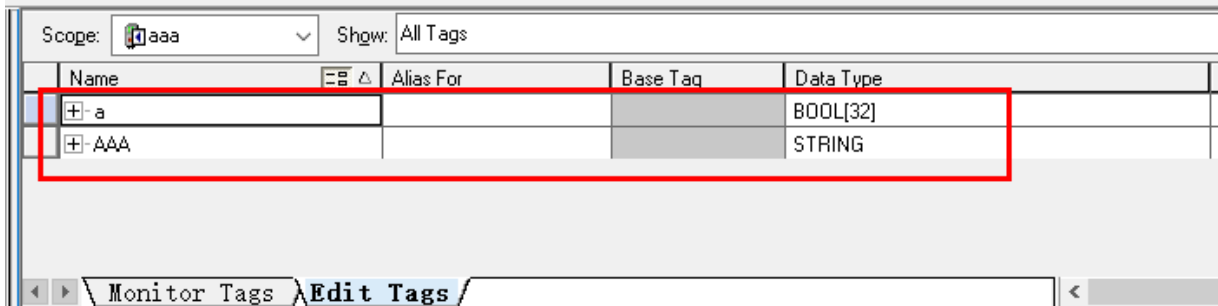

2. User-Defined tag (Structure tag)

As shown: Structure type "abc": After creating the data type "abc", you need to add a tag in the tag editor and reference the type. For example, add a new tag named "strucabc" to reference the structure type "abc".

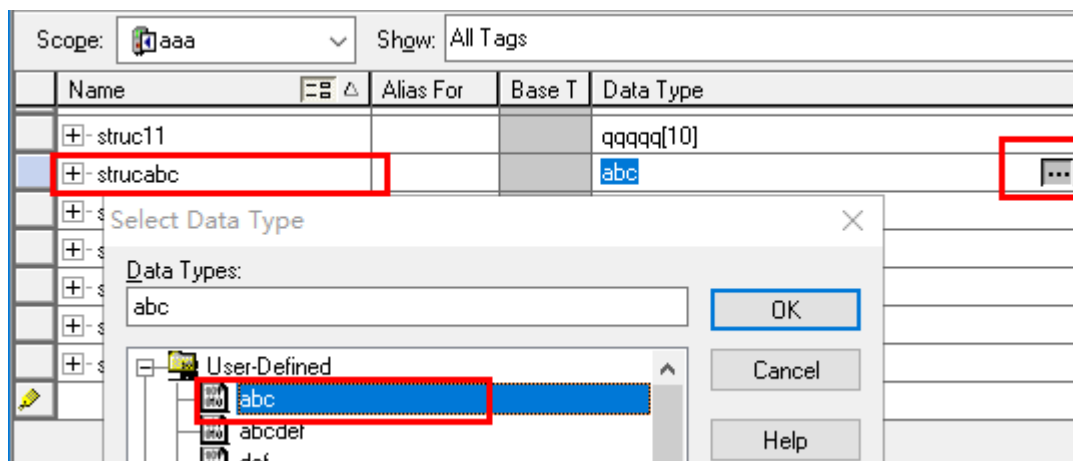
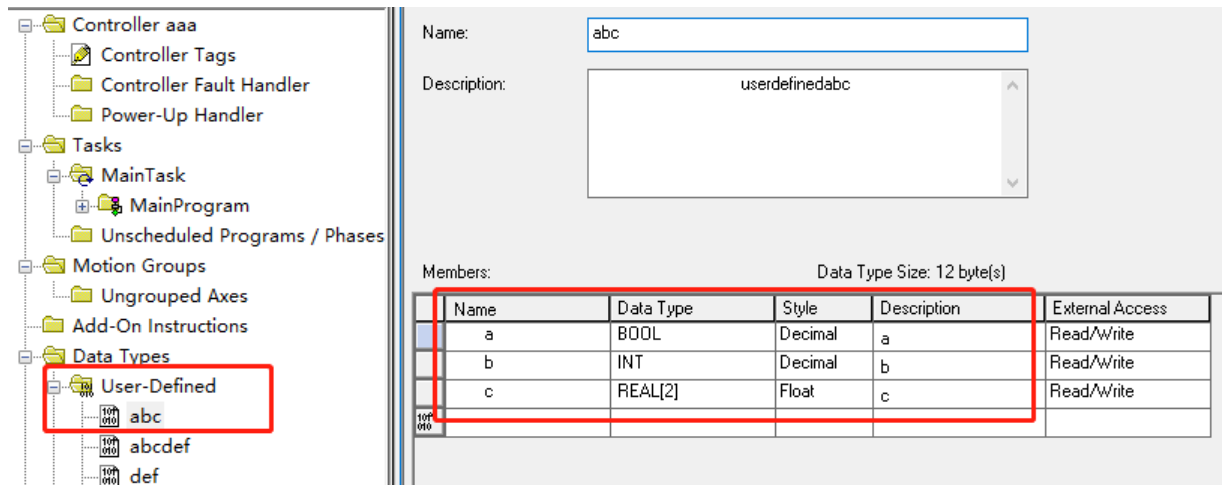

- strucabc			abc	userdefinedabc	R
- strucabc.a			BOOL	userdefinedabc a	F
+ strucabc.b			INT	userdefinedabc b	F
+ strucabc.c			REAL[2]	userdefinedabc c	F
+ strucabcdef			abcdef		R

For this type of structure type label, you need to import not only the label CSV to the project of the

screen, but also the structure L5X file:

Rightclick"abc"to export data type

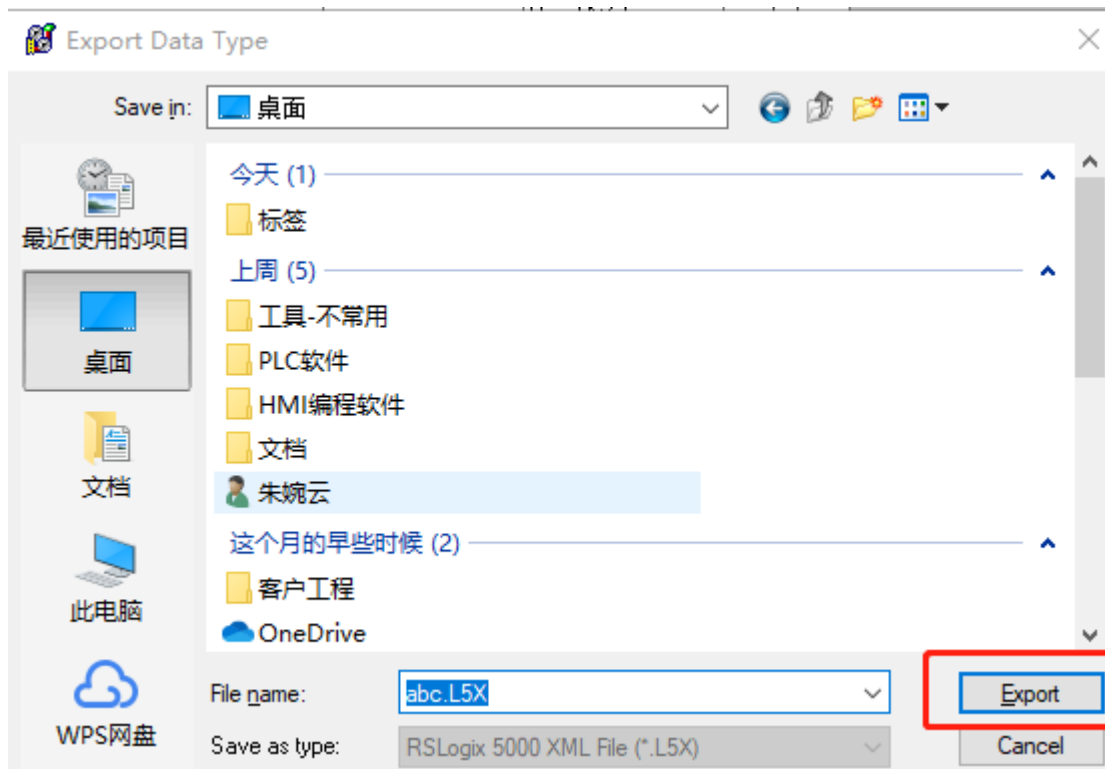
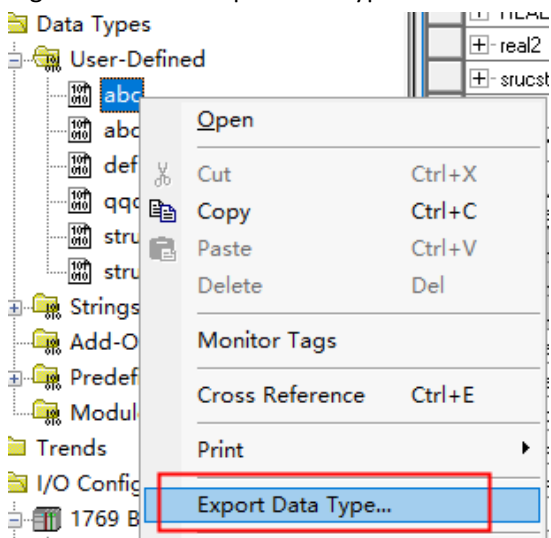

After editing all tags, click Tools-export-tags and logic comments to export the tags CSV file

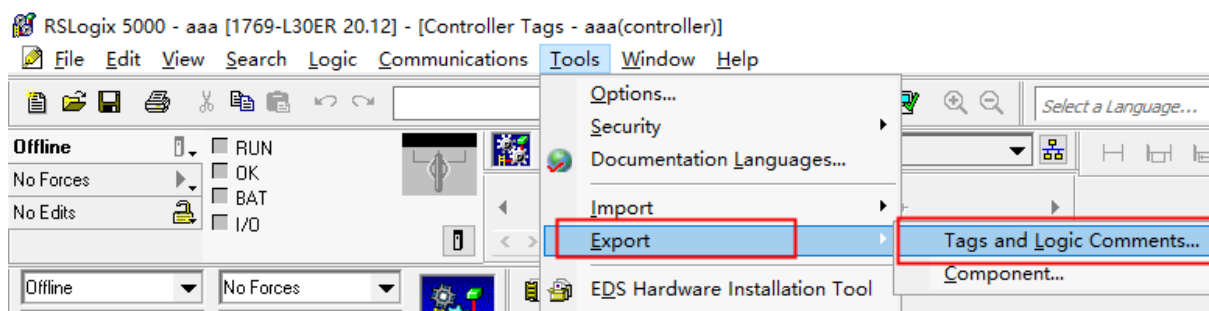

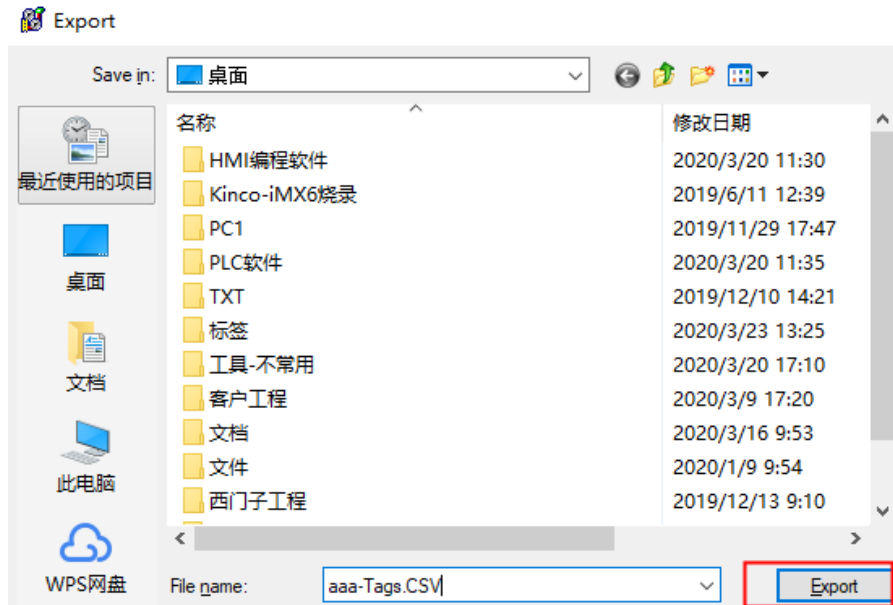

**AB Micro850 Series protocol:**  
**HMI Setting**

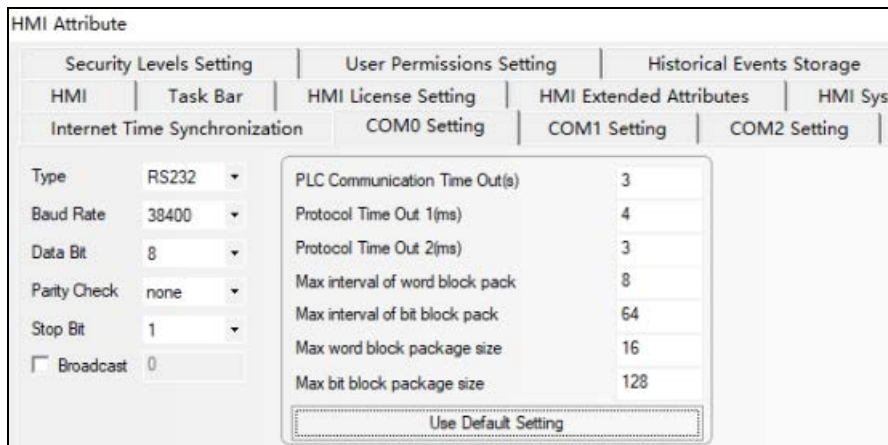

**PLC Setting**

CCW software set as follows:

1. Set the serial port

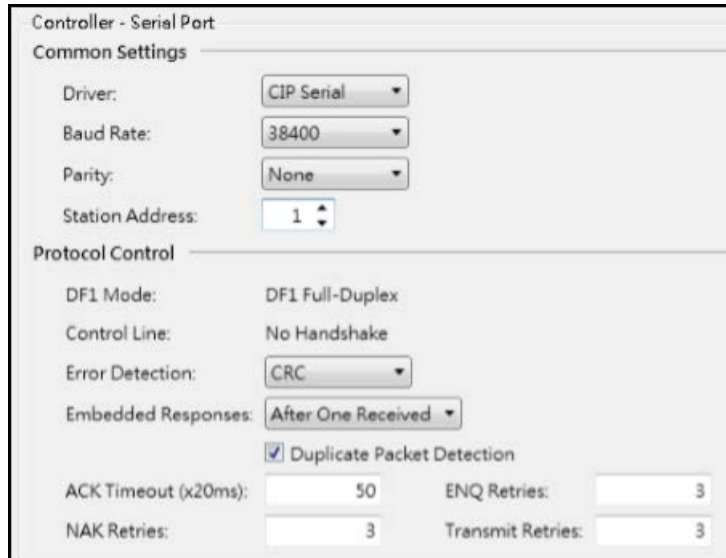

2.Add some global tags

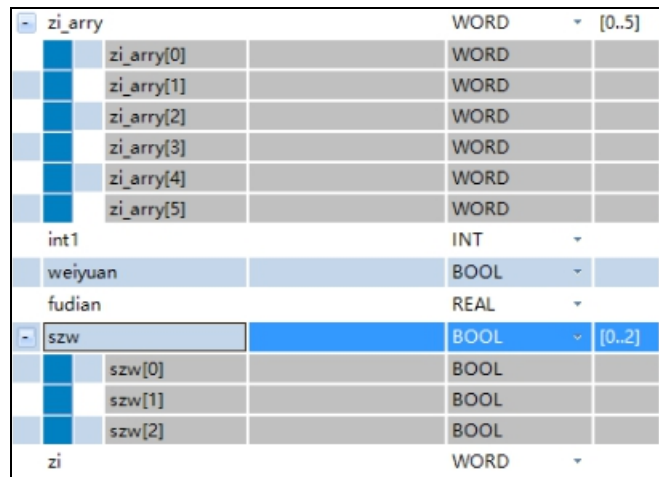

3.Select them and right click to copy.

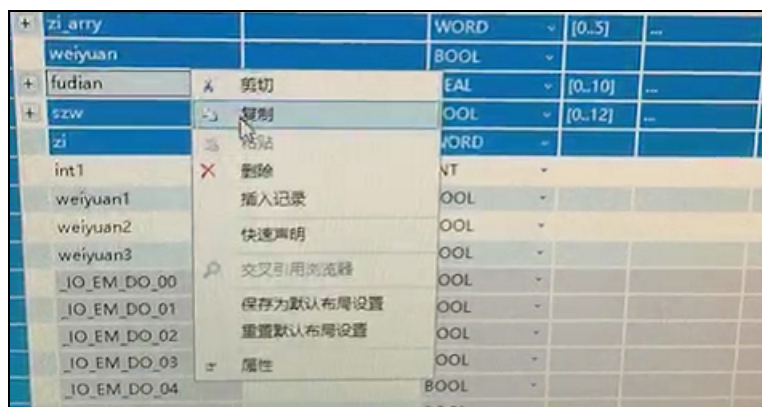

4.Open the PLC address tag editor in HMI software

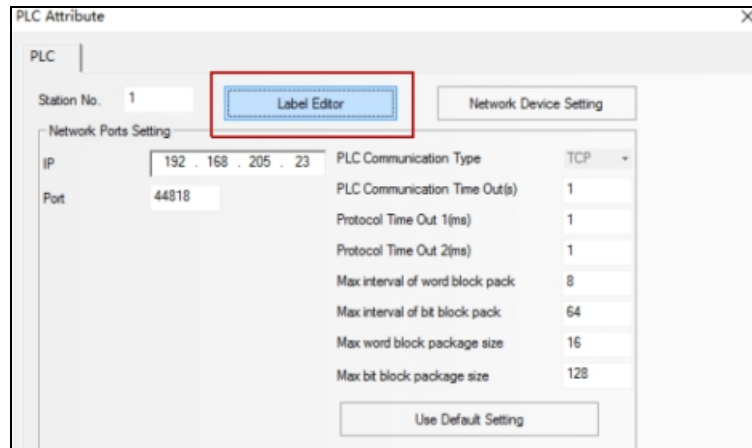

Click paste

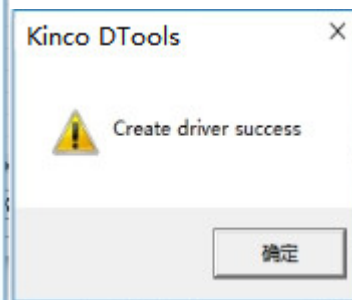
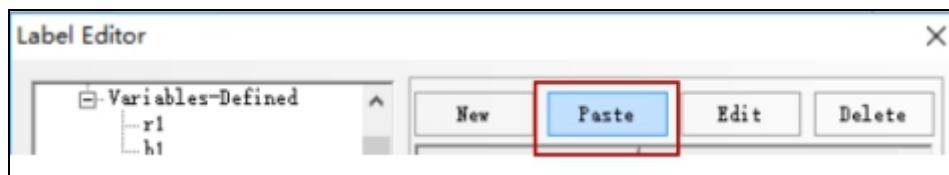

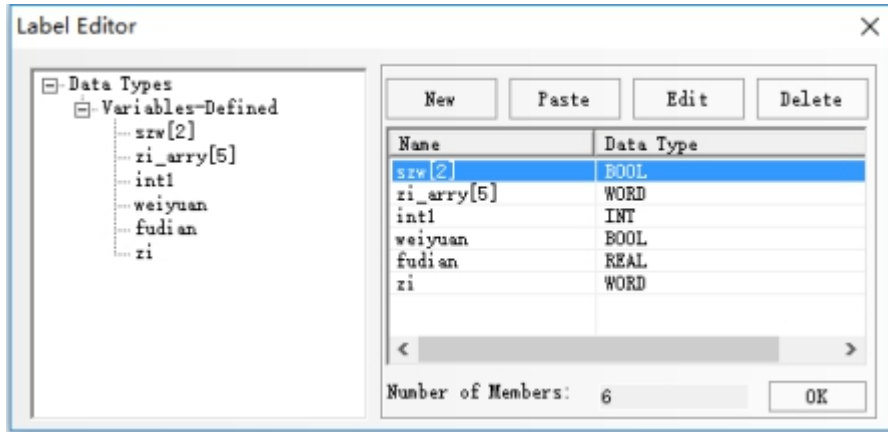

5. You can also click "New" to add a new register corresponding to your PLC

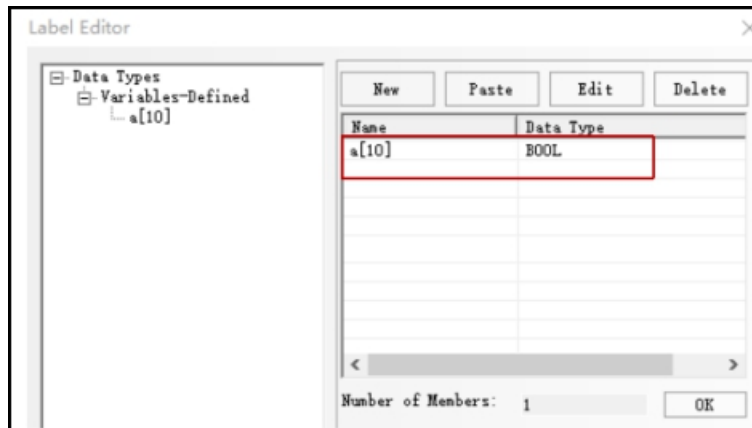
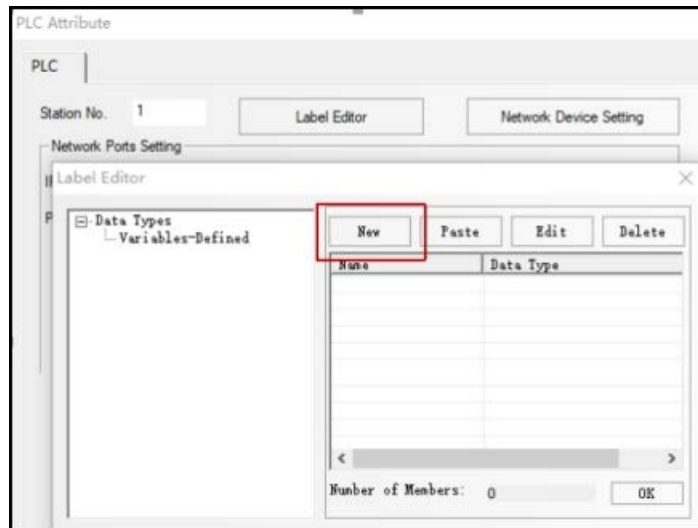

Note: When Kinco DTools V3.4 or higher version open kinco HMIware2.5 or lower than Kinco DToolsV3.4 's project, you must open the label editor and click OK (regenerate the label), as shown in the figure:



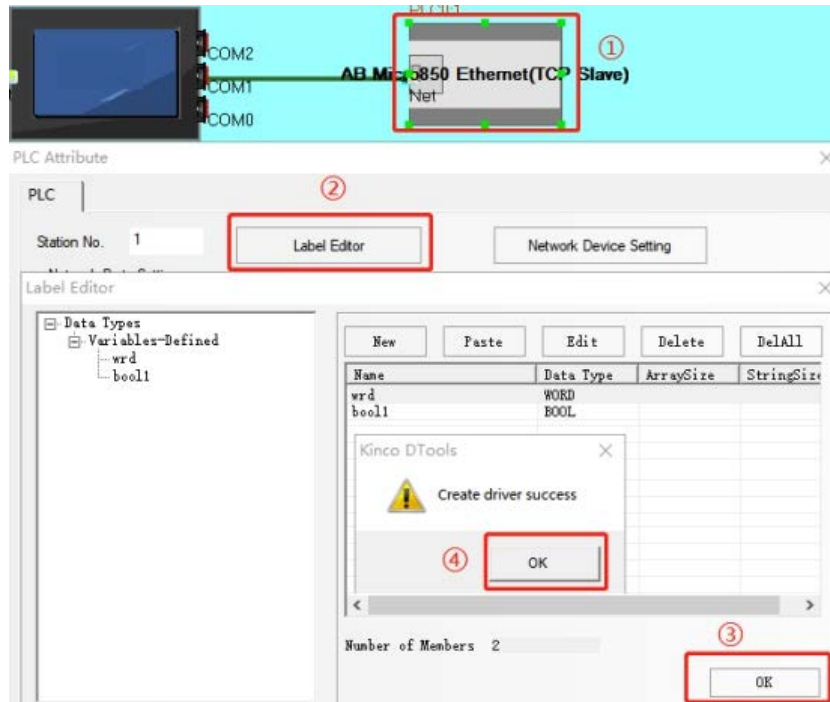

## ◎ Ethernet Communication Setting

AB SLC500/PLC5/MicroLogix Series Ethernet(TCP Slave) protocol

HMI Setting

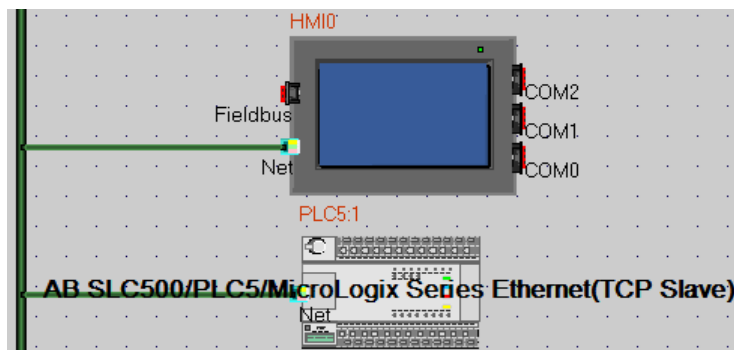

Device	IP Addr	Port	Protocol	Master/...	State
HMI0	192.168.100.220	44818	AB SLC500/PLC5/MicroLogix Ser...	M	
PLC0	192.168.100.230	44818	AB SLC500/PLC5/MicroLogix Ser...	S	1

Buttons: Add, Delete, Delete All, Modify, OK

PLC Setting

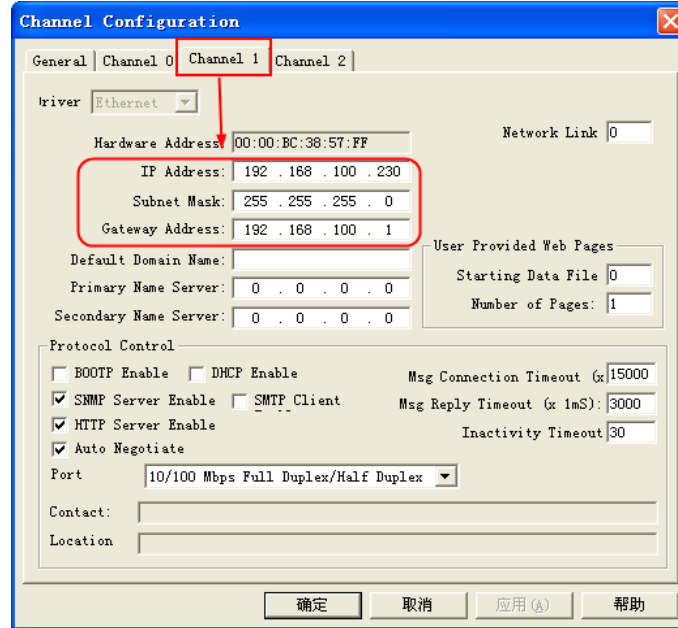

**AB CompactLogix/ControlLogix Series Ethernet(TCP Slave) protocol HMI Setting**

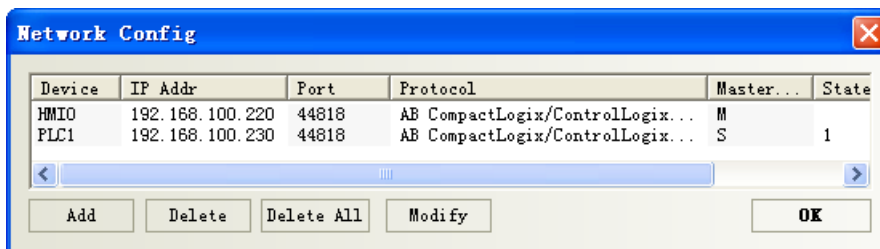
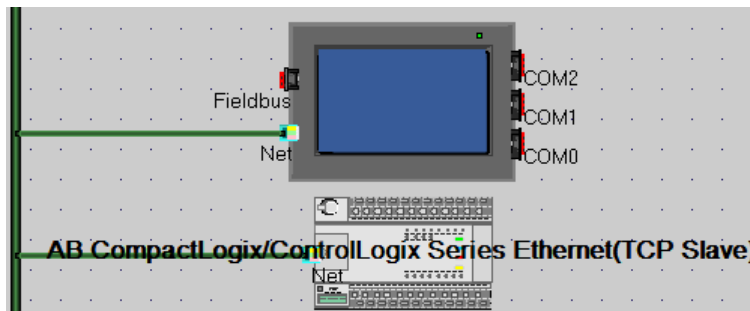

**PLC Setting**

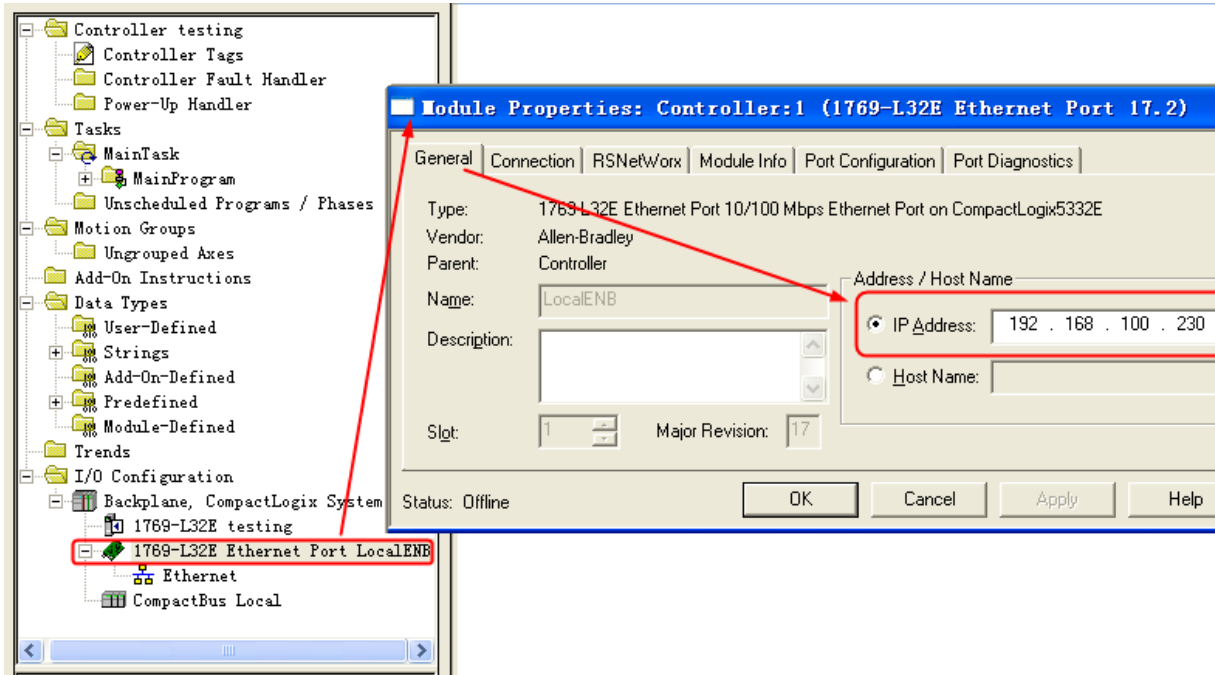

**AB CompactLogix/ControlLogix Series Ethernet (TCP Slave) (Free Tag Names) protocol:**  
**HMI setting**

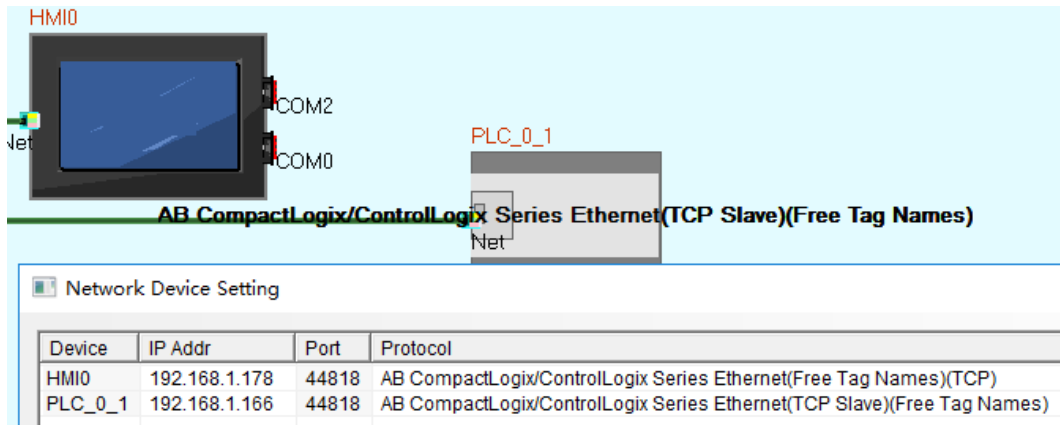

Double click PLC to import label

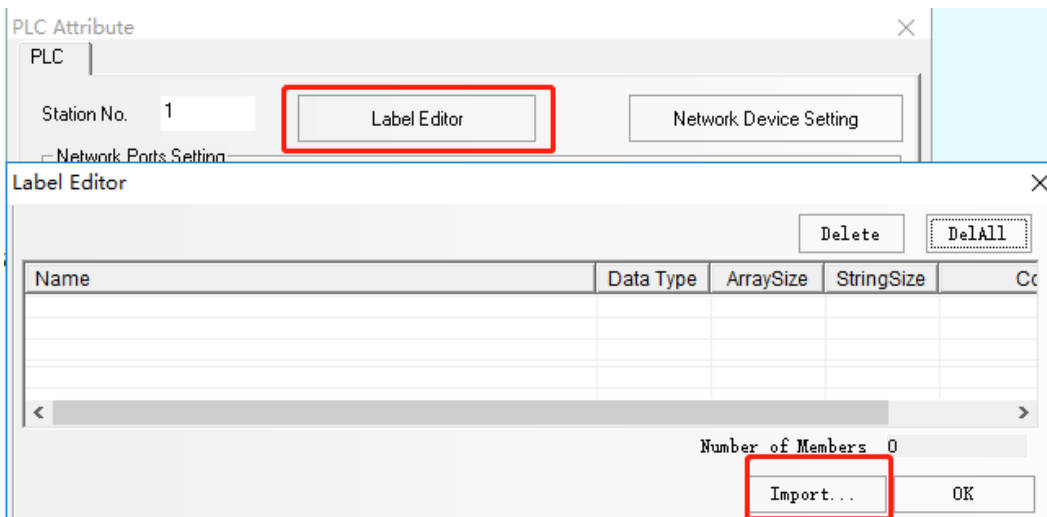

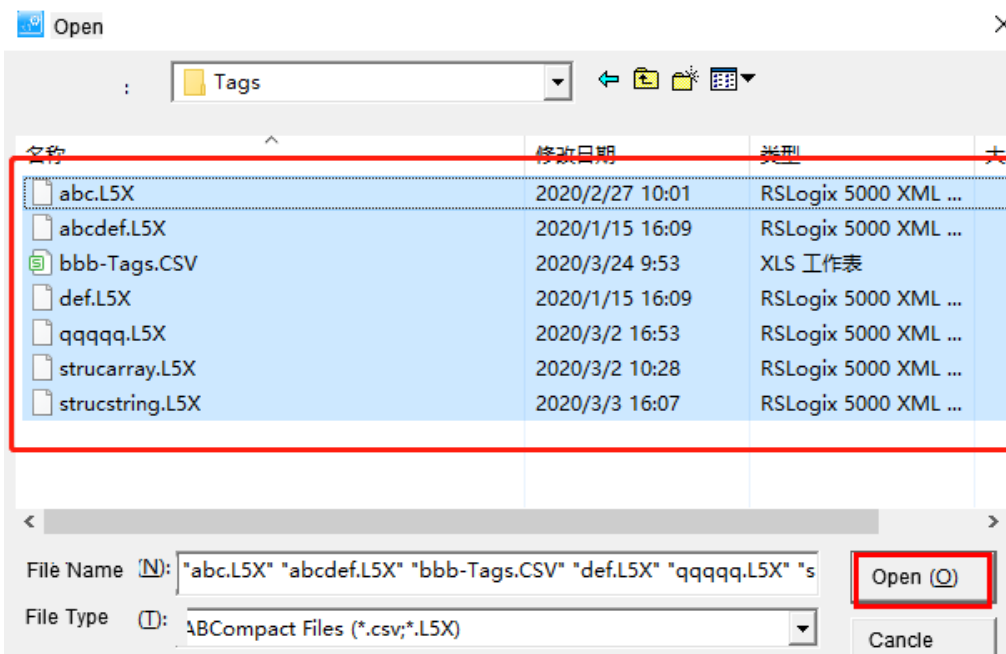
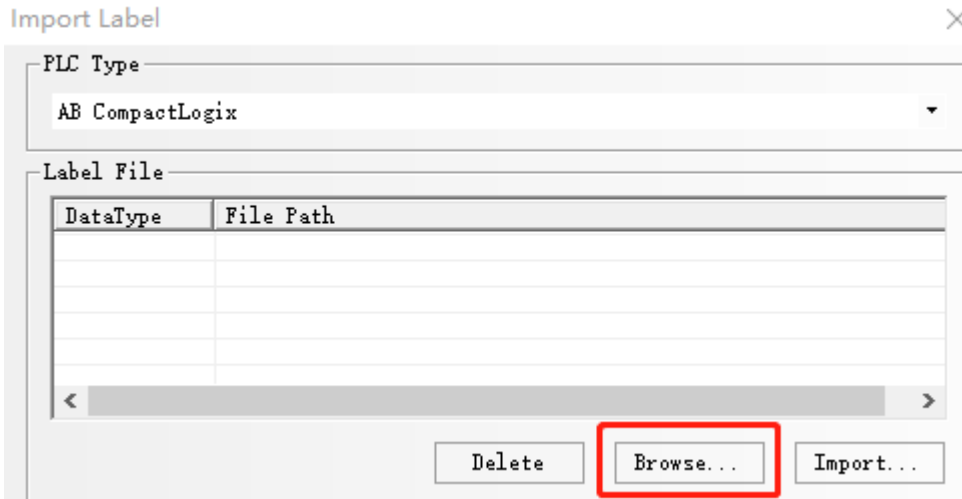

Batch import label CSV and L5X label files exported by PLC software (2 files generated by PLC programming software: L5X is a structure type file, and CSV is a label file)

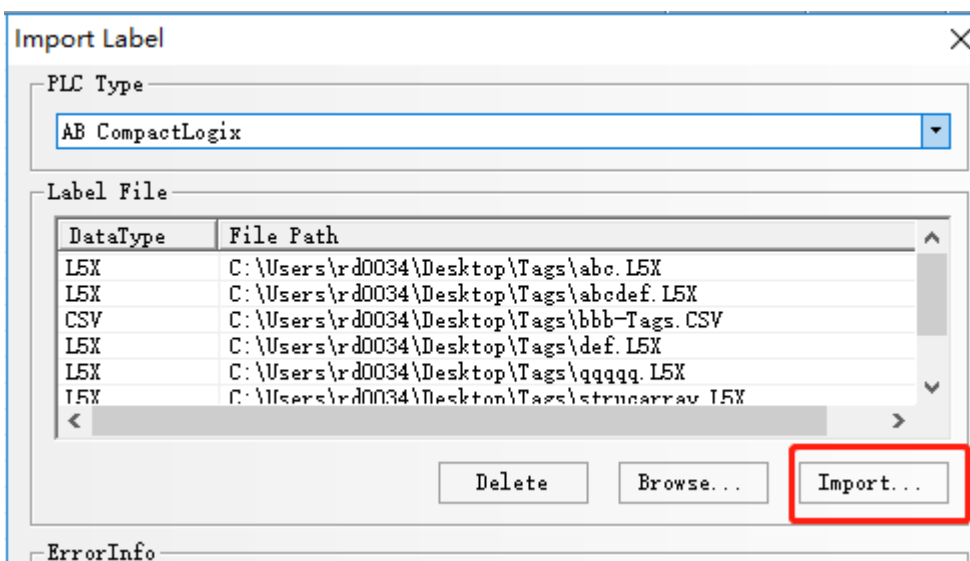

## PLC Setting

RSLogix5000Software settings :

Lable setting : Controller Tags

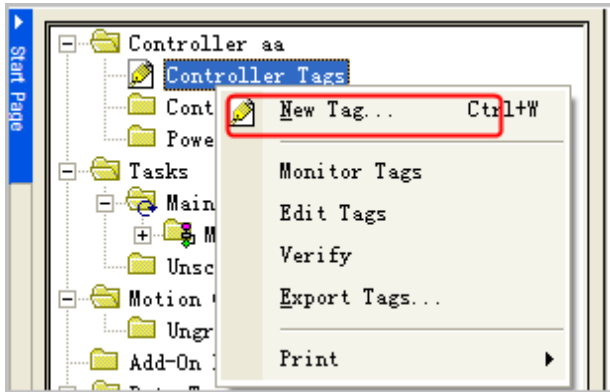

### 1. Common label

Create a new tag directly in the tag editor. This only needs to export the CSV to communicate directly with the screen.

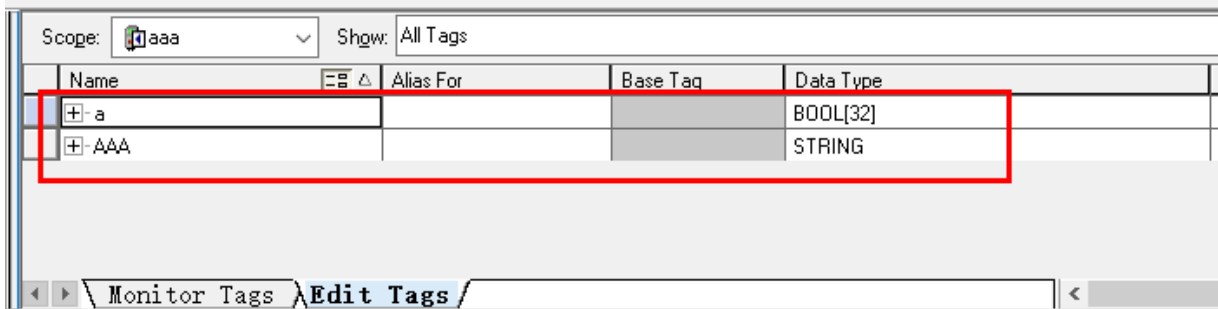

### 2. User-Defined label (Structure tag)

As shown: Structure type "abc":After creating the data type"abc", you need to add a tag in the tag editor and reference the type. For example, add a new tag named "strucabc" to reference the structure type" abc".

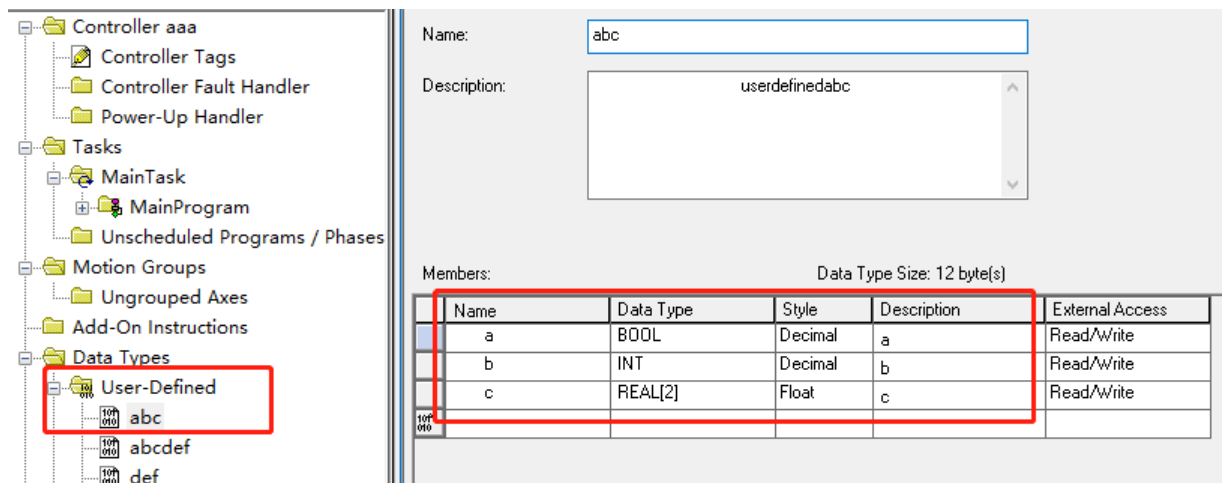

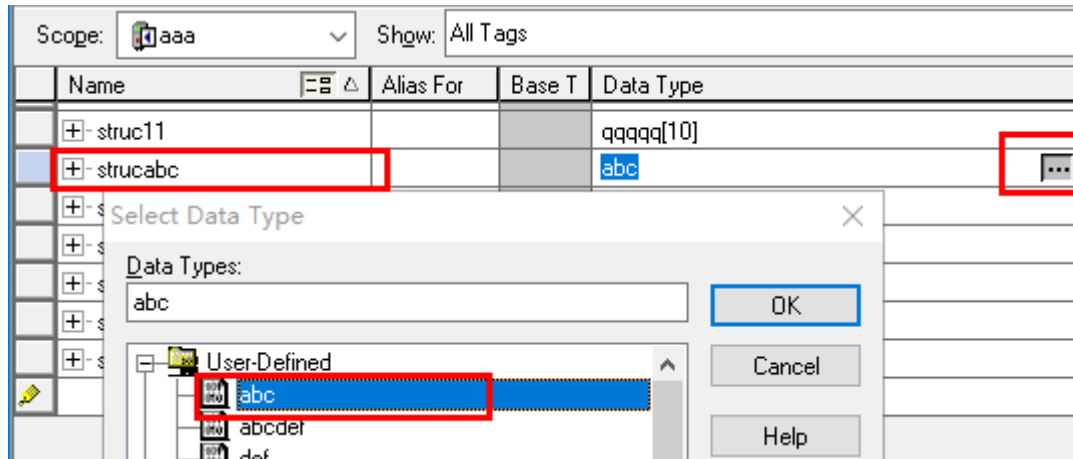

strucabc		abc	userdefinedabc	R
strucabc.a		BOOL	userdefinedabc a	F
strucabc.b		INT	userdefinedabc b	F
strucabc.c		REAL[2]	userdefinedabc c	F
strucabcdef		abcdef		D

For this type of structure type label, you need to import not only the label CSV to the project of the screen, but also the structure L5X file:

Rightclick "abc" to export data type

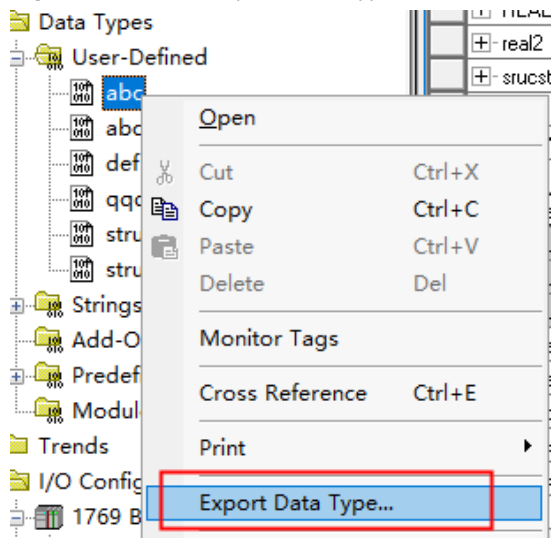

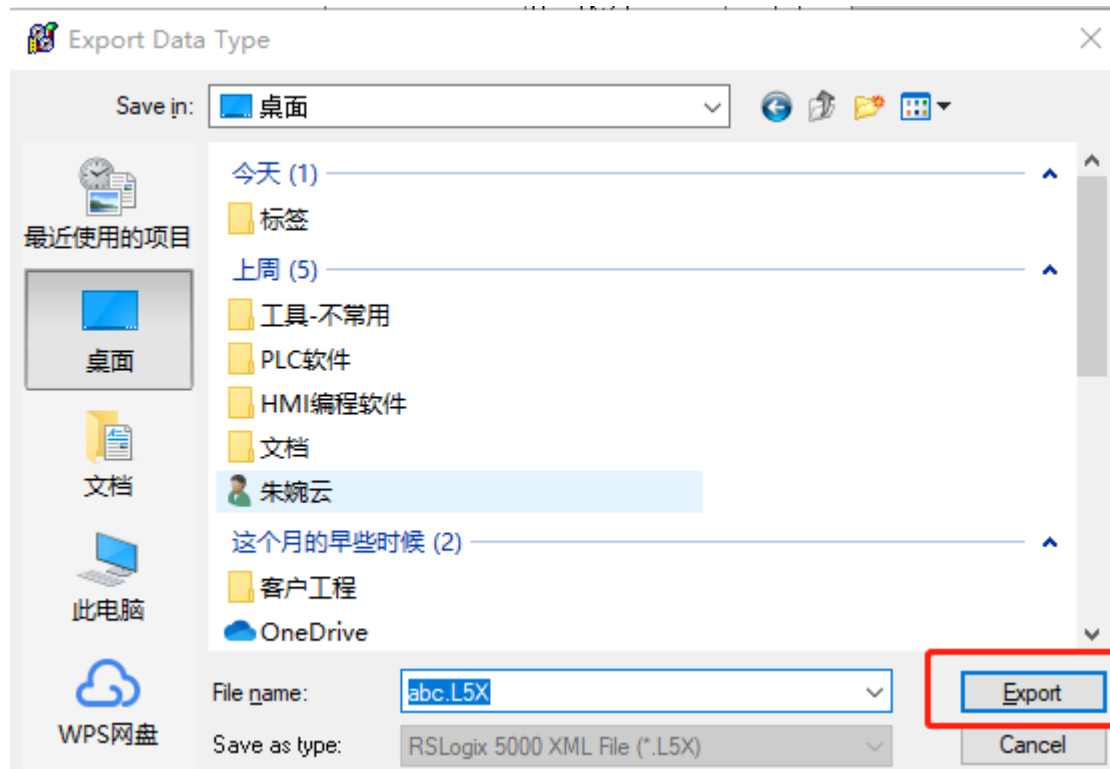

After editing all tags, click Tools-export-tags and logic comments to export the tags CSV file

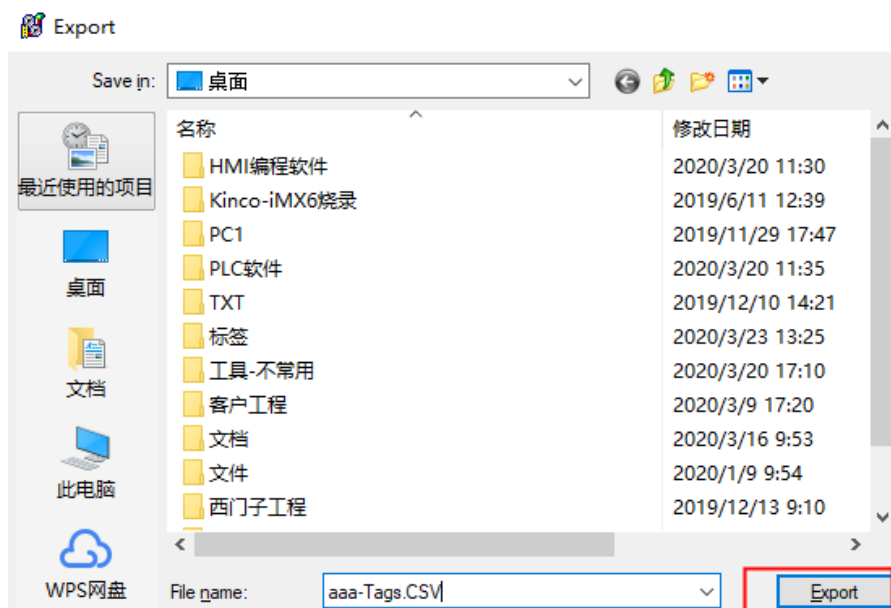
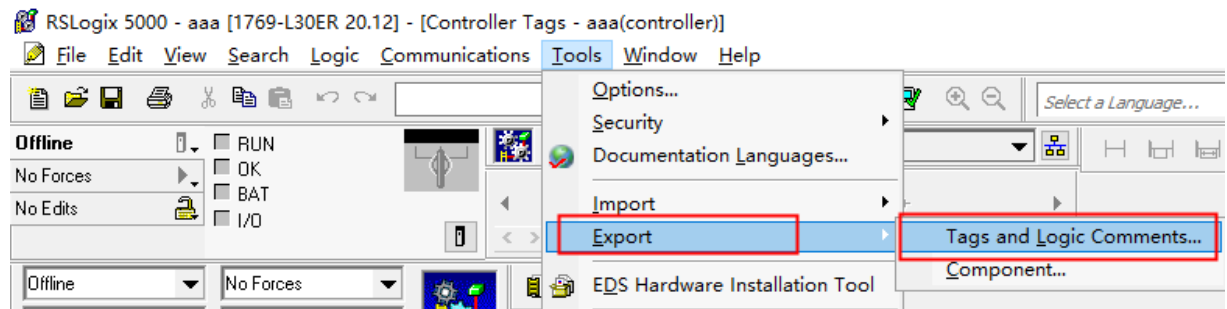

## AB Micro850 Ethernet (TCP Slave) protocol

### HMI setting

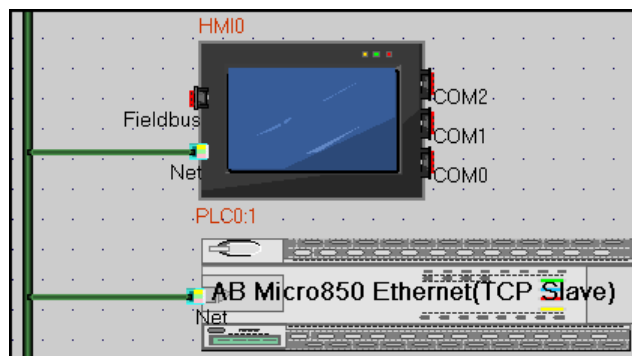

Device	IP Addr	Port	Protocol	Master/...	Stati...	Virtual...
HMI0	192.168.205.110	44818	AB Micr...	M		
PLC0	192.168.205.23	44818	AB Micr...	S	1	

### PLC Setting

1. Set the IP address of PLC, consistent with the configuration in HMI software.

Controller - Ethernet

**Ethernet Settings**

**Internet Protocol (IP) Settings**

Obtain IP address automatically using DHCP

Configure IP address and settings

IP Address:

Subnet Mask:

Gateway Address:

Detect duplicate IP address

**Port Settings**

Port State:  Enabled  Disabled

Auto-Negotiate Speed and Duplex Mode

2. Setting the required types and addresses of registers in your PLC software, such as below:

zi\_arry : An array of bool elements with a dimension of 6

Int1: int type

weiyuan: bool type

fudian: float\real type

szw: An array of word elements with a dimension of 3

zi: word type



zi_array		WORD	[0..5]
zi_array[0]		WORD	
zi_array[1]		WORD	
zi_array[2]		WORD	
zi_array[3]		WORD	
zi_array[4]		WORD	
zi_array[5]		WORD	
int1		INT	
weiyuan		BOOL	
fudian		REAL	
szw		BOOL	[0..2]
szw[0]		BOOL	
szw[1]		BOOL	
szw[2]		BOOL	
zi		WORD	

3. Select the established variables and copy them.

4. Open the PLC address tag editor in HMI software:

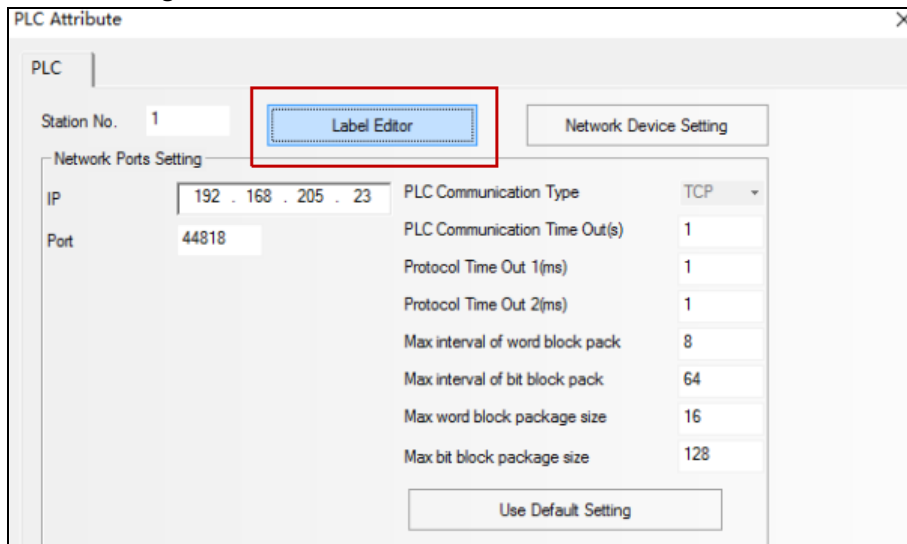

5. Right click to add data type

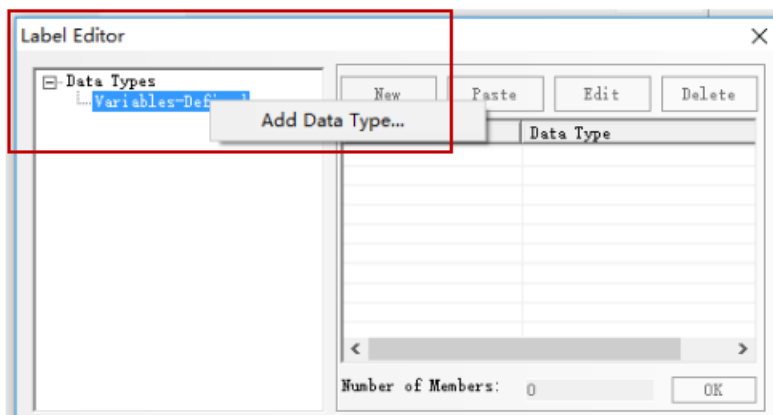

6. Click paste

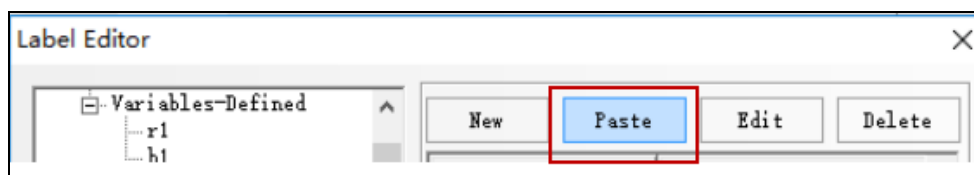

## 7. Start paste, and click" OK"

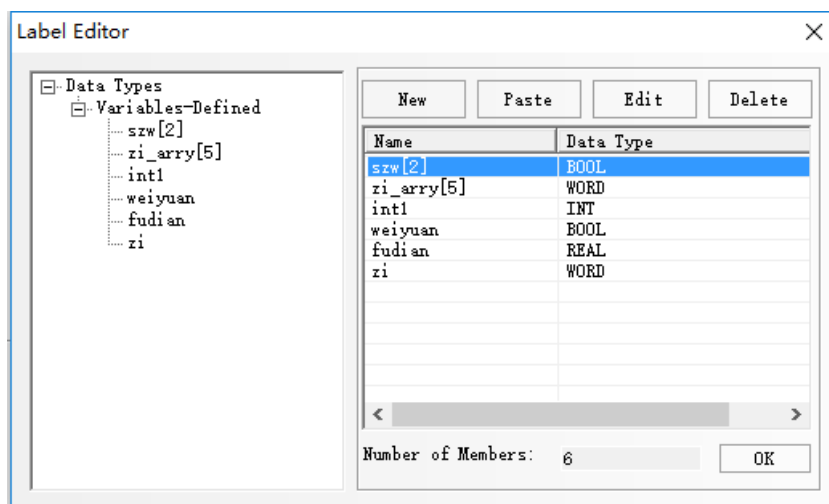
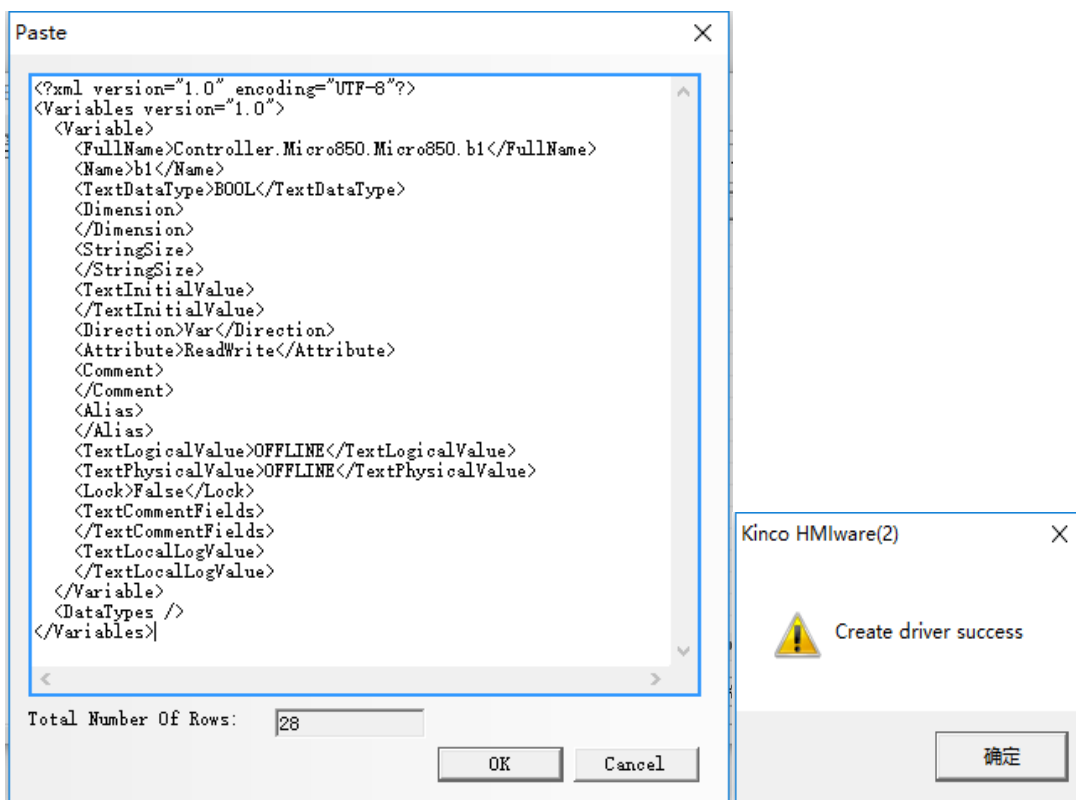

8.You can also click "New"to add a new register corresponding to your PLC,and be sure to double click when you chose the data type ,or it will prompt "error:data type doesn't exist!"

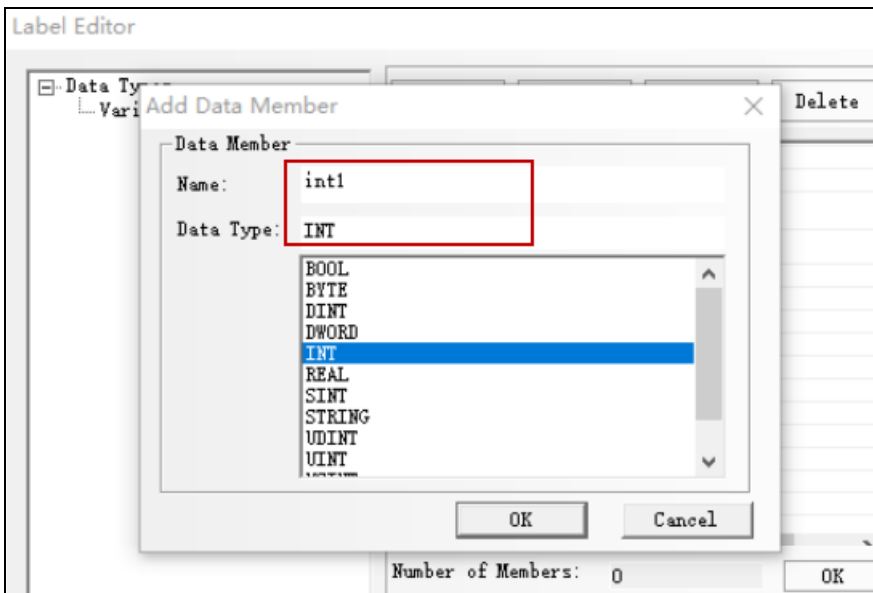
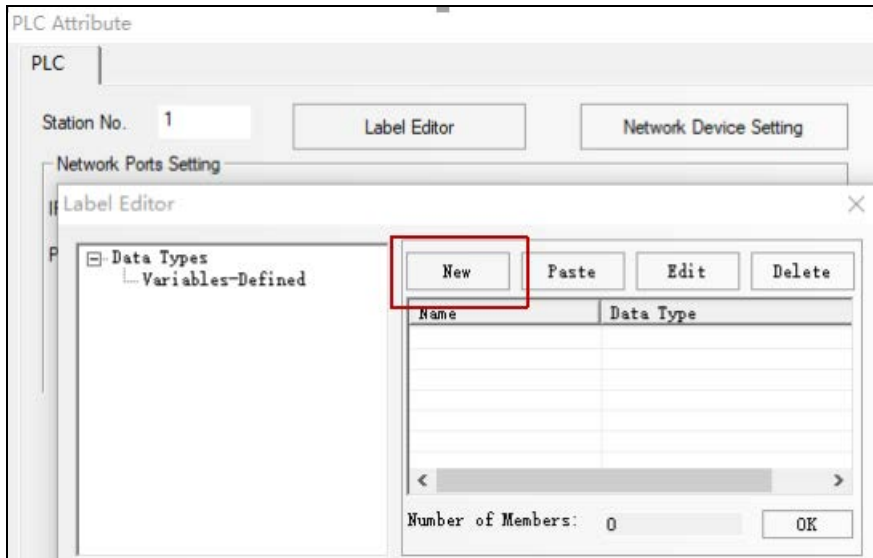

9. Add array:

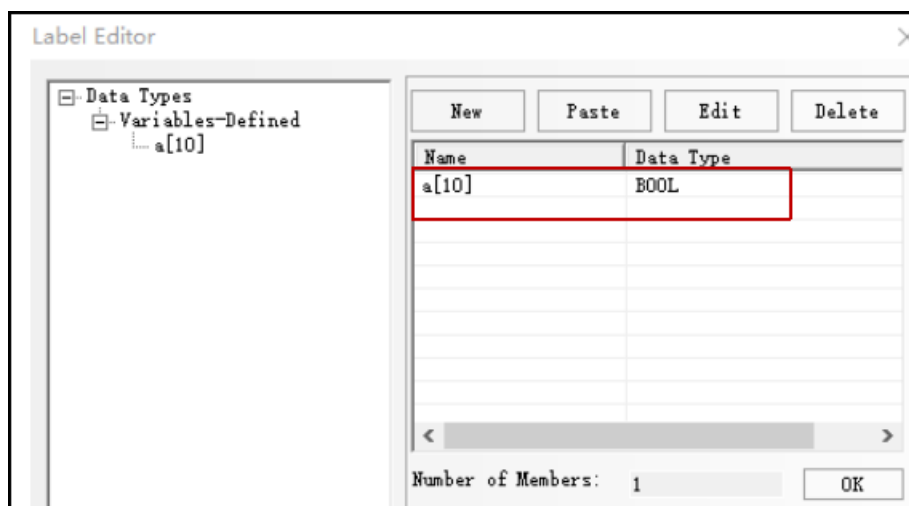
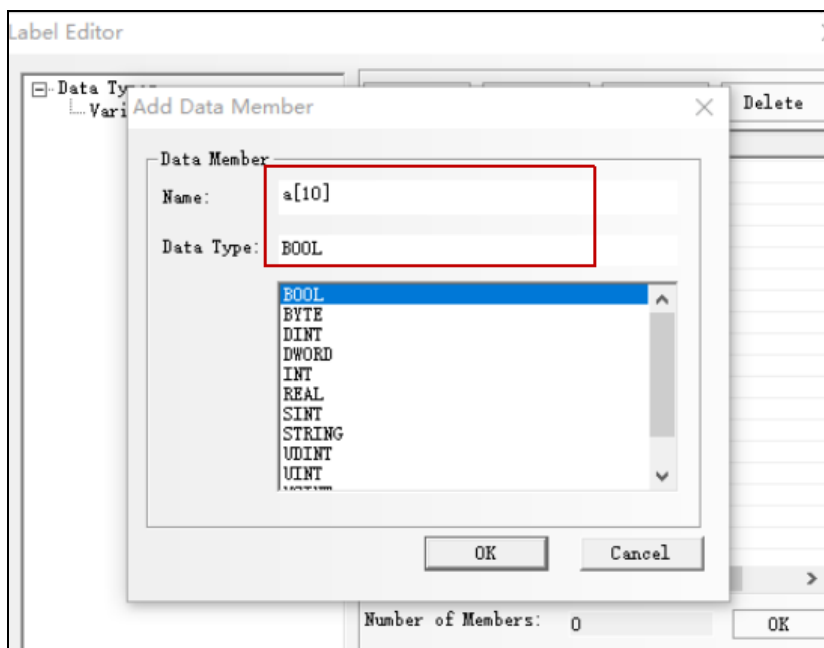

10. After setting up the variables, you can set the corresponding components in the configuration.

### ©Supported Register

#### AB SLC500/PLC5/MicroLogix Series(DF1)

Device	Bit Address	Word Address	Format	Notes
Bit data file	B3: 0.0-255.15	-----	DDD.DD	
Bit data file	B10: 0.0-255.15	-----	DDD.DD	
Bit data file	B11: 0.0-255.15	-----	DDD.DD	
Bit data file	B12: 0.0-255.15	-----	DDD.DD	
Bit data file	B13: 0.0-255.15	-----	DDD.DD	
Bit data file	Bf:n: 0.0-255.255.15	-----	DDDDDD.DD	*1
Output data file	O0: 0.0-255.15	-----	DD.DD	
Input data file	I1: 0.0-255.15	-----	DD.DD	
Integer data file	-----	N15: 0-255	DDD	
Integer data file	-----	N14: 0-255	DDD	

Integer data file	-----	N13: 0-255	DDD	
Integer data file	-----	N12: 0-255	DDD	
Integer data file	-----	N11: 0-255	DDD	
Integer data file	-----	N10: 0-255	DDD	
Integer data file	-----	N7: 0-255	DDD	
Integer data file	-----	Nf:n: 0-255255	DDDDDD	*1
Floating point data file	-----	F8: 0-255	DDD	
Counter Accumulator Value	-----	C5PV: 0-255	DDD	
Counter Preset Value	-----	C5SV: 0-255	DDD	
Timer Accumulator Value	-----	T4PV: 0-255	DDD	
Timer Preset Value	-----	T4SV: 0-255	DDD	

**Note:**

The format of I/O address is I/O e.s/b, and the e is slot number, s is variable number and b is bit number.

**For example:**

The PLC address is **00 0.0/11**, mapping address in HMI is **00 0.11**;

The PLC address is **00 0.1/8**, mapping address in HMI is **00 1.8**.

The I/O address in HMI is continuous when different AB CPU use the I/O modules.

Take Micrologix 1400 + output module 1762-OW16 for example, **00 1.3/3** maps the **00 6.3** in HMI.

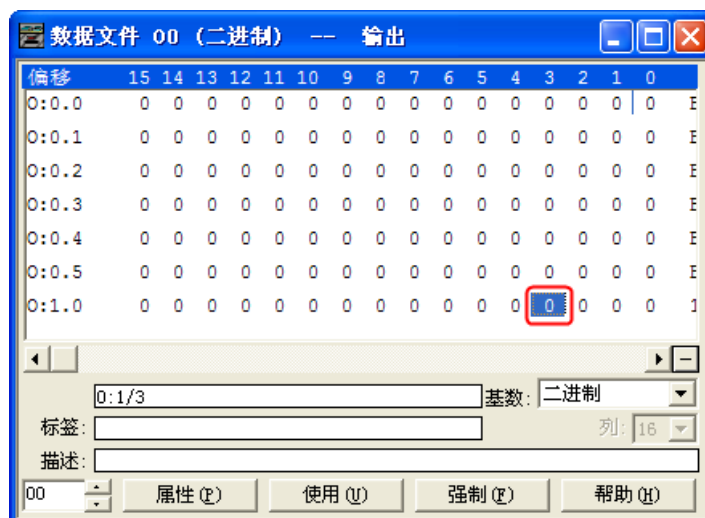
**Note:**

\*1 Variable less than three address the need to fill the former 0

The correct format example as follow:

**Bf:n 113087.12**, file number is 113, variable address is 87.12, and mapping address in PLC is **B113: 87/12**;

**Nf:n 9002**, file number 9, variable address 2, and mapping address in PLC is **F9:2**.

**AB CompactLogix/ControlLogix Series(DF1)**

Device	Bit Address	Word Address	Format
Integer data file bit level	N_BOOL000000.00~254254.15	-----	DDDDDD.DD*1
Bit data file	B_BOOL000000~254991	-----	DDDDDD*1
Floating point data file	-----	REAL000000~254254	DDDDDD*1

Integer data file	-----	INT000000~254254	DDDDDD*1
DInteger data file	-----	DINT000000~254254	DDDDDD*1

**Note:**

\*1 Variable less than three address the need to fill the former 0

The correct format example as follow: file number is 112, variable address is 87.12, format is **112087.12**.

2. Users can define the File Number.

**AB SLC500/PLC5/MicroLogix Series Ethernet(TCP Slave)**

Device	Bit Address	Word Address	Format	Notes
Bit data file	B13: 0.0-255.15	-----	DDD.DD	
Bit data file	B12: 0.0-255.15	-----	DDD.DD	
Bit data file	B11: 0.0-255.15	-----	DDD.DD	
Bit data file	B10: 0.0-255.15	-----	DDD.DD	
Bit data file	B3: 0.0-255.15	-----	DDD.DD	
Bit data file	Bf:n: 0.0-255255.15	-----	DDDDDD.DD	*1
Output bit data file	O0: 0.0-255.15	-----	DD.DD	
Input bit data file	I1: 0.0-255.15	-----	DD.DD	
Output data file	-----	OW0: 0-255	DDD	
Input data file	-----	IW1: 0-255	DDD	
Integer data file	-----	N15: 0-255	DDD	
Integer data file	-----	N14: 0-255	DDD	
Integer data file	-----	N13: 0-255	DDD	
Integer data file	-----	N12: 0-255	DDD	
Integer data file	-----	N11: 0-255	DDD	
Integer data file	-----	N10: 0-255	DDD	
Integer data file	-----	N7: 0-255	DDD	
Integer data file	-----	Nf:n: 0-255255	DDDDDD	*1
Floating point data file	-----	F8: 0-255	DDD	
Floating point data file	-----	Ff:n: 0-255255	DDDDDD	*1
Counter Accumulator Value	-----	C5PV: 0-255	DDD	
Counter Preset Value	-----	C5SV: 0-255	DDD	
Timer Accumulator Value	-----	T4PV: 0-255	DDD	
Timer Preset Value	-----	T4SV: 0-255	DDD	

**Note:**

\*1 Variable less than three address the need to fill the former 0

The correct format example as follow:

**Bf:n 113087.12**, file number is 113, variable address is 87.12, and mapping address in PLC is **B113: 87/12**;

**Ff:n 9002**, file number 9, variable address 2, and mapping address in PLC is **F9:2**.

**AB CompactLogix/ControlLogix Series Ethernet(TCP Slave)**

Device	Bit Address	Word Address	Format
Integer data file bit level	N_BOOL000000.00~254255.15	-----	DDDDDD.DD*1

Bit data file	B_BOOL000000~254999	-----	DDDDDD*1
Floating point data file	-----	REAL000000~254255	DDDDDD*1
Integer data file	-----	INT000000~254255	DDDDDD*1
DInteger data file	-----	DINT000000~254255	DDDDDD*1

**NOTE:**

1. Variable less than three address the need to fill the former 0

The correct format example as follow: file number is 112, variable address is 87.12, format is **112087.12**.

3. Users can define the File Number.

**AB CompactLogix/ControlLogix Series Ethernet (TCP Slave) (Free Tag Names)****&AB CompactLogix\_ControlLogix (Free tag Names)**

Device	Type	Address	Format
Bit	BOOL	-	D
SINT	SINT	-	D
INT	INT	-	D
DINT	DINT	-	D
REAL	REAL	-	D
STRING	STRING	-	D

**AB Micro850 Series \Ethernet (TCP Slave)**

Device	Type	Address	Format
Bit Register	BOOL	-	D
Byte Register	BYTE	-	D
SINT	SINT	-	D
USINT	SINT	-	D
WORD	WORD	-	D
INT	INT	-	D
Unsigned INT	UINT	-	D
Double Word	DWORD	-	D
Double INT	DINT	-	D
Float	REAL	-	D
Unsigned Double INT	UDINT	-	D
String	STRING	-	D

**© Cable Diagram****MicroLogix \AB800 RS232 cable diagram**

1. Cable made by AB Corporation

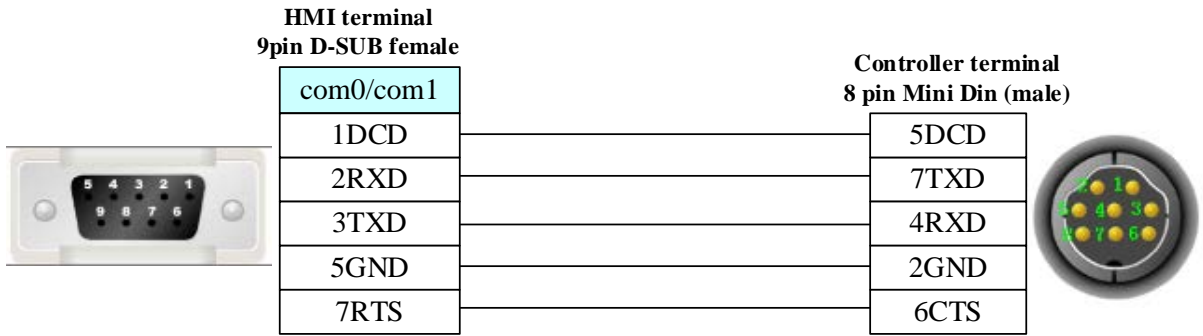

2. Communication module AIC+ (Part No. 1761-NET-AIC) RS232

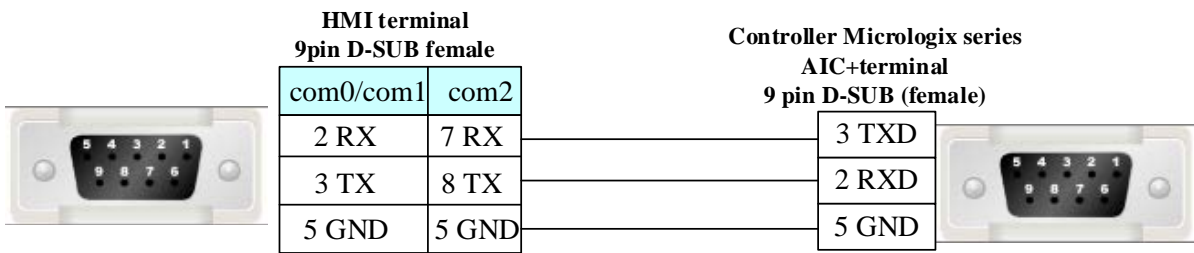

SLC 5/03 RS232 cable diagram

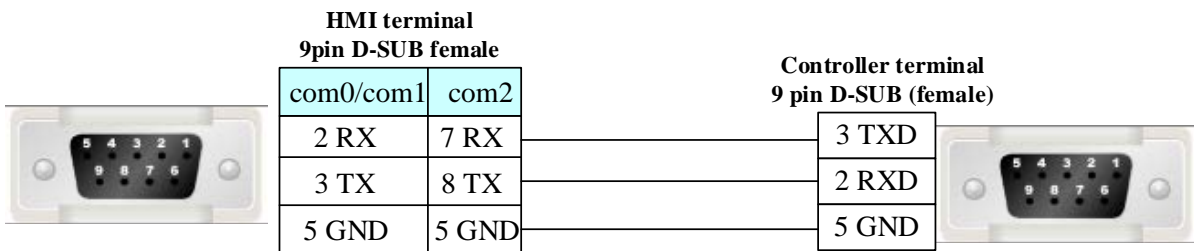

PLC-5 RS232 cable diagram

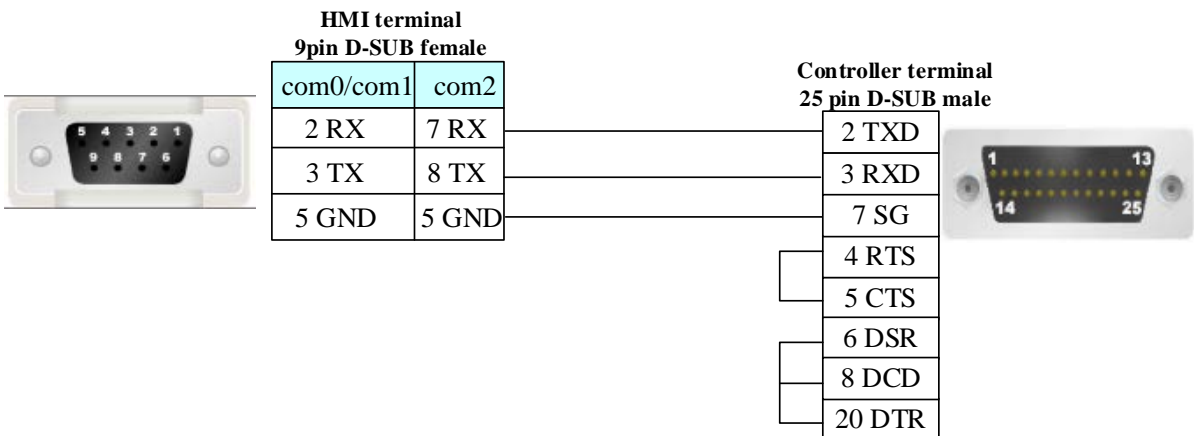

CompactLogix/ ControlLogix RS232 cable diagram



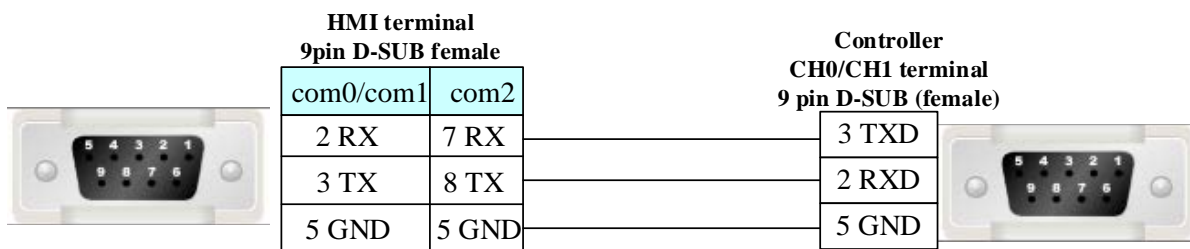

### Ethernet cable

Connecting PC and HMI use cross-ruling; communicating with hub or switch use cross-over cable or cross-ruling.

Refer to [3.3 Download by Network Ethernet](#) for method of making connection cable.

## 4.3 ACS-Tech80 Motion Controller

### Serial Communication

Series	CPU	Link Module	Driver
SA2103	SB214SA	RS232 on the CPU unit	ACS-Tech80

### System configuration

Series	CPU	Link Module	COM Type	Parameter	Cable
SA2103	SB214SA	RS232 on the CPU unit	RS232	<a href="#">Setting</a>	<a href="#">Your owner cable</a>

### Communication Setting

#### RS232 communication

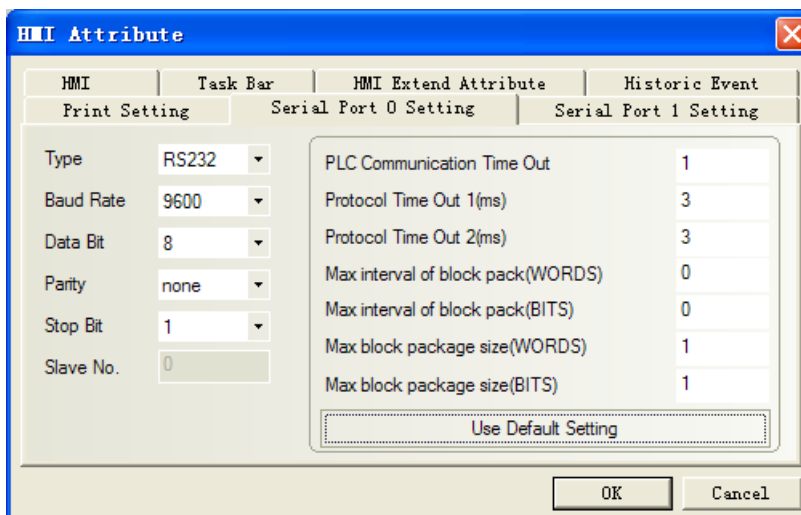

### Supported Device

Device	Bit Address	Word Address	Format	Notes
Linear Deceleration (LD)	-----	LD 0~3	D	R/W

Linear Acceleration(LA)	-----	LA 0~3	D	R/W
Linear Velocity(LV)	-----	LV 0~3	D	R/W
Next trgt Abs Pos(AP)	-----	AP 0~3	D	R/W
Next Motion Mode(MM)	-----	MM 0~3	D	R/W
Functions Avail.(FA.1)	-----	FA.1 0~3	D	Read Only
Array Offset(AO)	-----	AO 0~3	D	R/W
Array's Upper Index(UI)	-----	UI 0~3	D	R/W
Array's Low Index(LI)	-----	LI 0~3	D	R/W
Path Gen.mode(PG)	-----	PG 0~3	D	R/W
Motor enabled(MO)	MO 0~3	-----	D	Write Only
CLEAR	CLEAR 0	-----	D	Write Only
RESET	RESET 0	-----	D	
B	B 0~3	-----	D	

**Note:** R: Readable, W: Writable.

### Register instructions:

- LD、LA、LV、AP、MM、FA.1、AO、UI、LI、PG  
Main address: Axis parameter number (X、Y、Z、T)
- MO、B (Operating instructions)  
Main address: Axis parameter number (X、Y、Z、T)
- CLEAR、RESET (Operating instructions)

## ◎ Cable Diagram

### RS232 communication cable

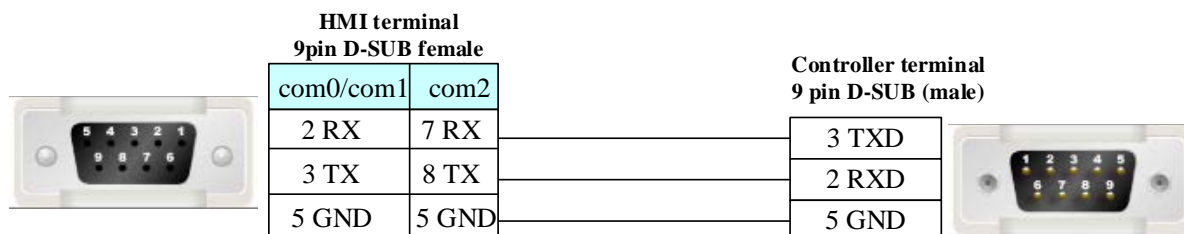

## 4.4 ADAM

### ◎ Serial Communication

Series	CPU	Link Module	Driver
ADAM	ADAM-4017	RS485 on the CPU unit	ADAM-4017
	ADMA-4015	RS485 on the CPU unit	ADMA-4015

### ◎ System configuration

Series	CPU	Link Module	COMM Type	Parameter	Cable
--------	-----	-------------	-----------	-----------	-------

ADAM	ADAM-4017	RS485on the CPU unit	RS485	<a href="#">Setting</a>	<a href="#">Your owner cable</a>
	ADMA-4015	RS485 on the CPU unit	RS485	<a href="#">Setting</a>	<a href="#">Your owner cable</a>

## ◎ Communication Setting

### HMI Setting

**ADAM-4017** default communication: 9600, 8, none, 1; station: 255

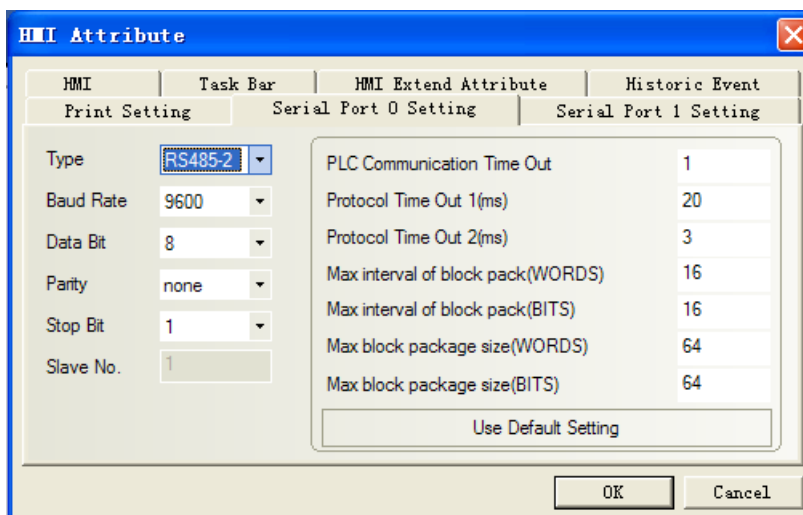

- Note:**
- a. To allow the “Check Code”;
  - b. Direct online simulation disables.

**ADAM-4015** default communication: 9600, 8, none, 1; station: 1

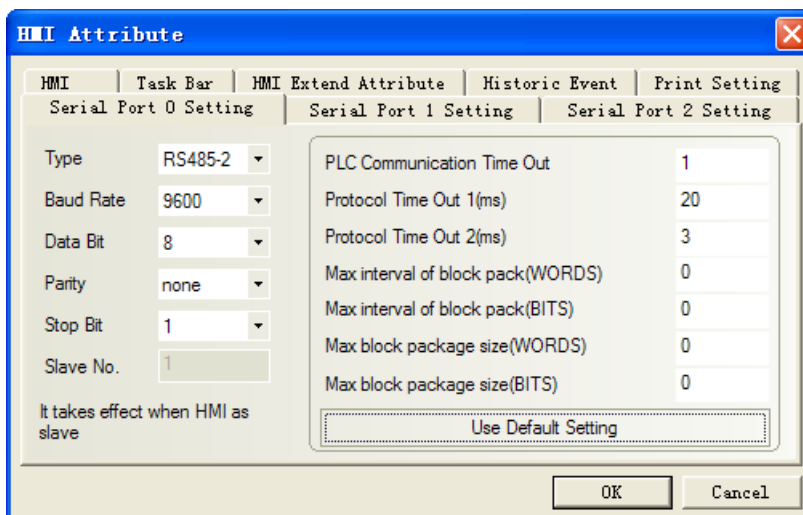

**Note:** PLC station must match with the ADAM-4015 configuration.

### PLC Setting

Connect “INIT” with “GND”, and reset the device, then set the communication of ADMA-4015.

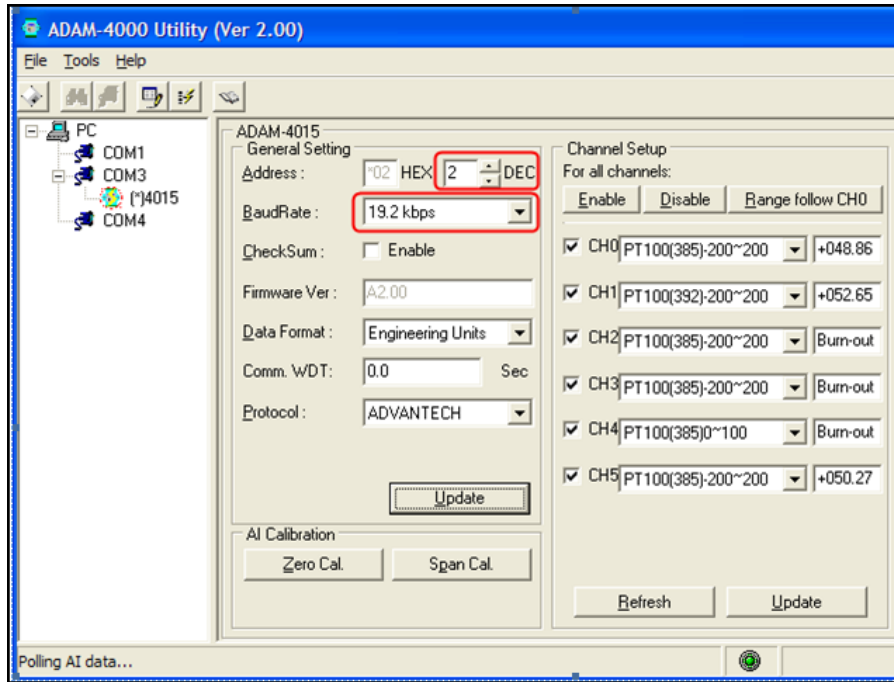

Set OK, then Update.

## ◎ Supported Device

### ADAM-4017

Device	Bit Address	Word Address	Format
Read Analog Input form Channel N	-----	S_Channel 0-65535	DDDDD
Read Analog Input from all Channel	-----	A_Channel 0-7	D
Configuration Status	-----	Status 0-65535	DDDDD
Enable/disable Channels for Multiplexing	-----	M_channel 0-65535	DDDDD
Read Channel Status	-----	Channel_Status 0-65535	DDDDD
Read Version	-----	Version 0-65535	DDDDD
Read Module Name	-----	Name 0-65535	DDDDD

**Note:** Order code refer to the ADAM-4107 manual

- 1、“Data type” of S\_Channel and A\_Channel is signed integer. Decimal digits is 2 when the power supply is 500mv or 150mv, other conditions is 3.
- 2、“Data type” of other registers is HEXING
- 3、M\_channel ( \$AA5VV ) : At the same time allow multiplexing.  
Enter the decimal value in the range of 0 to 255, mapping hexadecimal (00-FF)

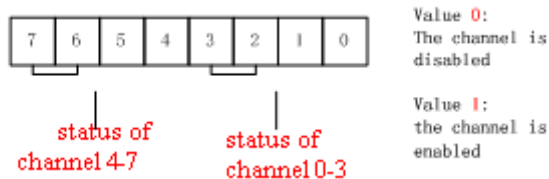

255 ( FF ) : 0-7 channel show.

127 ( 7F ) : 0-6 channel show, 7 Channel does not show.

### ADAM-4015

Device	Bit Address	Word Address	Format	Notes
Channel	-----	Channel 0-5	D	Floating

**Note:** Channel 0-5 data type is floating.

### ◎ Cable Diagram

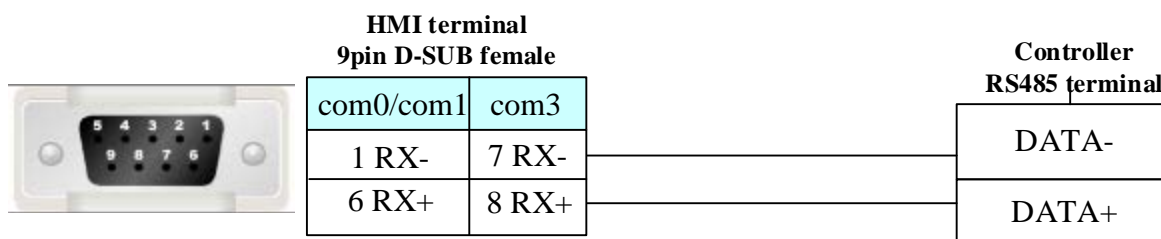

## 4.5 AysjNet

### ◎ Serial Communication

Series	CPU	Link Module	Driver
Compressor Controller	KYK3-K	RS485 on port	AysjNet

### ◎ System configuration

Series	CPU	Link Module	COMM Type	Parameter	Cable
Compressor Controller	KYK3-K	RS485 on port	RS485	<a href="#">Setting</a>	<a href="#">Your owner cable</a>

### ◎ Communication Setting

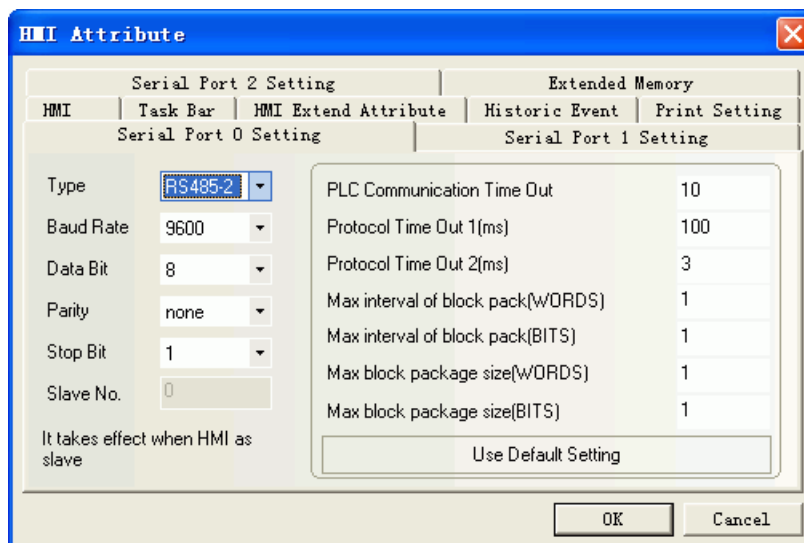

### ◎ Supported Device

Device	Bit Address	Word Address	Format	Notes
control	CTL (0~5) &128&150	-----	DDD	Write only
set	-----	SET (0~51)&128	DDD	
state	-----	STATUS 0.0~17.2	DD.D	Read only

◎ Cable Diagram

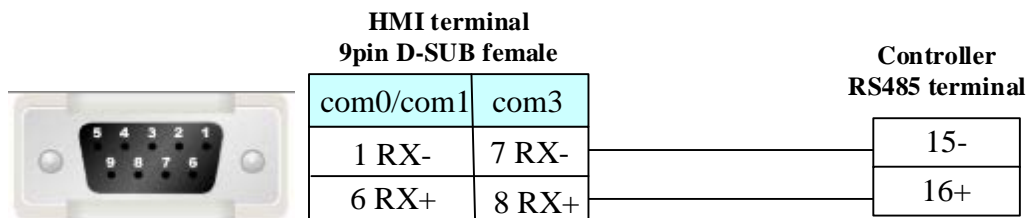

4.6 BACnet

◎ Serial Communication

Series	CPU	Link Module	Driver
BACnet MS/TP	VLC-660R Johnson FC BUS	Port on CPU unit	BACnet MS/TP
BACnet MS/TP Extend	ALERTON VLC-660R	Port on CPU unit	<b>BACnet MS/TP Extend</b>

◎ Ethernet Communication

Series	CPU	Link Module	Driver
BACnet IP		Ethernet interface on CPU	BACnet IP
BACnet IP Slave		Ethernet interface on CPU	BACnet IP Slave

◎ Serial System configuration

Series	CPU	Link Module	COM Type	Parameter	Cable
BACnet MS/TP	VLC-660R Johnson FC BUS	CPU Direct	RS485	<a href="#">Setting</a>	<a href="#">Your owner cable</a>
BACnet MS/TP Extend	ALERTON VLC-660R	Port on CPU unit	RS485	<a href="#">Setting</a>	<a href="#">Your owner cable</a>

◎ Ethernet System configuration

Series	CPU	Link Module	COMM Type	Parameter	Cable
BACnet IP		Ethernet interface on CPU	Ethernet	<a href="#">Setting</a>	<a href="#">Your owner</a>
BACnet IP Slave		Ethernet interface on CPU	Ethernet	<a href="#">Setting</a>	<a href="#">cable</a>

## ◎ Serial Communication Setting

### BACnet MS/TP protocol

#### HMI Setting

Default communication parameters 38400, 8, none, 1; station No. : 1

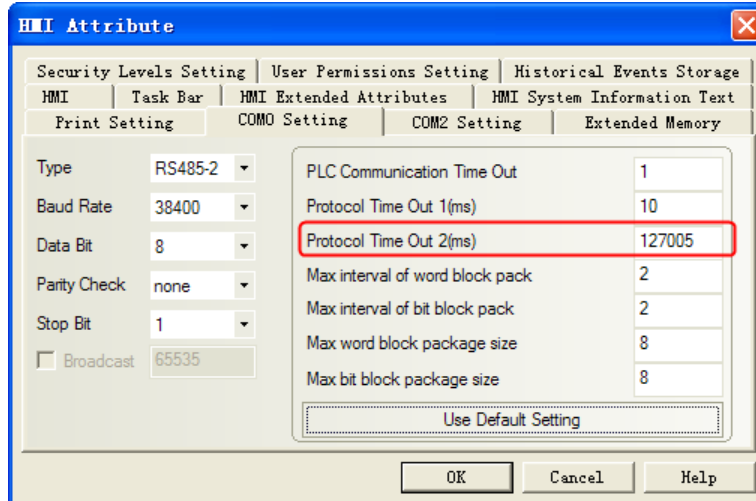

#### NOTE:

MAX Master setting:

Protocol Time Out 2 (ms) high three is MAX Master, default 127.

MAC address setting:

Protocol Time Out 2 (ms) low three is HMI MAC address, Range is 0-127. And it must be different from others which one in the token-ring.

PLC MAC address is setting in [PLC Attribute]-[Station No.], Range is 0~255.

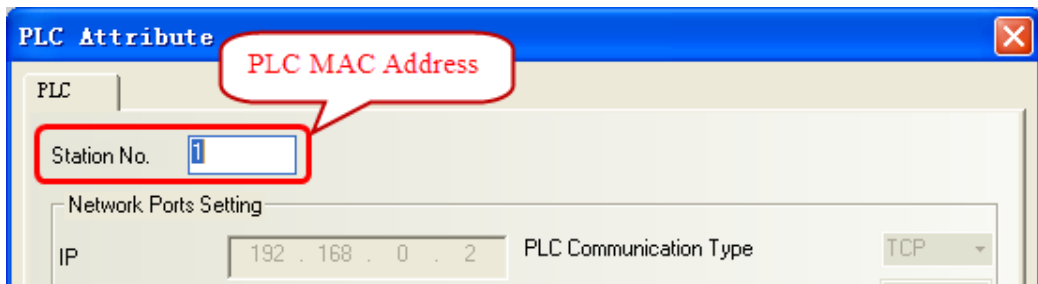

#### PLC Setting

Please refer to the communication equipment related documentation to set the parameter.

### BACnet MS/TP Extend Protocol:

#### HMI Setting

Default communication: 38400bps, 8, none, 1; station: 1

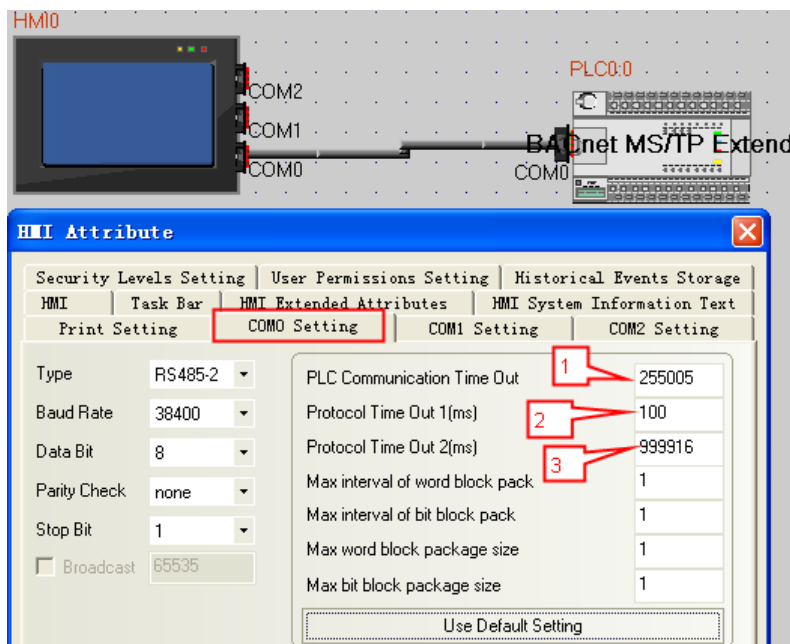

**Note:**

1. Lable one:
  - a. PLC Communication Time Out:255 stands for HMI’s ID number;
  - b. 005 stands for HMI’s MAC address, Range is 0~127. And it must be different from others which one in the token-ring.
2. Lable three:
  - a. Protocol Time Out 2:16 stands for register read and writer priority, range is 1~16;
  - b. 9999 stands for offset address; Range is 0~4194303;
  - c. PLC’s ID number=Offset address+The setting in [PLC Attribute]-[Station No.];

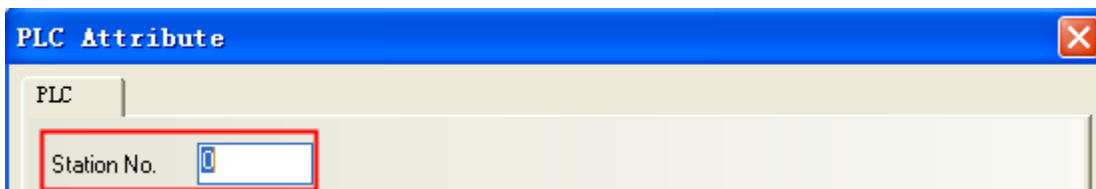

3. Use this protocol , the hmi must be updated kernel and rootfs by the kinco HMIware v2.2(build140805) or later.
4. This protocol only support new 4000 series and 5020 series HMI.

**PLC Setting**

Please refer to the communication equipment related documentation to set the parameter.

**© Network Communication Setting**

**BACnet IP protocol**

**HMI Setting**



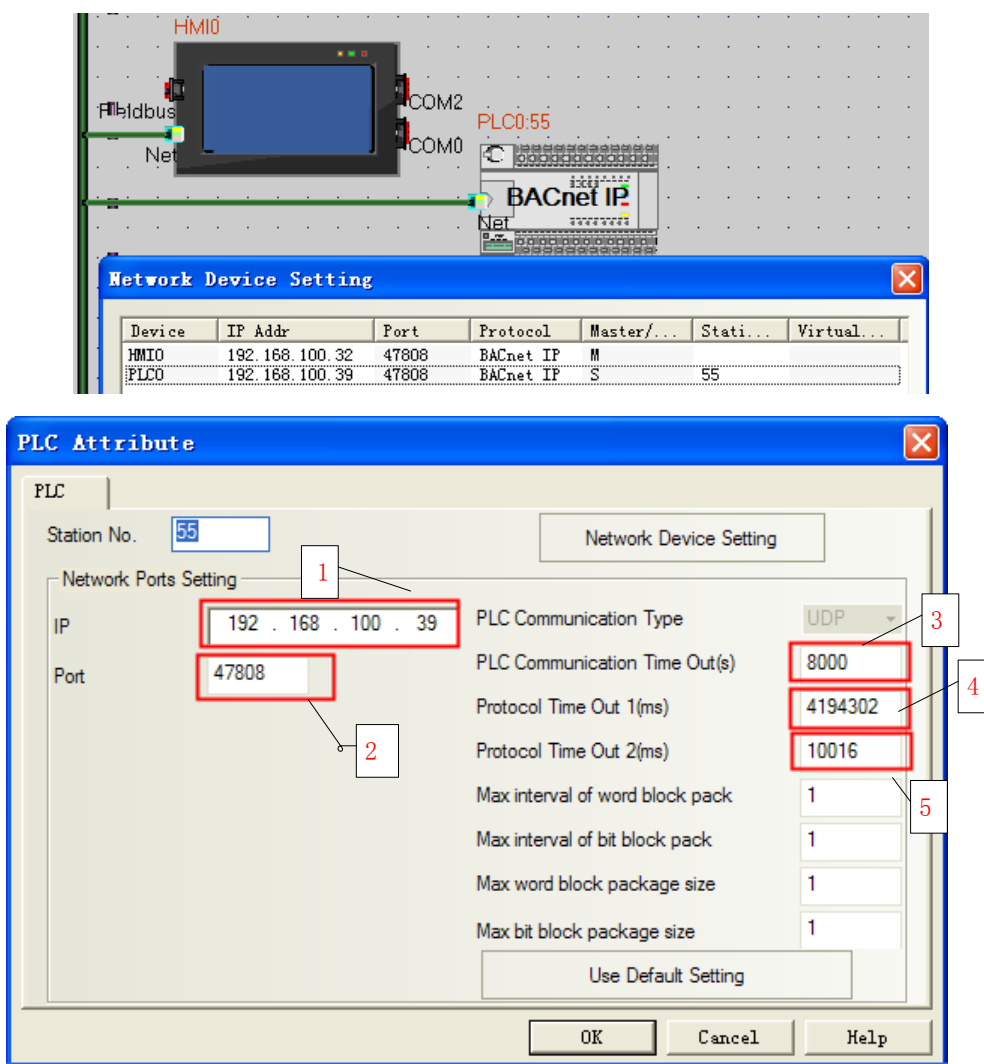

- NOTE:**
1. BACnet controller IP Address;
  2. Port ID: 47808, This the standard communication port of BACnet protocol.
  3. HMI ID: 8000, If there are more than two HMIs, user must set the different HMI ID for each HMI.
  4. Device ID: 4194302, the ID is the same as the actual device.
  5. The protocol time out: 100; register read and writer priority :16 range (1~16) ;
  6. Use this protocol, the HMI must be update kernel and rootfs by the kinco HMIware v2.2 (build141210) or later.
  7. This protocol only supports new 4000 series and 5020 series HMI.

### PLC Setting

Please refer to the communication equipment related documentation to set the parameter.

### BACnet IP Slave protocol

#### HMI Setting

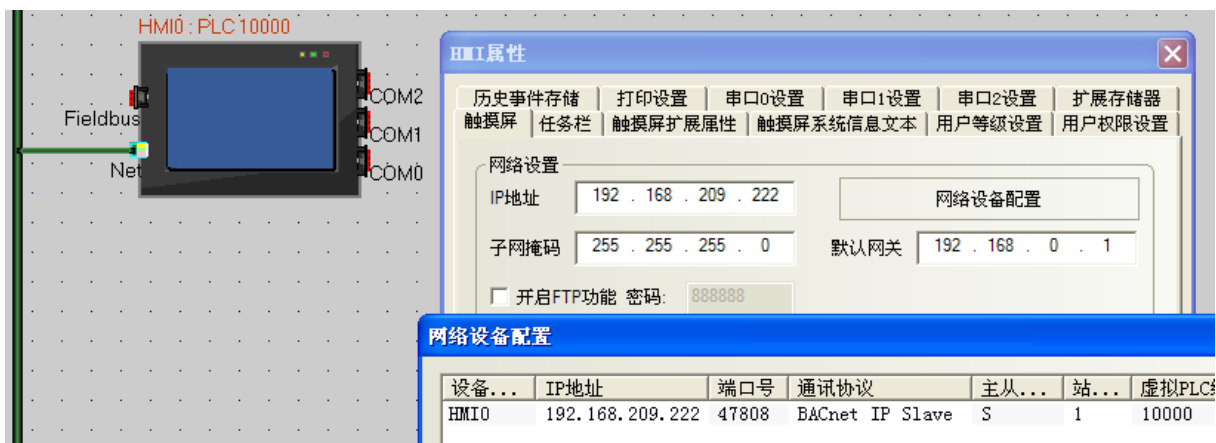

## PLC Setting

Please refer to the communication equipment related documentation to set the parameter.

## ◎ Supported Device

### BACnet MS/TP Protocol

Device	Bit Address	Word Address	Format	Notes
Binary Input	BI 0-65535	-----	DDDDD	
Binary Output	BO 0-65535	-----	DDDDD	
Binary Value	BV 0-65535	-----	DDDDD	
Analog Input	-----	AI 0-65535	DDDDD	Float
Analog Output	-----	AO 0-65535	DDDDD	Float
Analog Value	-----	AV 0-65535	DDDDD	Float
	-----	MI 0-65535	DDDDD	Float
	-----	MO 0-65535	DDDDD	Float
	-----	MV 0-65535	DDDDD	Float

### BACnet MS/TP Extend Protocol

Device	Bit Address	Word Address	Format	Notes
AI	-----	0-65535	DDDDD	Float
AO	-----	0-65535	DDDDD	Float
AV	-----	0-65535	DDDDD	Float
BI	0-65535	-----	DDDDD	
BO	0-65535	-----	DDDDD	
BV	0-65535	-----	DDDDD	
MI	-----	0-65535	DDDDD	
MO	-----	0-65535	DDDDD	
MV	-----	0-65535	DDDDD	

**Note**

1. AI、AO、AV is float data;
- 2.This protocol does not support direct online simulation;
3. Bit register transfer is recommended to use a timer to achieve.

**BACnet IP Protocol**

Device	Bit Address	Word Address	Format	Notes
Binary Input	BI 0-65535	-----	DDDDD	
Binary Output	BO 0-65535	-----	DDDDD	
Binary Value	BV 0-65535	-----	DDDDD	
Analog Input	-----	AI 0-65535	DDDDD	Float
Analog Output	-----	AO 0-65535	DDDDD	Float
Analog Value	-----	AV 0-65535	DDDDD	Float
	-----	MI 0-65535	DDDDD	
	-----	MO 0-65535	DDDDD	
	-----	MV 0-65535	DDDDD	

**BACnet IP Slave Protocol**

Device	Bit Address	Word Address	Format	Notes
BI	RB 600.0-600.F	-----	DDDDD	
BO	RB 610.0-610.F	-----	DDDDD	
BV	RB 620.0-620.F	-----	DDDDD	
AI	-----	RW 0-9	DDDDD	Float
AO	-----	RW 100-109	DDDDD	Float
AV	-----	RW 200-209	DDDDD	Float
MI	-----	RW 300-309	DDDDD	
MO	-----	RW 400-409	DDDDD	
MV	-----	RW 500-509	DDDDD	

**注意**

- 1.AI、AO、AV is float data;
- 2.This protocol does not support direct online simulation;
3. Bit register transfer is recommended to use a timer to achieve.

**© Cable Diagram****RS485**

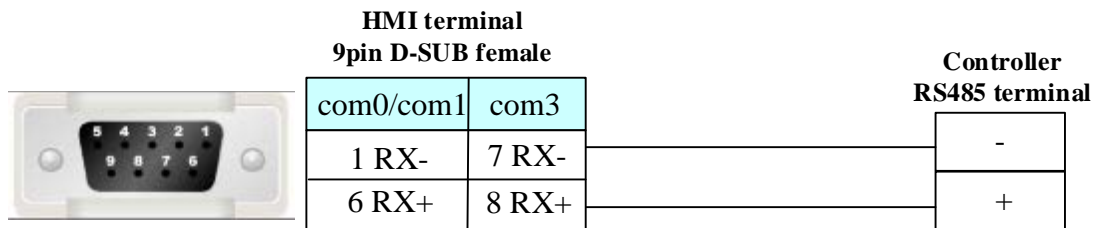

### Ethernet cable

Connecting PC and HMI use cross-ruling; communicating with hub or switch use cross-over cable or cross-ruling.

Refer to [3.3 Download by Network Ethernet](#) for method of making connection cable.

## 4.7 Baldor NextMove ES (Motion Controller)

### Serial Communication

Series	CPU	Link Module	Driver
NextMove ES	NextMove ES	RS232 on the CPU unit	Baldor NextMove ES

### System configuration

Series	CPU	Link Module	COMM Type	Parameter	Cable
NextMove ES	NextMove ES	RS232 on the CPU unit	RS232	<a href="#">Setting</a>	<a href="#">Your owner cable</a>

### Communication Setting

#### HMI Setting

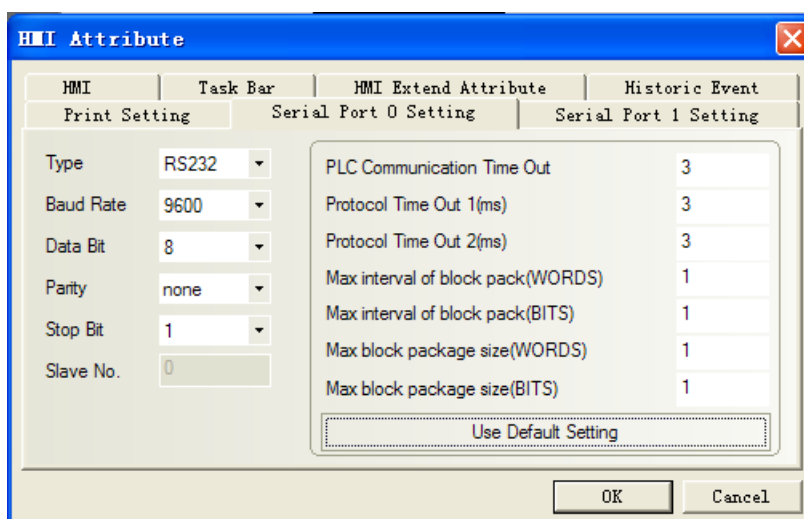

#### PLC Setting

Use the guide of the Workbench software

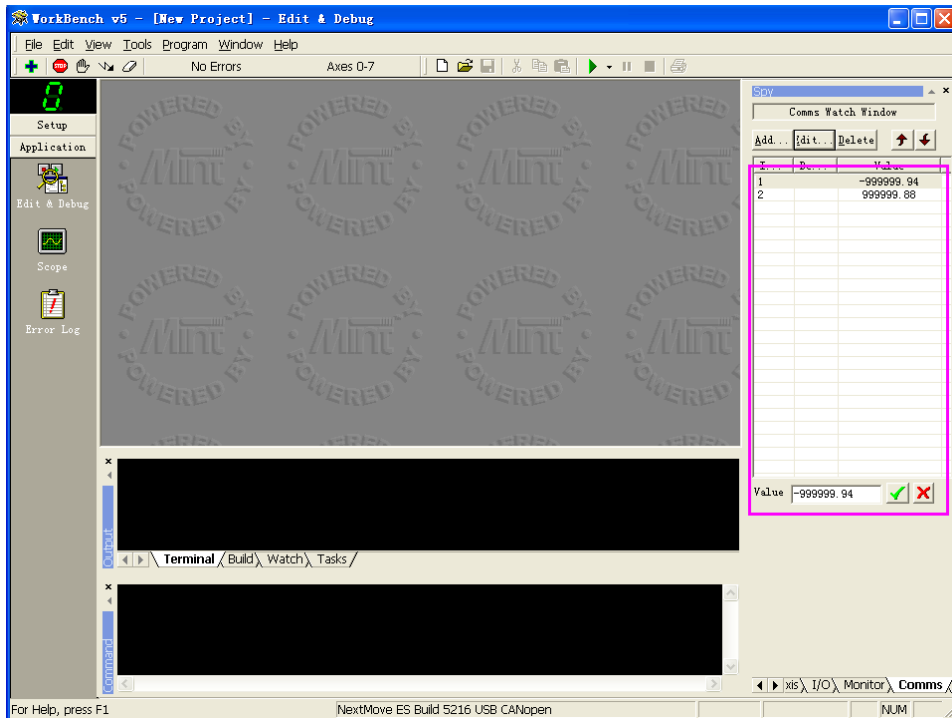
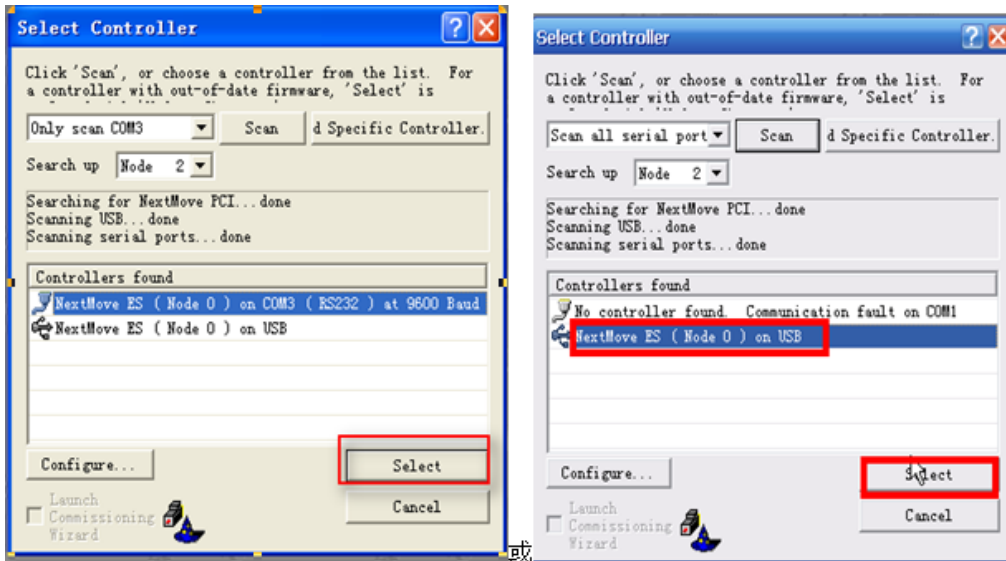
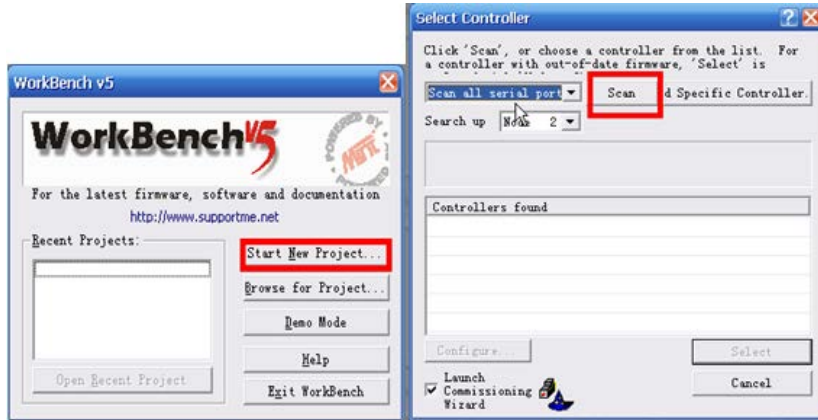

© Supported Device

(Only data of comms can be monitored, some address greater than or equal to 100 are read only. Please pay attention to matching the controller software configuration.)

Device	Bit Address	Word Address (Parameter symbol)	Format	Notes
Float	-----	1-255	DDD	Float Data type

### ◎ Cable Diagram

#### RS232 communication cable of HMI connecting to controller

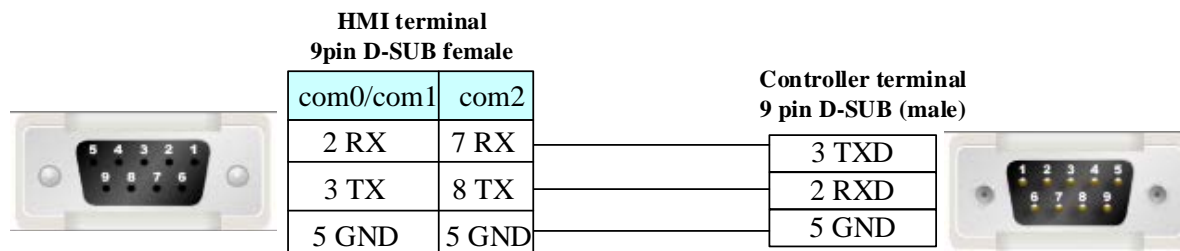

#### RS232 programming cable (Also can use USB, Power is +5v/±12v)

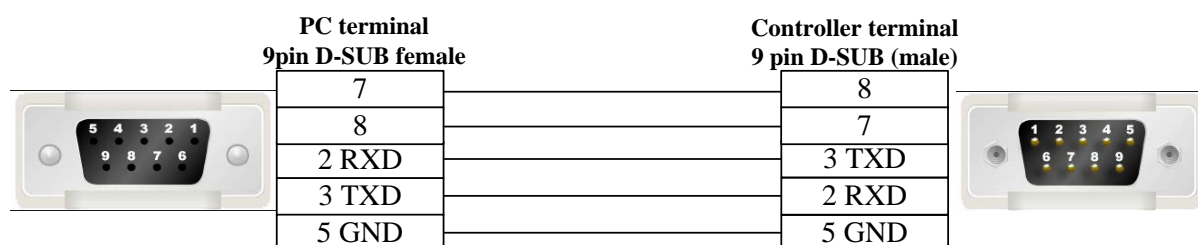

## 4.8 Barcode

### ◎ Serial Communication

Series	CPU	Link Module	Driver
Barcode	3800LTP-12E	RS232	Barcode
	MLJ-MS9590		
	SYMBOL LS4208-SR200007 ZZR		
	Flashcode LS3042		

### ◎ System configuration

Series	CPU	Link Module	COMM Type	Parameter	Cable
Barcode	3800LTP-12E	RS232	RS232	<a href="#">Setting</a>	<a href="#">Your owner cable</a>
	MLJ-MS9590				
	SYMBOL LS4208-SR200007 ZZR				
	Flashcode LS3042				

### ◎ Communication Setting

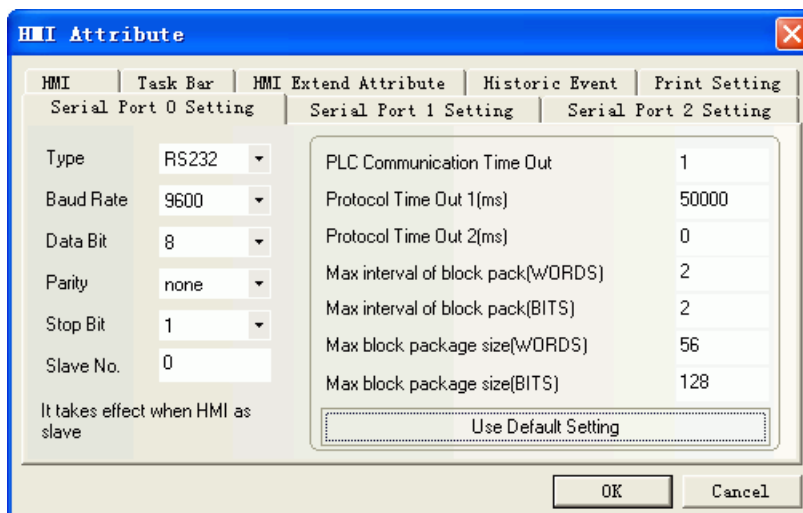

### ◎ Supported Device

Device	Bit Address	Word Address	Format	Notes
Word	-----	LW 8900-8999	DDDD	
Bit	-----	LB 8999	DDDD	

**NOTE:**

1. LW 8900-8999: the character after scanning, text and note book parts can display it.
2. LB 8999: the state of barcode is received or not. LB 8999=1 means the data is received.

### ◎ Cable Diagram

Connect the scanner and the COM port of HMI directly.

## 4.9 Baumuller

### ◎ Serial Communication

Series	CPU	Link Module	Driver
Baumuller	BM4413-ST0-02200-03	RS422 on the CPU unit	Baumuller

### ◎ System configuration

Series	CPU	Link Module	COMM Type	Parameter	Cable
Baumuller	BM4413-ST0-02200-03	RS422 on the CPU unit	RS422	<a href="#">Setting</a>	<a href="#">Your owner cable</a>

### ◎ Communication Setting

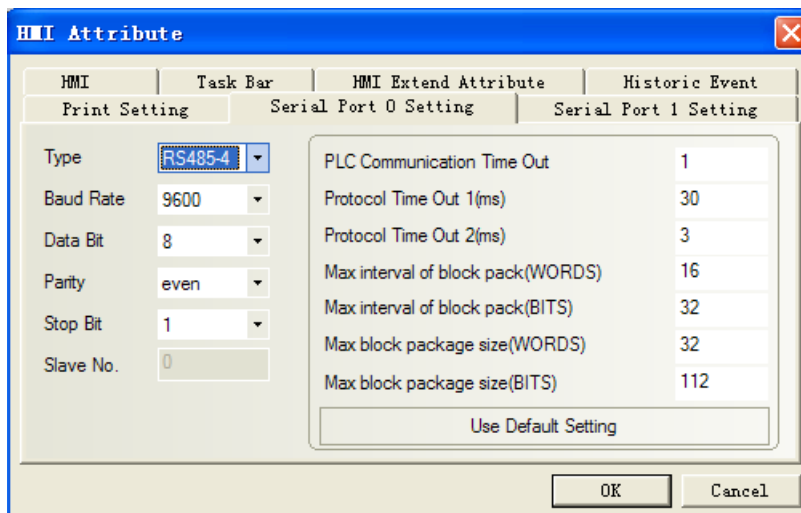

### ◎ Supported Device

Device	Bit Address	Word Address	Format	Notes
Bit type	DB_BIT0. 00-255. F	-----	DDD.H	
Word type	-----	DB0-255	DDD	

**Example:** DB2\_BIT address please input 0.F in the EV5000 software.

DB2 address please input 11 in the EV5000 software.

### ◎ Cable Diagram

#### RS422 communication cable

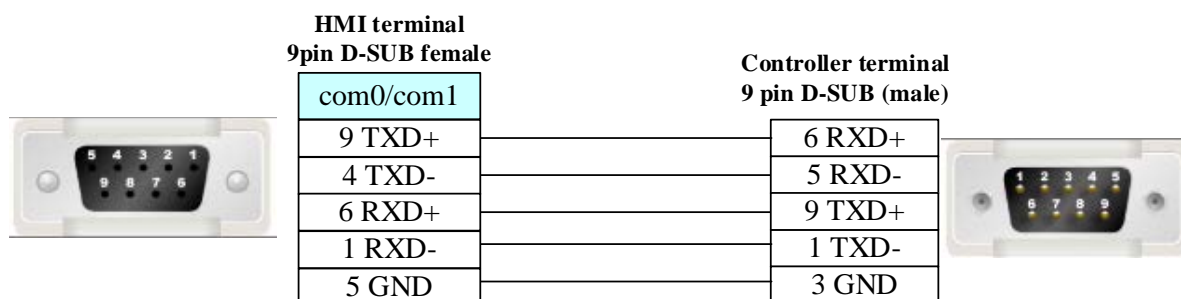

## 4.10 Beckhoff

### ◎ Network communication (support indirect online and direct online)

Series	CPU	Link Module	Driver
Embedded PC	CX9020 CX2030	Ethernet interface on CPU	<a href="#">Beckhoff TwinCAT 3 ADS_AMS (Ethernet)</a>
TwinCAT 2	CX9020	Ethernet interface on CPU	<a href="#">Beckhoff TwinCAT 2 ADS_AMS (Ethernet)</a>
TwinCAT2/ TwinCAT3	CX9020	Ethernet interface on CPU	<a href="#">Beckhoff TwinCAT PLC _Free Tag Names (Ethernet)</a>

### ◎ Ethernet System configuration



Series	CPU	Link Module	COMM Type	Parameter	Cable
Embedded PC	CX9020 CX2030	Ethernet interface on CPU	Ethernet	<a href="#">Setting</a>	<a href="#">Your owner cable</a>
TwinCAT 2	CX9020	Ethernet interface on CPU	Ethernet	<a href="#">Setting</a>	<a href="#">Your owner cable</a>
TwinCAT2/ TwinCAT3	CX9020	Ethernet interface on CPU	Ethernet	<a href="#">Setting</a>	<a href="#">Your owner cable</a>

### ◎ Network Communication Setting

#### Beckhoff TwinCAT 2 ADS\_AMS(Ethernet) protocol

#### HMI Setting

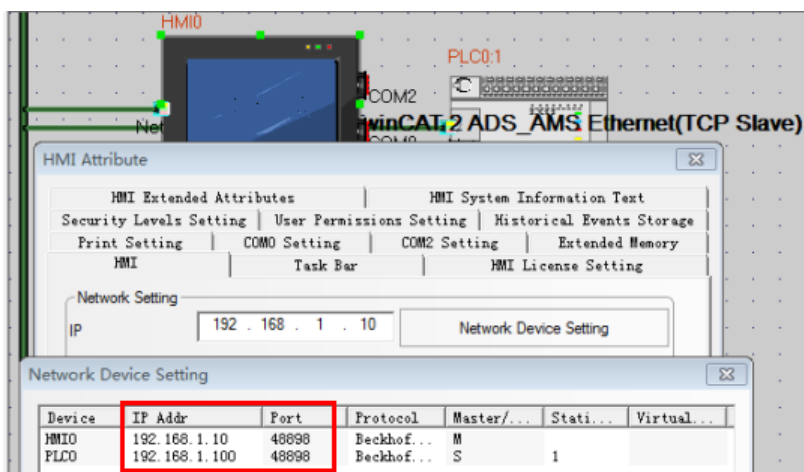

#### PLC Setting

1.Add routing table

Open System Manage ,and click Choose Target System



Pop up the Choose Target System form, and click Search Ethernet

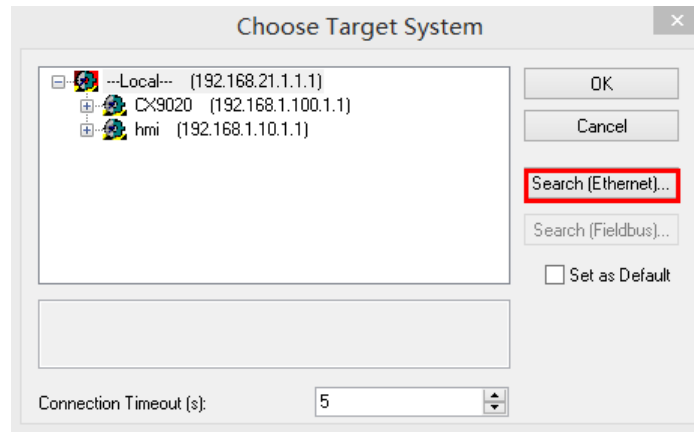

Then click Broadcast Search

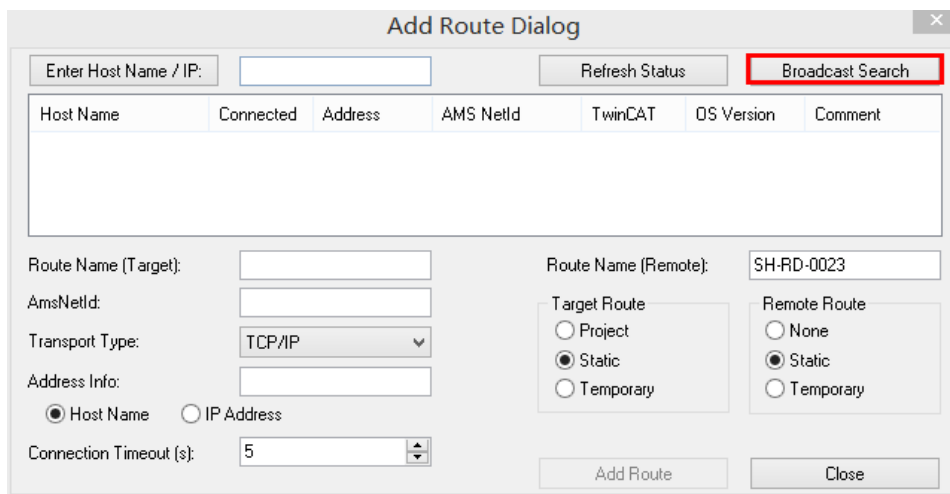

Select target controller

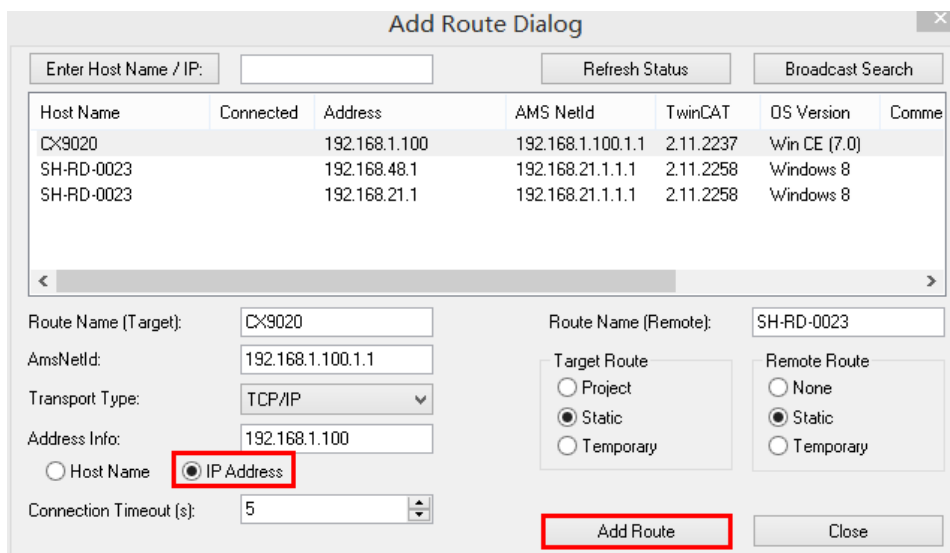

Click Add Route to enter the user login screen

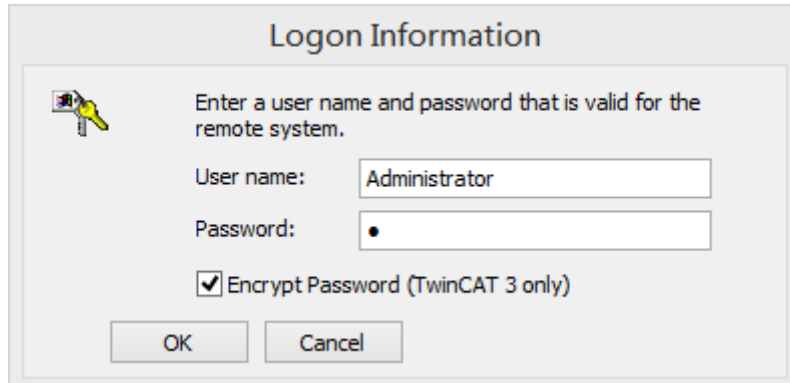

Enter user name and password

Factory settings: non CE system, user name: Administrator, password: 1

Factory settings: CE system, user name and password are blank

After you click OK, if successful communication, as shown below, the X tag will appear, click Close, and return to the previous form

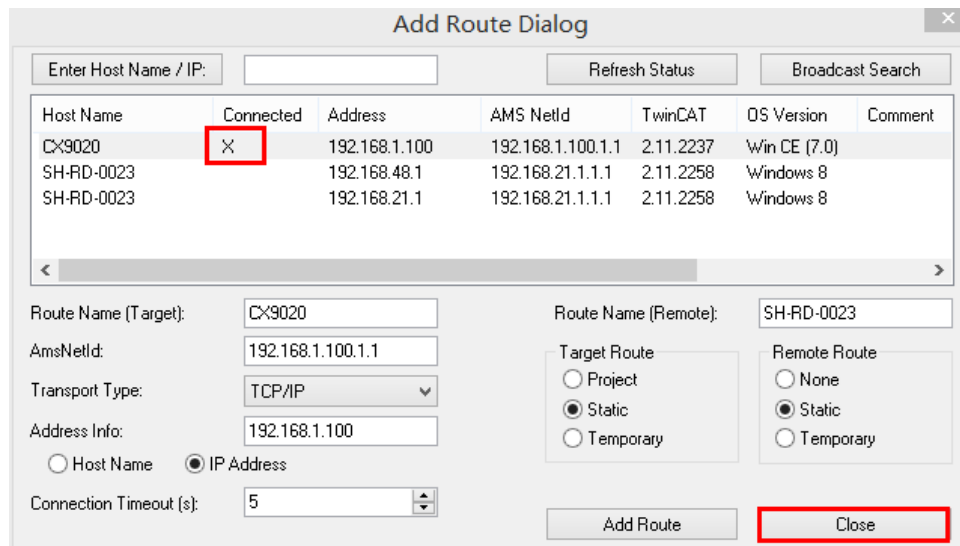

You can see that the routing table items that you just added appear in the list, select the controller you want to configure, and then click OK

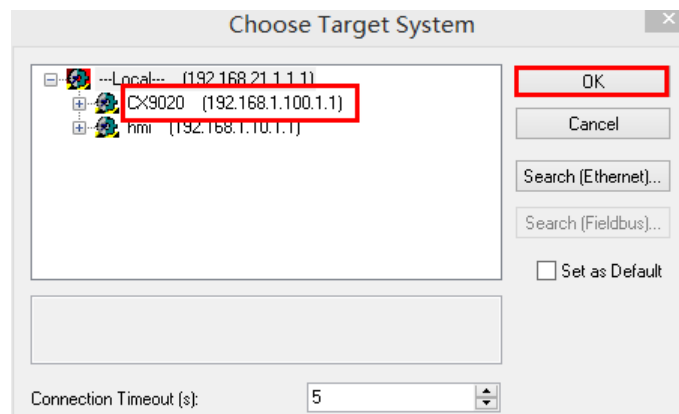

## 2. Add HMI static routing

Click Routes, then click Add to enter the add static routing interface

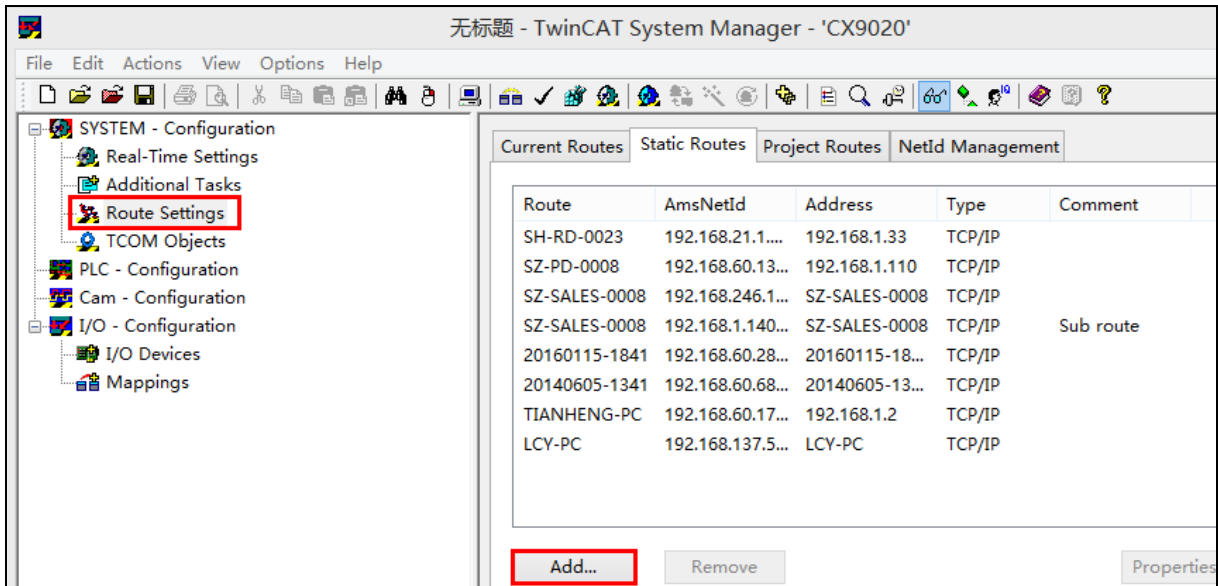

Go to the static routing interface and add HMI's static route (IP address is consistent with the IP address of the HMI), click Add Route, and then click Close

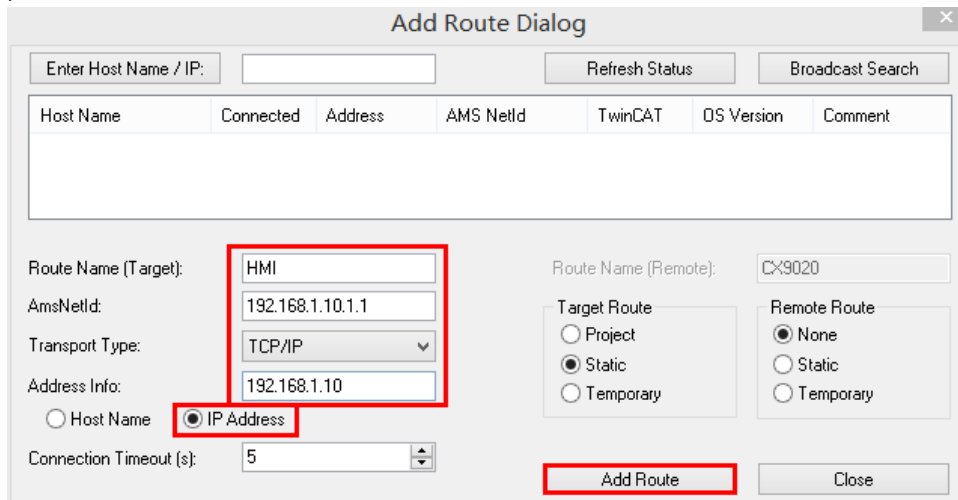

## 3. Modify PLC's AmsNetID number

If the first four of the PLC's AmsNetID numbers do not correspond to the IP address of the PLC, it needs to be modified to make it consistent

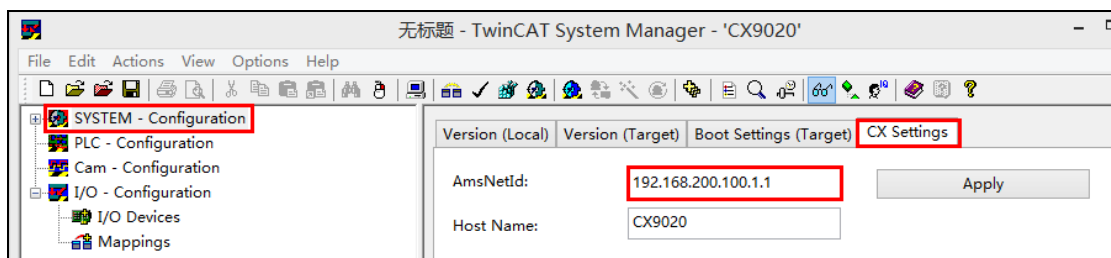

Click Apply, and then click Activate Configuration to download the parameters to PLC

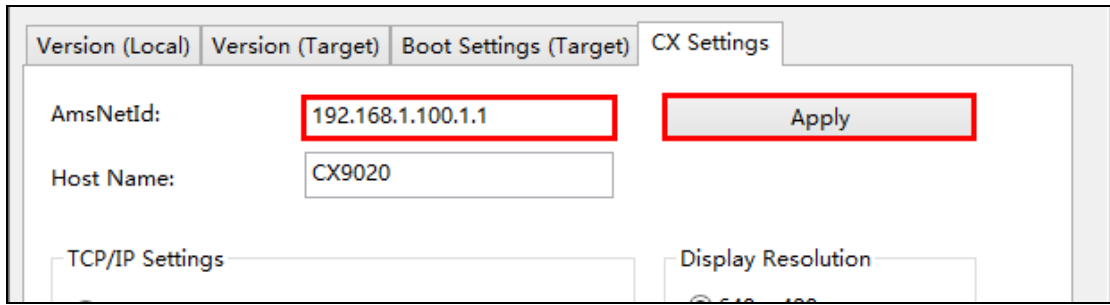

**Note: the HMI's ADS port defaults to 801; the first four bits of the AMS NetID number of the PLC controller must be consistent with the IP address of the PLC controller**

#### 4.add address variables

Open PLC Control, right-click POU's, add New POU, and then click OK

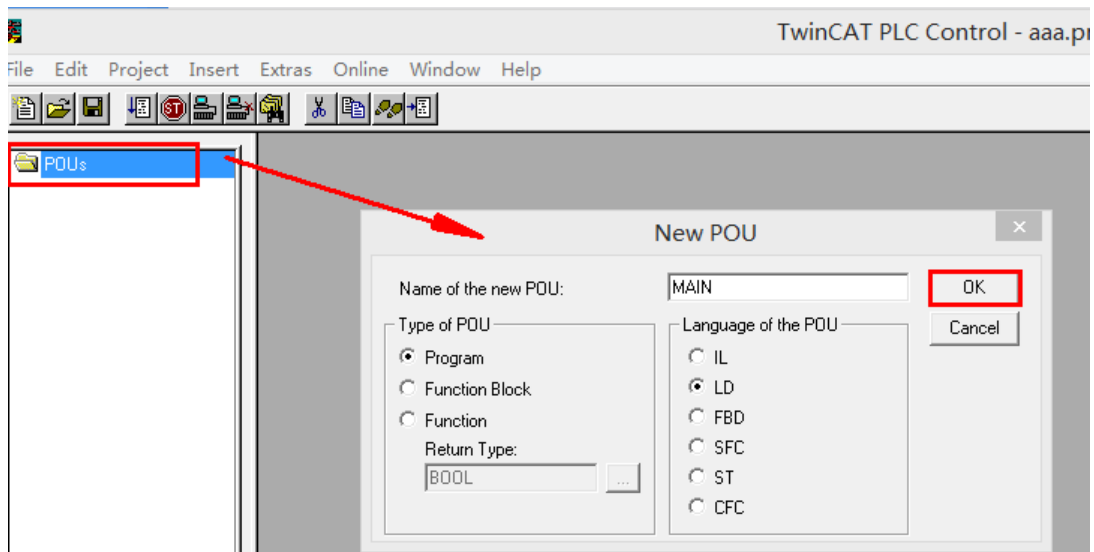

Pop up the "MAIN" dialog box, add variable declarations, and write programs

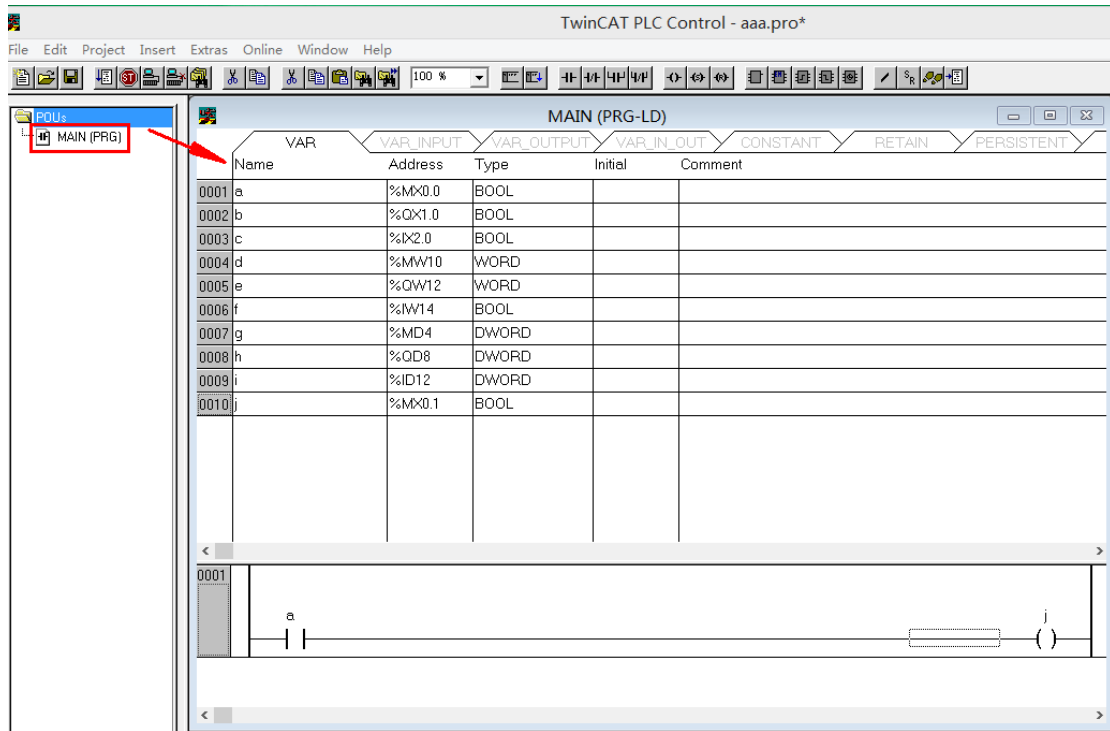

Add variable declaration formats:%MX0.0、%MW2、%MD4

### Beckhoff TwinCAT 3 ADS\_AMS(Ethernet) protocol HMI Setting

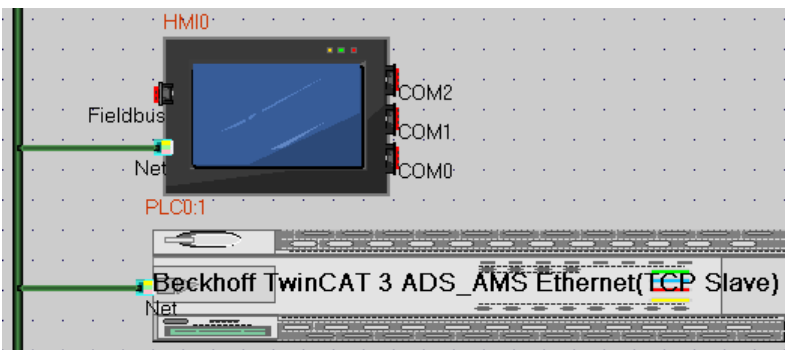

HMI Attribute

Security Levels Setting | User Permissions Setting | Historical Events Storage

Print Setting | COM0 Setting | COM2 Setting | Extended Memory

HMI | Task Bar | HMI License Setting | HMI Extended Attributes | HMI System Information Text

Network Setting

IP: 192 . 168 . 0 . 3      Network Device Setting

Subnet Mask: 255 . 255 . 255 . 0       Open FTP Password:

Default Gateway: 192 . 168 . 0 . 1      888888

Network Device Setting

D...	IP Addr	Port	Protocol	Master
HMI0	192.168.100.10	48898	Beckhoff TwinCAT 3 ADS_AMS Ethernet(TCP)	M
PLC0	192.168.100.16	48898	Beckhoff TwinCAT 3 ADS_AMS Ethernet(TCP Slave)	S

**NOTE:** Because of the structure limitation in HMIsoftware , this protocol only supports the controller with the ADS port ,number 851.

**PLC Setting**

1. Setting IP address

Connecting the X200 DVI port with computer monitor,d the IP address of PLC can be modified in network device settings in HMI Attribute,and the screen must be in the same network with PLC

2. Setting NetID

NetID is a 6-segment numeric code and the last two sections of the TwinCAT controller NetID are always "1" while the first 4 sections can be customized. Because of the structure limitation in Kinco HMIsoftware, it must be required the first four NetID are consistent with plc IP address. For example, the IP address is 192.168.100.16, so NetID must be set to 192.168.100.16.1.1

1) Modify the NetID number of PLC. If the first four of the NetID of PLC is inconsistent with the IP address of PLC, it needs to be modified to make it consistent.

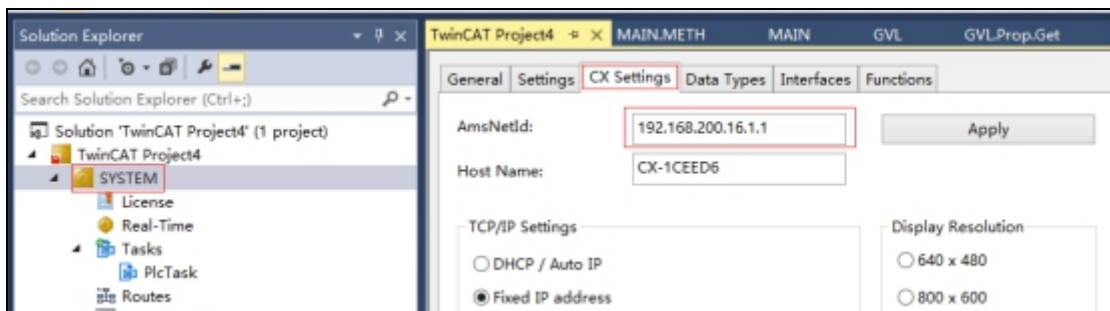

2) Click“Apply”,and then click“Activate Configuration” , and then download it to PLC.

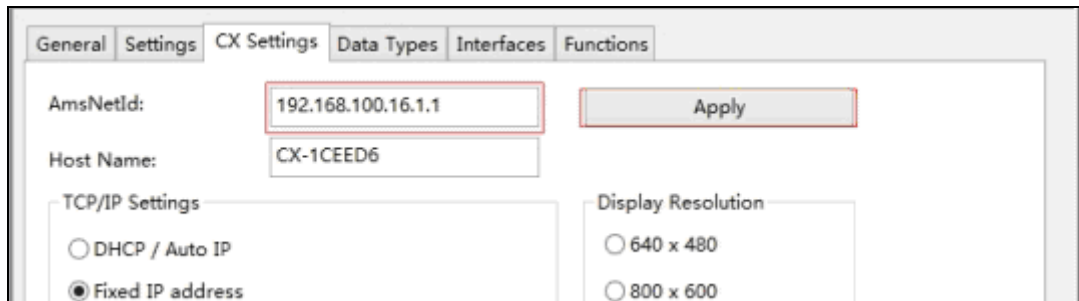

3. Add Routes to the TC3 System | Routes.

After setting up the IP address and NetID, you can add the routing table.

1) Click“Choose Target System”

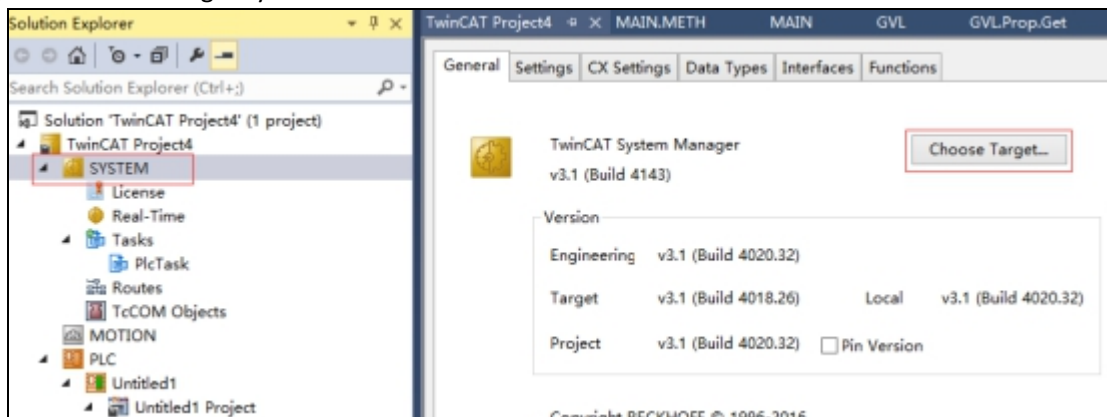

2) After popping up the "Choose Target System" form and click "Search Ethernet"

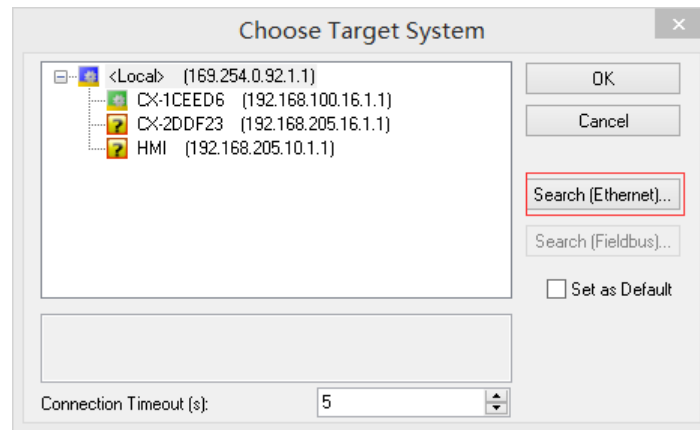

3) Click "Broadcast Search" in popping window

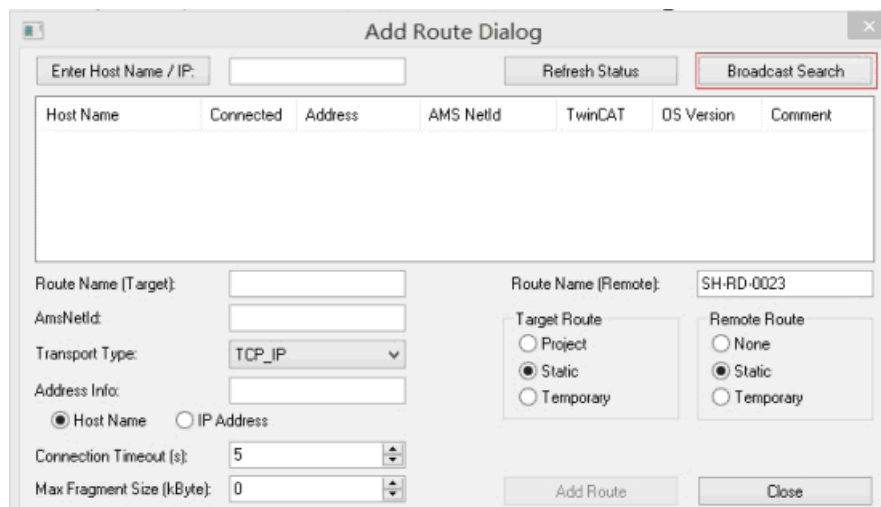

4) Select the target controller and the IP Address mode.

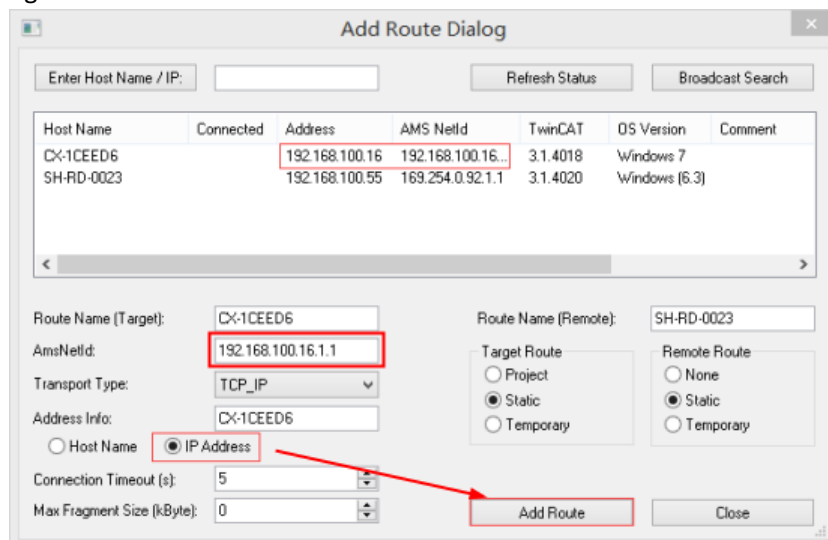

5) Click "Add Route" to user login screen.





Enter the username and password

Factory setting: non-CE system, user name: Administrator, password: 1.

Factory setting: CE system, user name and password are blank.

After clicking OK, if communicate successfully, the X mark will appear as shown in the following figure,

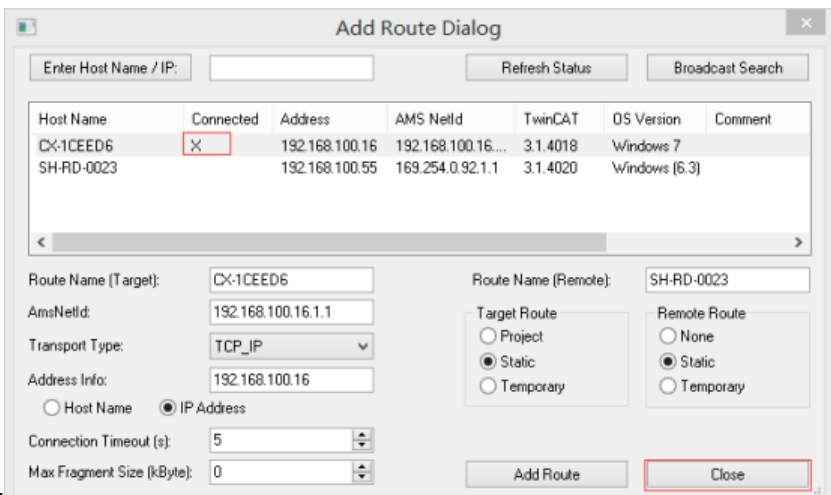

Click "Close" to return to the previous form. You can see the newly added routing table item appears in the list, and then select the controller to be configured, and then clicks "OK"

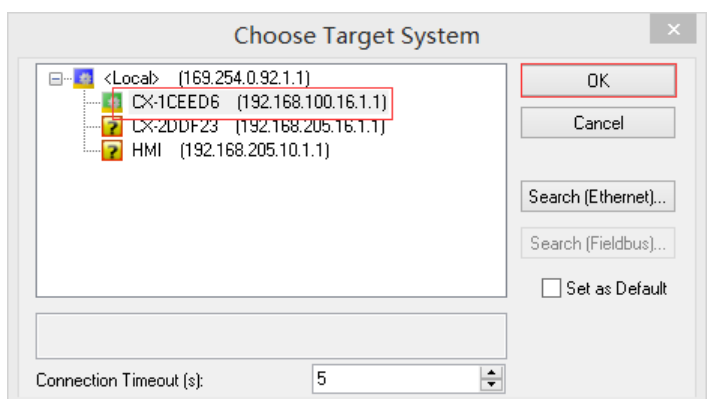

2. Add static routing for HMI.

- 1) Click "Routes", then click "Add" to enter the static routing interface.

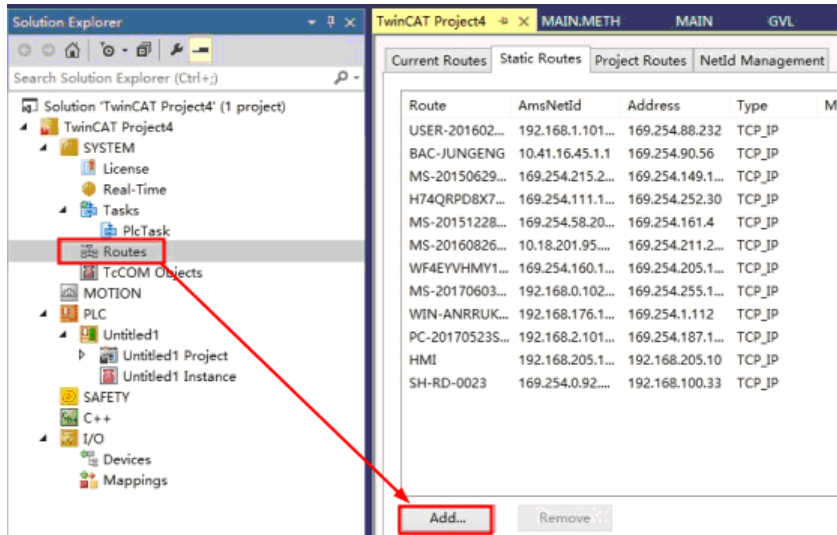

2) Enter the static routing interface, Add the static Route of HMI (the IP address is consistent with the IP address of the touch screen), click "Add Route", then click "Close".

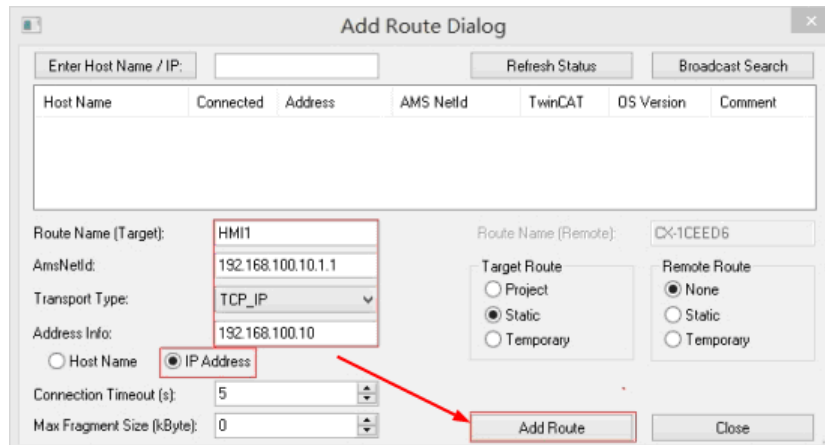

3. Add PLC communication variable.

1) Right click "PLC" and select "Add New Item"

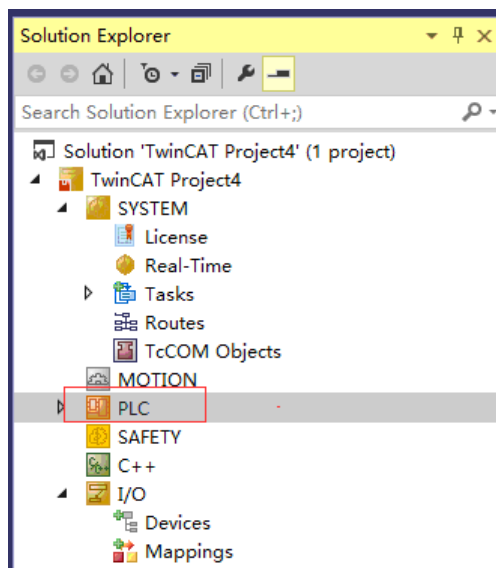

2) After popping up the "Add New Item" dialog box and select "Add"

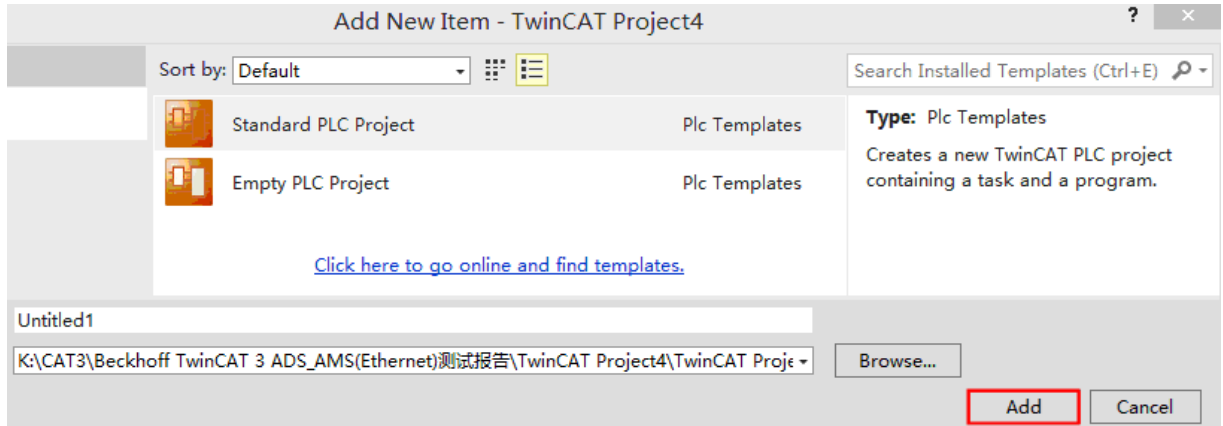

3) Right click "GVLs", select "Add" -- "Global Variable List", then Add the Variable address.  
 (variable address add format : AT %MW1:WORD;With the AT % MX0.15: BOOL)

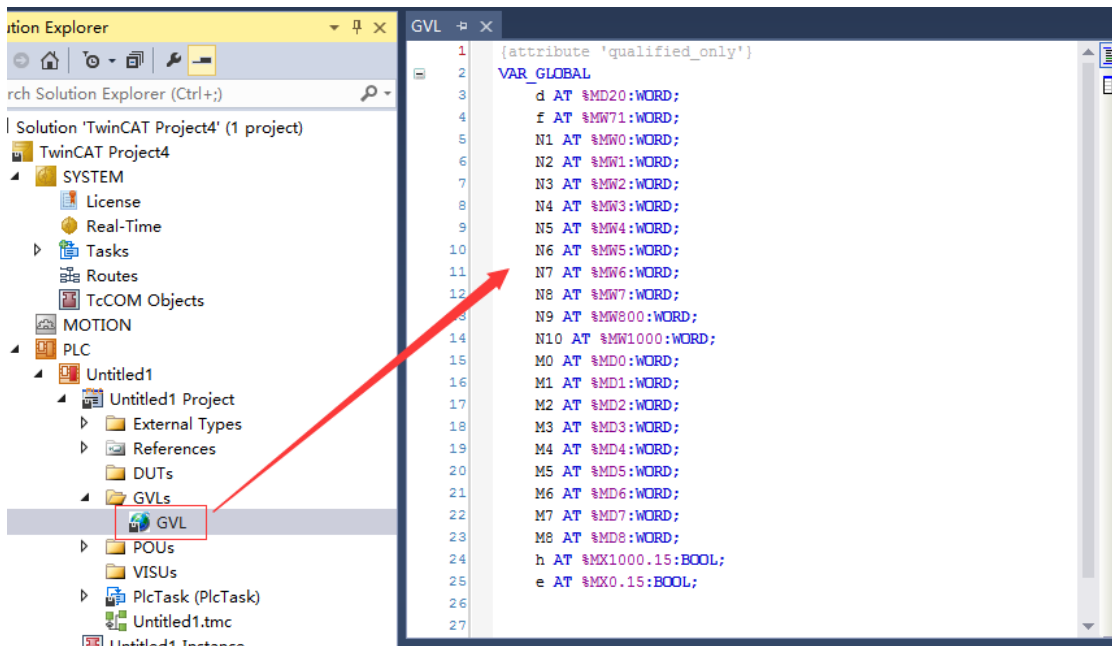

## Beckhoff TwinCAT PLC\_Free Tag Names (Ethernet) protocol HMI Setting

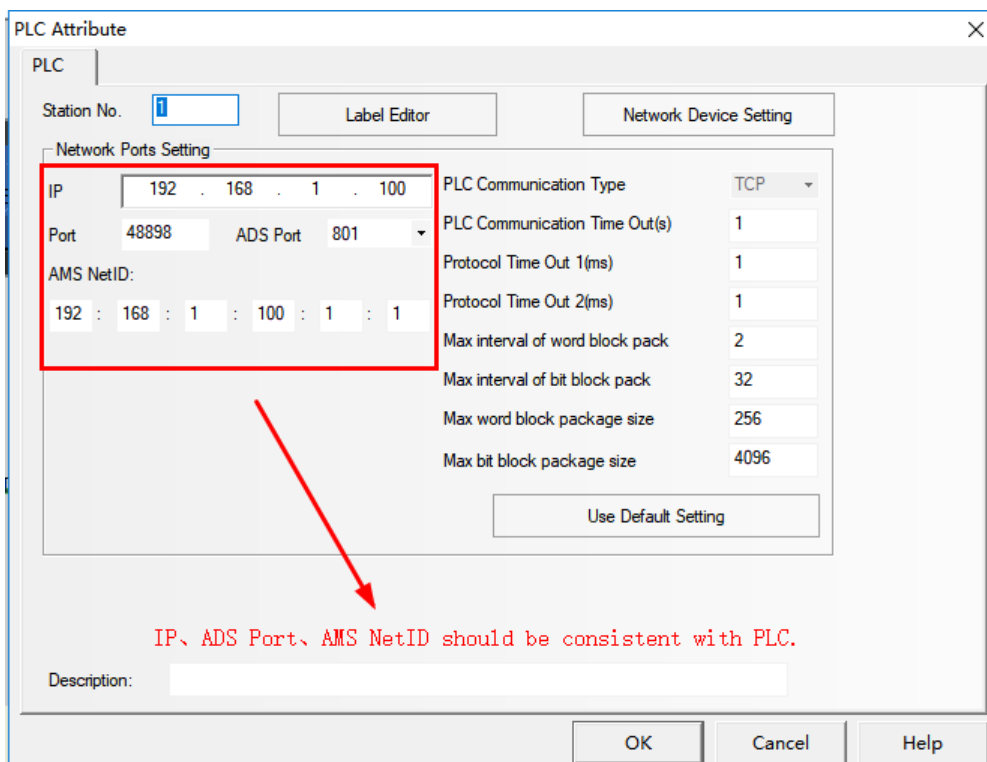
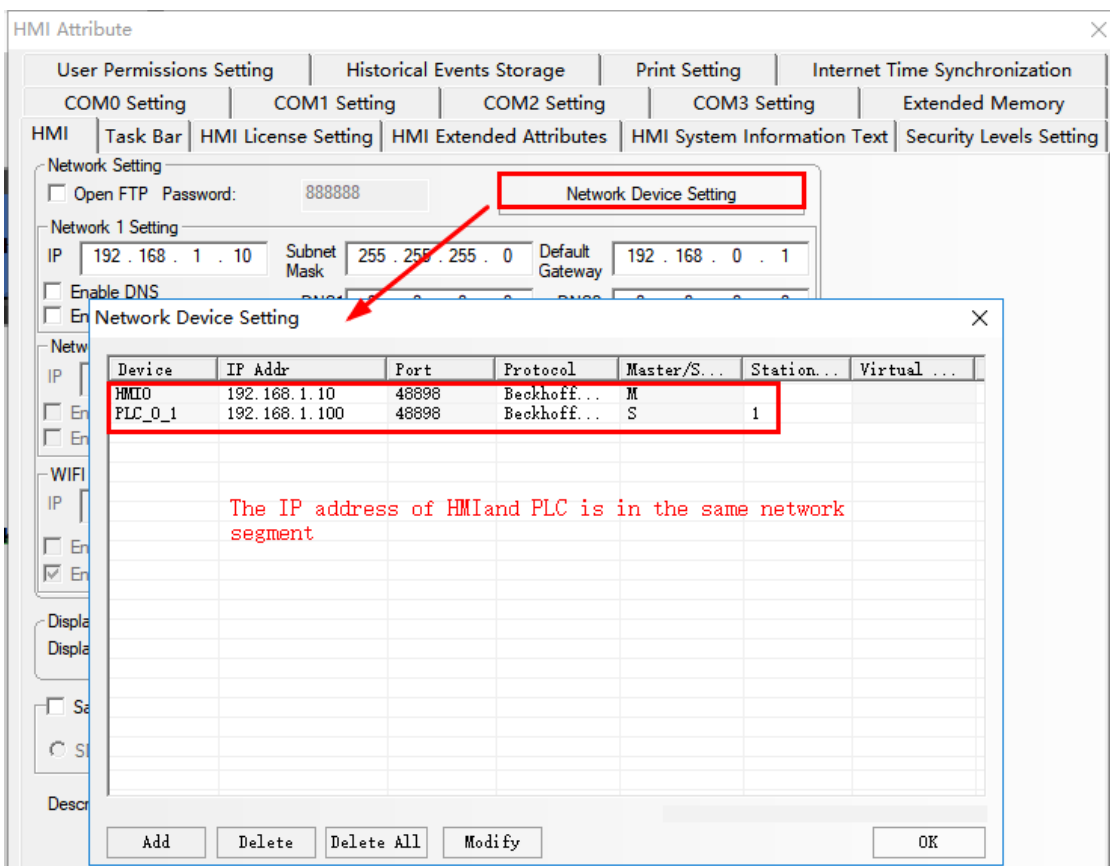

Note: 1.the default ADS port of CAT2 is 801, and the ADS port of CAT3 is 851, which can be viewed through PLC software;2.Direct online simulation is not supported.

### PLC Setting

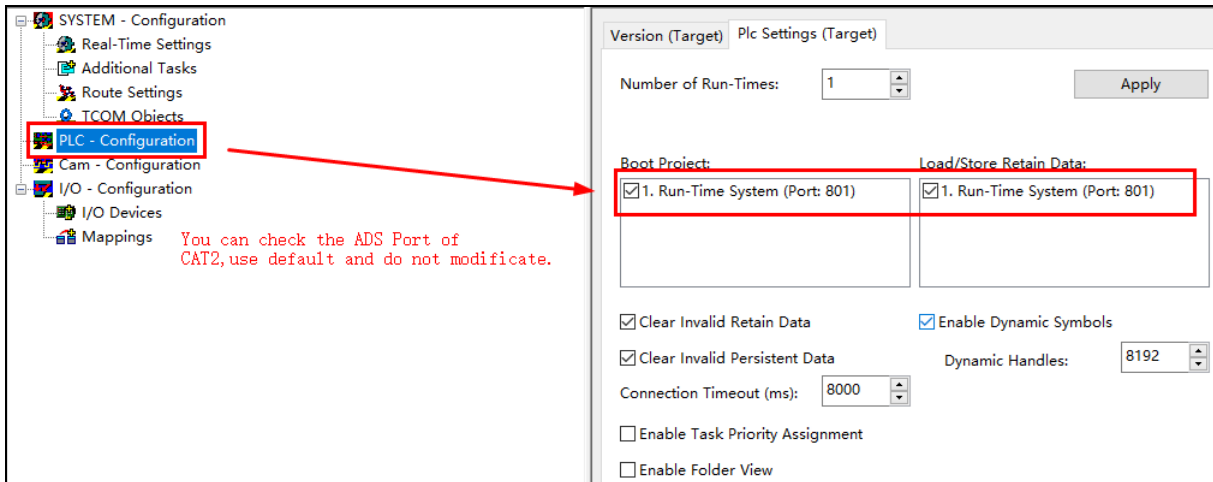
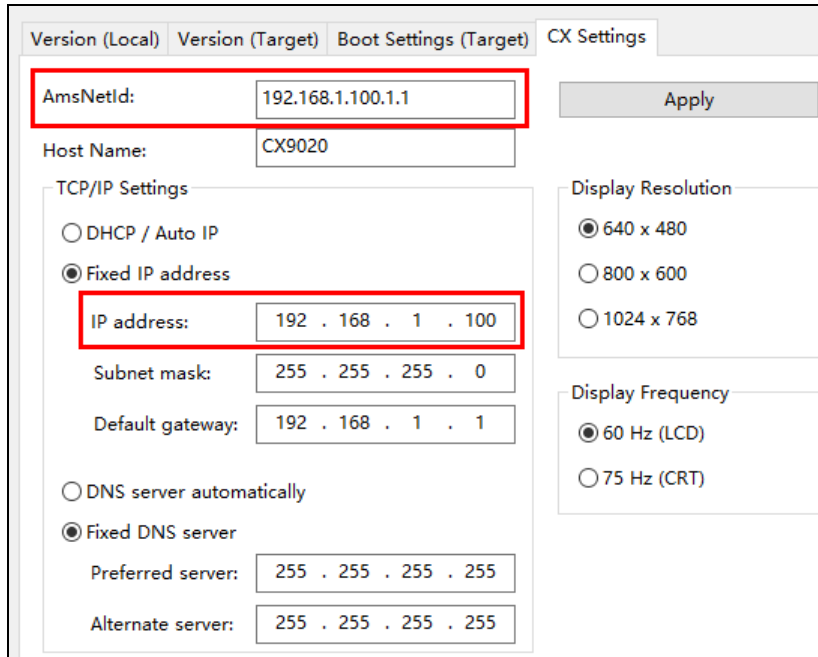

You can check the ADS Port of CAT2, use default and do not modificate.

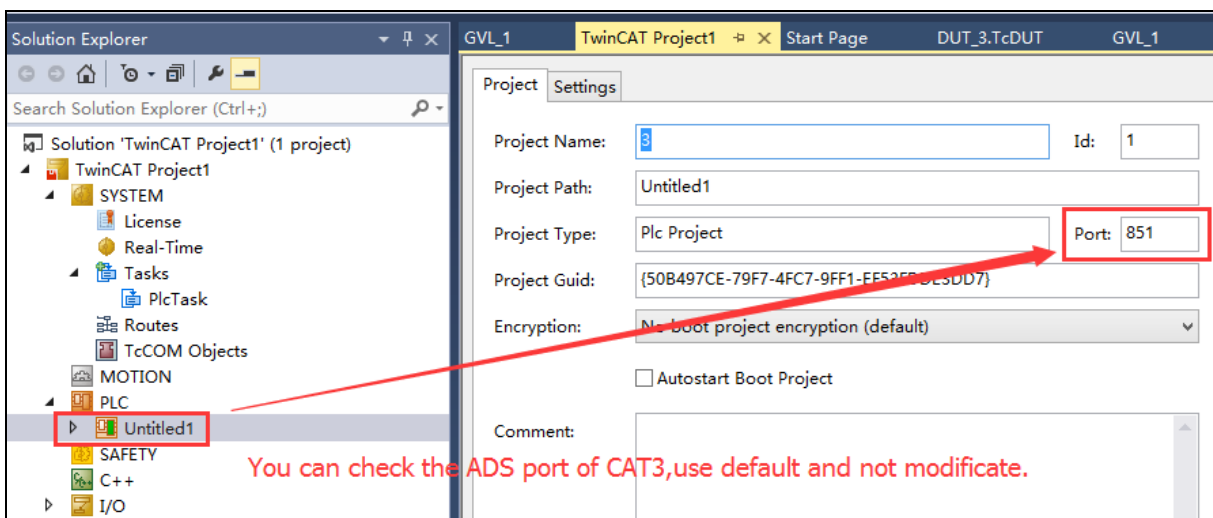

You can check the ADS port of CAT3, use default and not modificate.

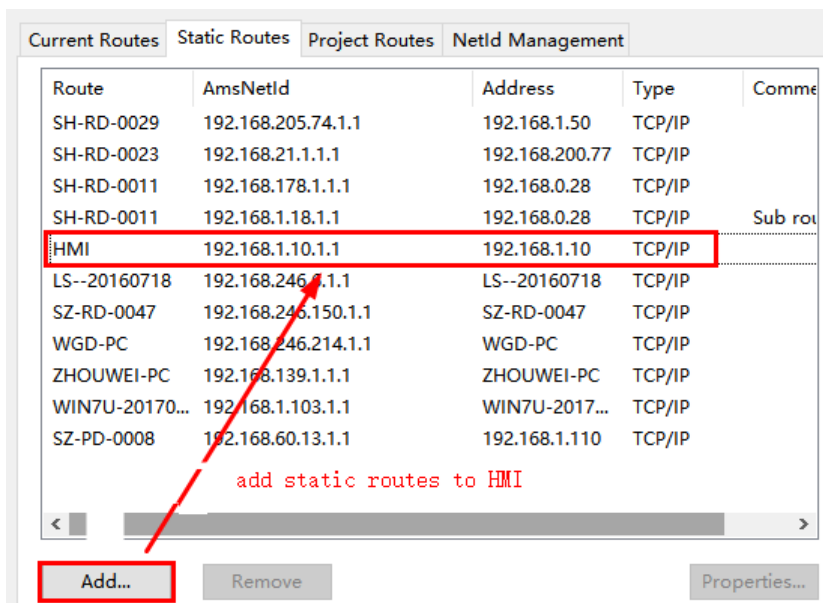

### Import Label

Compiled files generated by TwinCAT2 and TwinCAT programming software can be directly imported into Kinco Dtools. The following steps show how to import address labels.

- ① PLC attribute>>Label Editor>>Import,pop up the prompt box of importing tags.

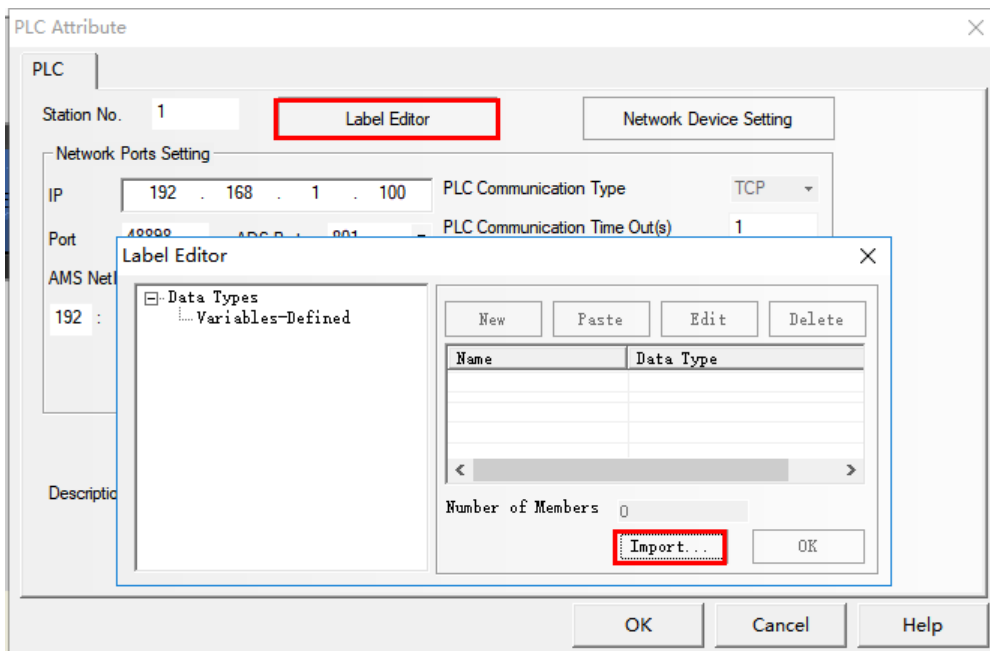

- ② Select the version of PLC software (TwinCAT2 is 2, TwinCAT3 is 3)

The standard file type of TwinCAT2 is.TYP, and the standard file type of TwinCAT3 is.TcGVL,.TcPOU. Click browse, select file type, and then click OK.

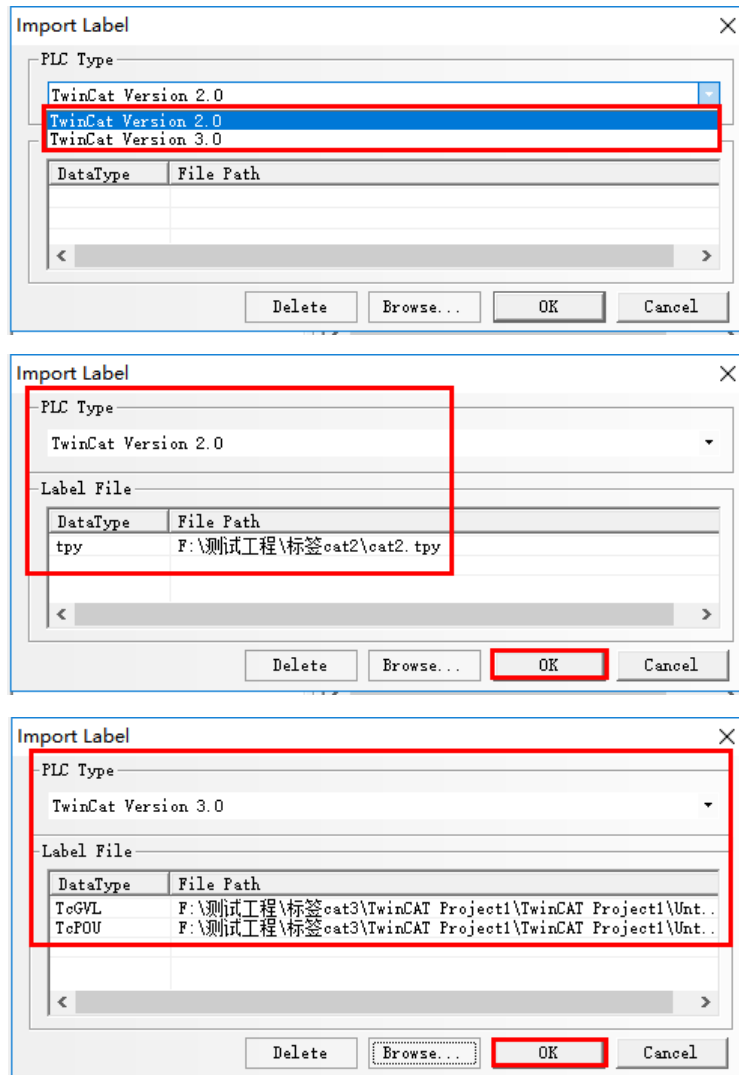

Note: Dtools software does not support data types such as structure, commons, enumerations, etc. CAT3 tags are generally not imported. TcDUT text types.

③Successfully imported labels

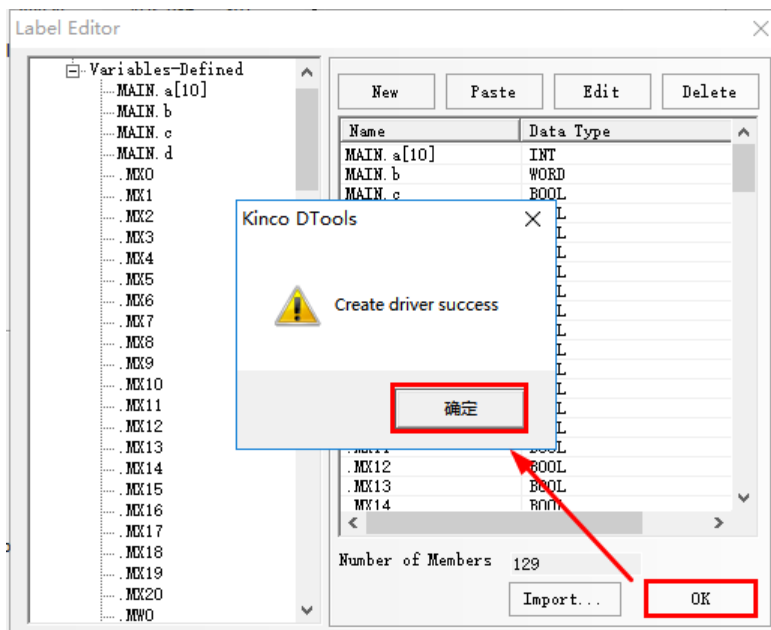

## © Support Date Type

### Beckhoff TwinCAT 2 ADS\_AMS (Ethernet)

Device	Bit Address	Word Address	Format	
Auxiliary relay	MX 0.0-65535.7	-----	DDDDD.O	
Output Relay	QX 0.0-65535.7	-----	DDDDD.O	
Input Relay	IX 0.0-65535.7	-----	DDDDD.O	
32-bit Auxiliary register	-----	MD0-65535	DDDDD	
Auxiliary registre	-----	MW0-65535	DDDDD	
32-bit Output register	-----	QD0-65535	DDDDD	
Output register	-----	QW0-65535	DDDDD	
32-bit Input register	-----	ID0-65535	DDDDD	
Input register	-----	IW0-65535	DDDDD	

**Note:** MW address can only be even number, MD address can only be multiples of 4;

The correspondence between MD and MW: MD0 corresponds to MW0 and MW2; MD4 corresponds to MW4 and MW6; MD8 corresponds to MW8 and MW10.....

### Beckhoff TwinCAT 3 ADS\_AMS (Ethernet)

Device	Bit Address	Word Address	Format	Notes
Auxiliary relay	MX 0.0-65535.7	-----	DDDDD.O	
Input relay	IX 0.0-65535.7	-----	DDDDD.O	
Output relay	QX 0.0-65535.7	-----	DDDDD.O	
32 bit Auxiliary relay	-----	MD 0-65535	DDDDD	
Auxiliary relay	-----	MW 0-65535	DDDDD	
32 bit Input relay	-----	ID 0-65535	DDDDD	
Input relay	-----	IW 0-65535	DDDDD	
32 bit Output relay	-----	QD 0-65535	DDDDD	
Output relay	-----	QW 0-65535	DDDDD	

Note: 1. The corresponding relationship between MD and MW: MD0 corresponds to MW0 and MW1; MD1 corresponds to MW2 and MW3;.....;

2. MW1, MW3, MW5, MW7...It can only be 16bit, not 32bit in CE system.

### Beckhoff TwinCAT PLC \_Free Tag Names (Ethernet)

Date Type	data format	Notes
Bool	bit	
Word	16-bit Decimal, Hex, Binary	
Int	16-bit Decimal, Hex, Binary	
UInt	16-bit Decimal, Hex, Binary	



DWord	32-bit Decimal, Hex, Binary	
DInt	32-bit Decimal, Hex, Binary	
Real	32-bit Float	
UDInt	32-bit Decimal, Hex, Binary	

◎ **Cable Diagram**

Connecting PC and HMI use cross-ruling; communicating with hub or switch use cross-over cable or cross-ruling.

Refer to [3.3 Download by Network Ethernet](#) for method of making connection cable.

**4.11 Bosch Rexroth KVFC+ (Inverter)**

◎ **Serial Communication**

Series	CPU	Link Module	Driver
KVFC+		RS485	Bosch Rexroth KVFC+

◎ **System configuration**

Series	CPU	Link Module	COMM Type	Parameter	Cable
KVFC+		RS485 on the CPU unit	RS485	<a href="#">Setting</a>	<a href="#">Your owner cable</a>

◎ **Communication Setting**

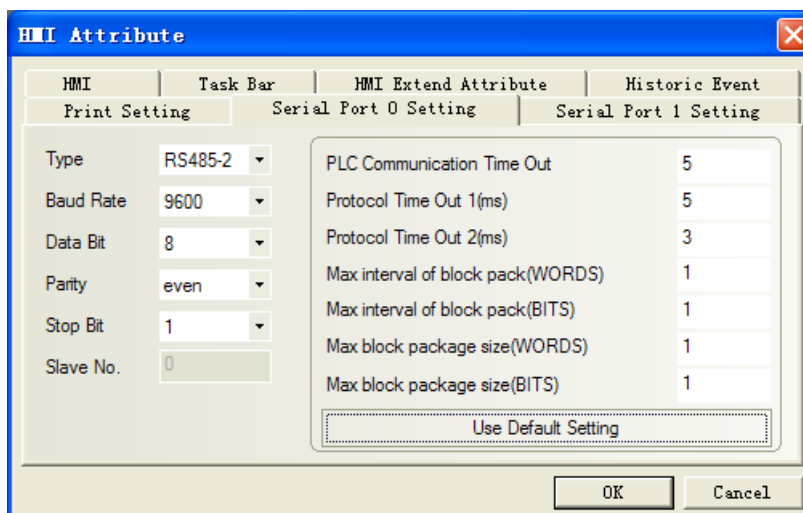

◎ **Supported Device**

Device	Bit Address	Word Address	Format	Notes
Start/Stop	STW0~3	-----	D	STW0 open, start. STW0 close, stop. STW1 close, positive rotation.

				STW1 open, negative rotation. STW2 REV inching turning. STW3 FWD inching turning.
Set frequency	-----	HSW 0	D	
Basic Function Block	-----	B 0~41	DD	B16 acceleration time. B17 deceleration time.
Deviation alarm	-----	E 0~41	DD	
Programmable control function array	-----	P 0~37	DD	
High function array	-----	H 0~38	DD	
D array	-----	D 0~6	D	D0: output power. D2: running current.

◎ Cable Diagram

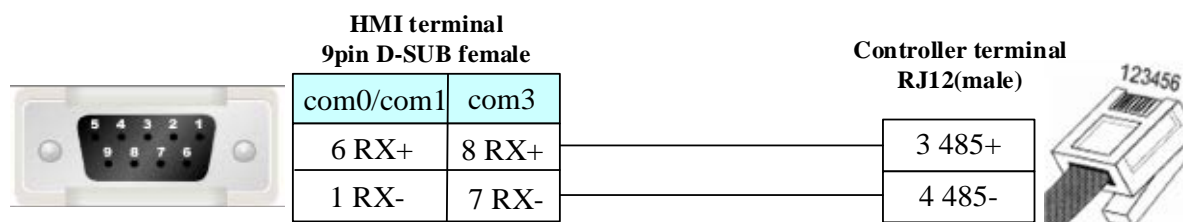

4.12 Bosch Rexroth

◎ Serial Communication

Series	CPU	Link Module	Driver
PPC-R	PPC-R22.1 13VRS	RS232 on the CPU unit	Bosch Rexroth
		RS485 on the port	
L	L40	RS232 on the CPU unit	
	L20	RS232 on the CPU unit	
IndraDrive C	HCS02	RS232 on the CPU unit	Bosch Rexroth SIS

◎ System configuration

Series	CPU	Link Module	COMM Type	Parameter	Cable
PPC-R	PPC-R22.1 13VRS	RS232 on the CPU unit	RS232C	<a href="#">Setting</a>	<a href="#">Your owner cable</a>
		RS485 on the port	RS485	<a href="#">Setting</a>	<a href="#">Your owner cable</a>
L	L40 L20	RS232 on the CPU unit	RS232C	<a href="#">Setting</a>	<a href="#">Your owner cable</a>
IndraDrive C	HCS02	RS232 on the CPU unit	RS232	<a href="#">Setting</a>	<a href="#">Your owner cable</a>

◎ Communication Setting

### PPC-R communication setting

RS232 communication: 19200, 8, even, 1; station number: 128

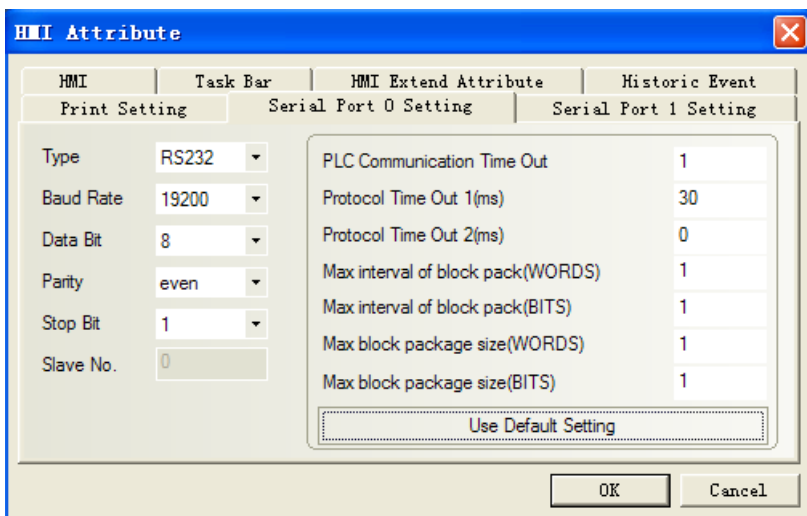

### RS485 communication

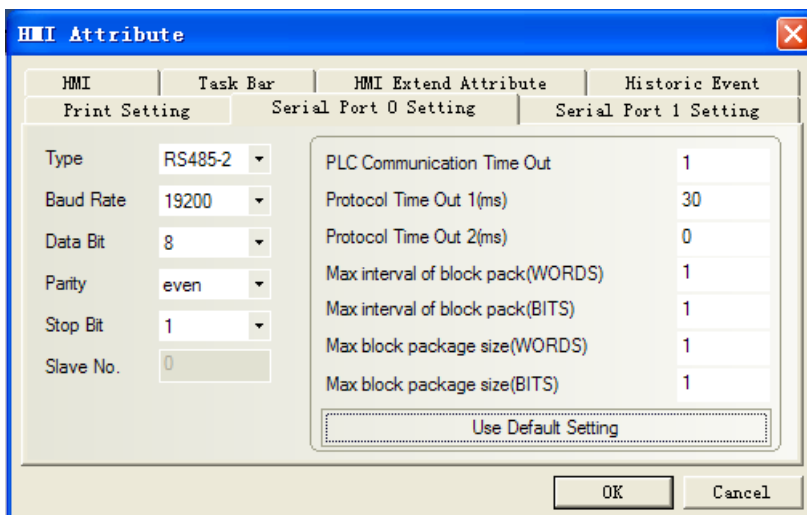

**NOTE:** To communicate with the touch screen, declare variable firstly in the Rexroth software.

### L40 communication settings

Default communication: 38400, 8, 1, none; Station No.: 2

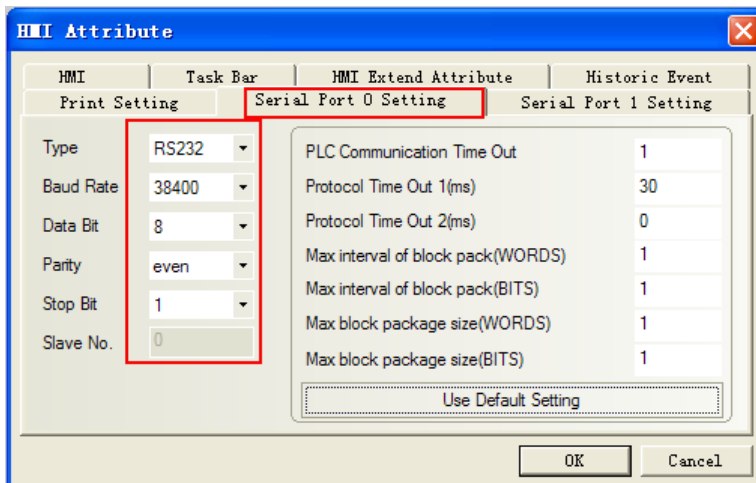

**NOTE:** To communicate with the touch screen, declare variable firstly in the Rexroth software.

### L40 Hardware Settings

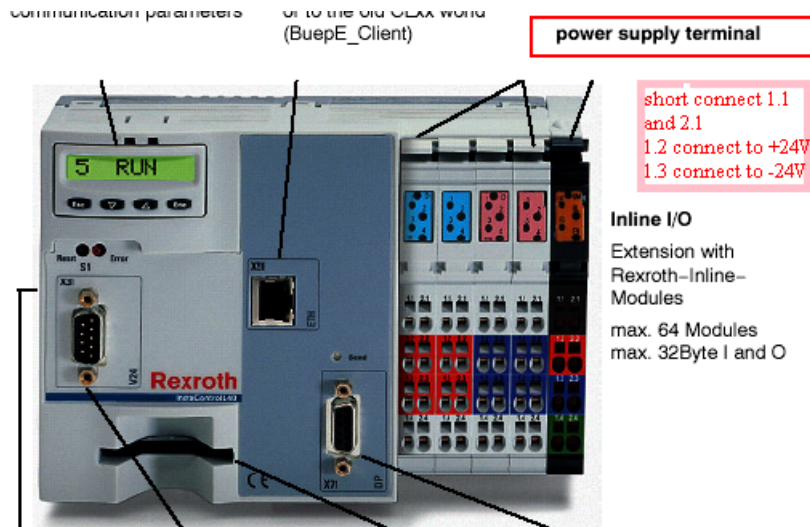

### PLC Setting

#### PPC-R software setting

PLC connects with PC via crossover ethernet cable. If using cross-connection ethernet cable, you must add a HUB (we usually use a cross-connection line to access the Internet)

Hardware configuration:

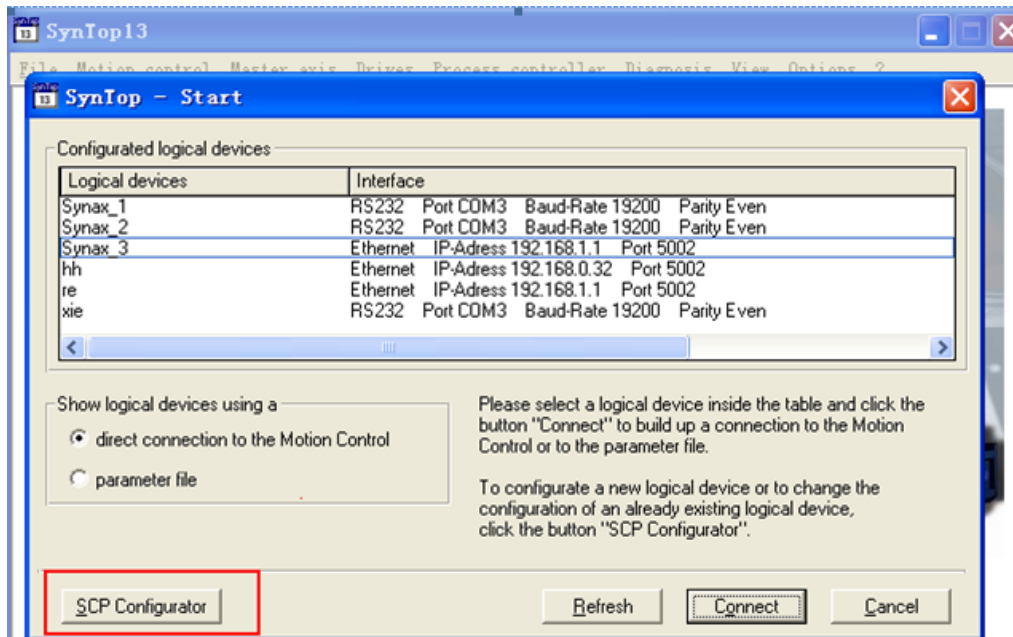

1. Click "scp configurator" ---> "scanning "or" add device" ---> "next", pay attention to the default controller IP: 192.168.1.1. And set IP 192.168.1.1 in the software (**PC and controller must be set up in the same segment**), ping IP address is OK, that configuration is successful. Save and close "scp configurator" ---> "refresh" to see logical devices created in configured logical devices", double-click to enter. All configurations will be successful.

2. Open "indralogic" ---> **online/communication parameter** ---> "new" and select "TCP/IP" to modify "value", set IP address the same as controller: 192.168.1.1

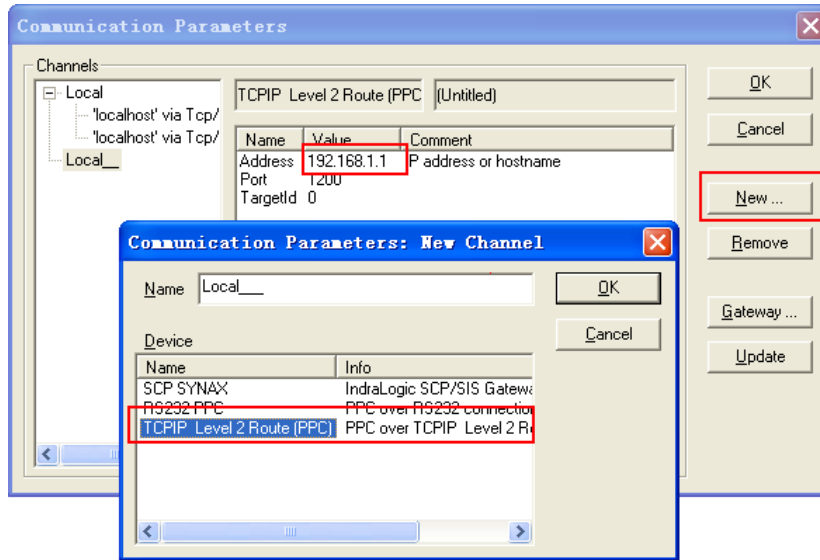

3. "Resource"---->"Global variables"---->declare variable in "HMI"

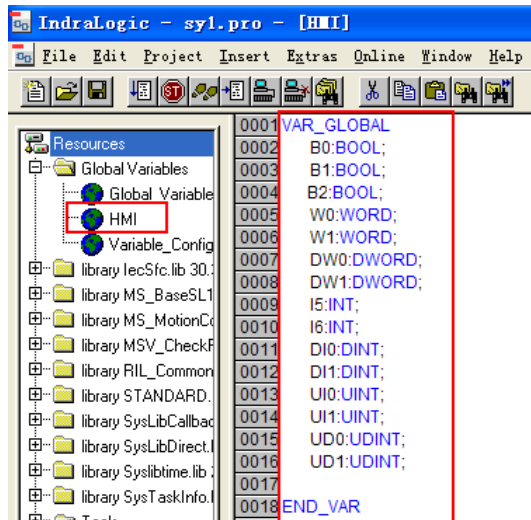

4. Click "online/login"

### L40 software setting

1) The IndraLogic software connect with the Rexroth IndraControl L40 by ethernet cable (test: plc IP address: 192.168.100.103)

Open the IndraLogic software, create a new project:

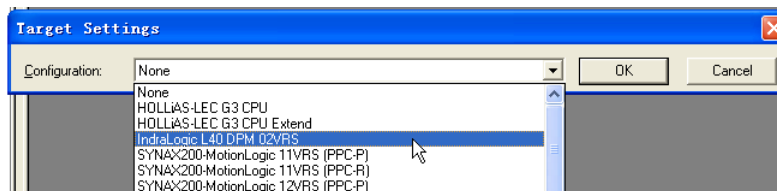

Click "OK" and pop-up the window as follows:

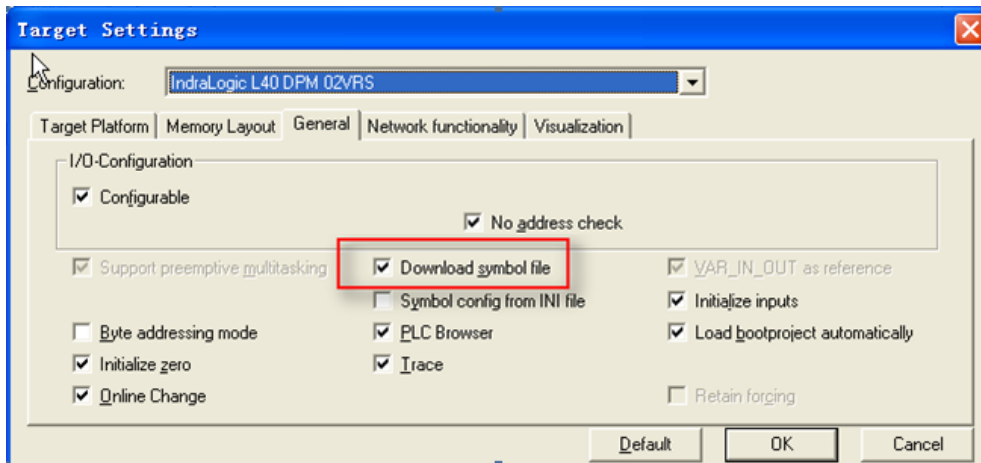
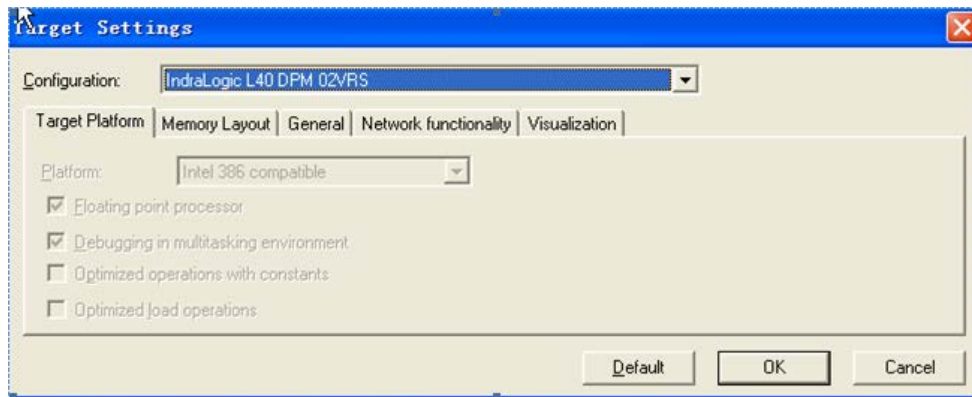

**NOTE:** Must select Download symbol file  
Click "OK" and pop-up the window as follows:

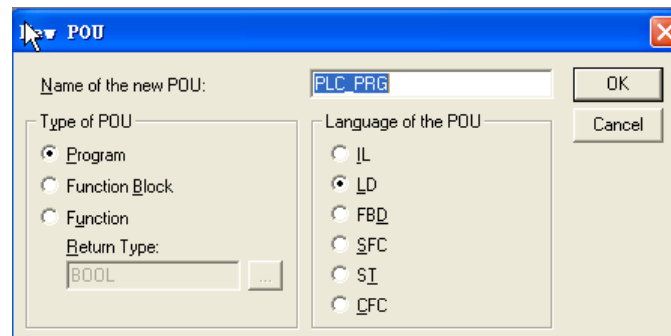

And then edit program:

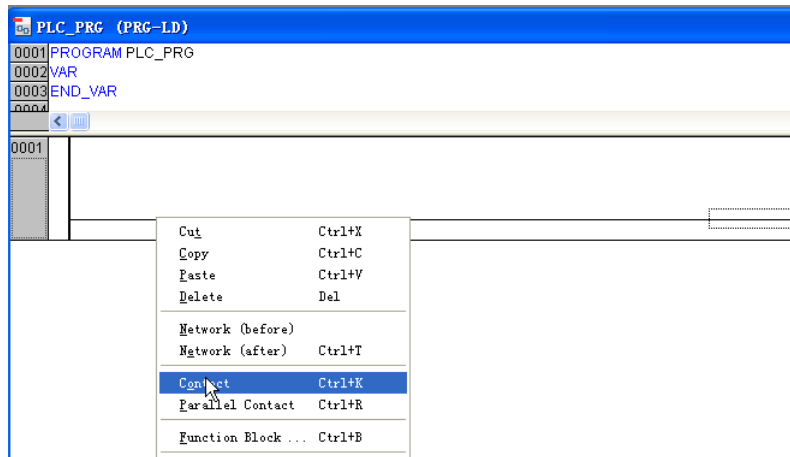

Input B0 and pop-up the dialog, configurations as follows, click "OK":

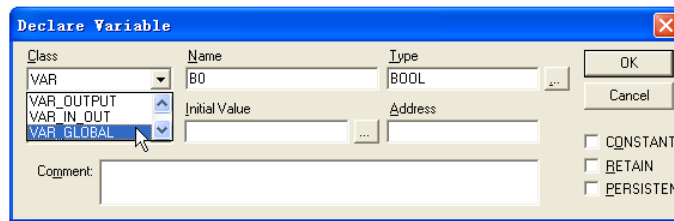

And set up coil:

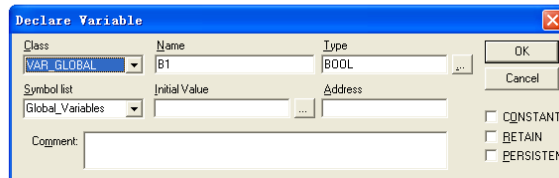
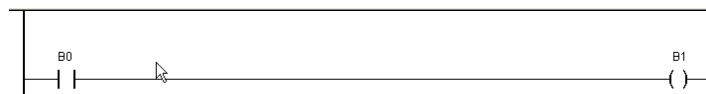

At the same time, you will find that there automatically generate two variables in the global variable:

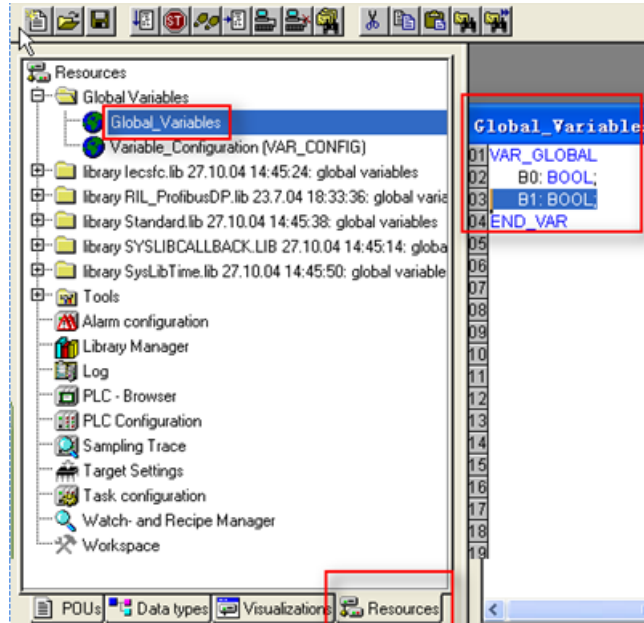

Then setting as follows:

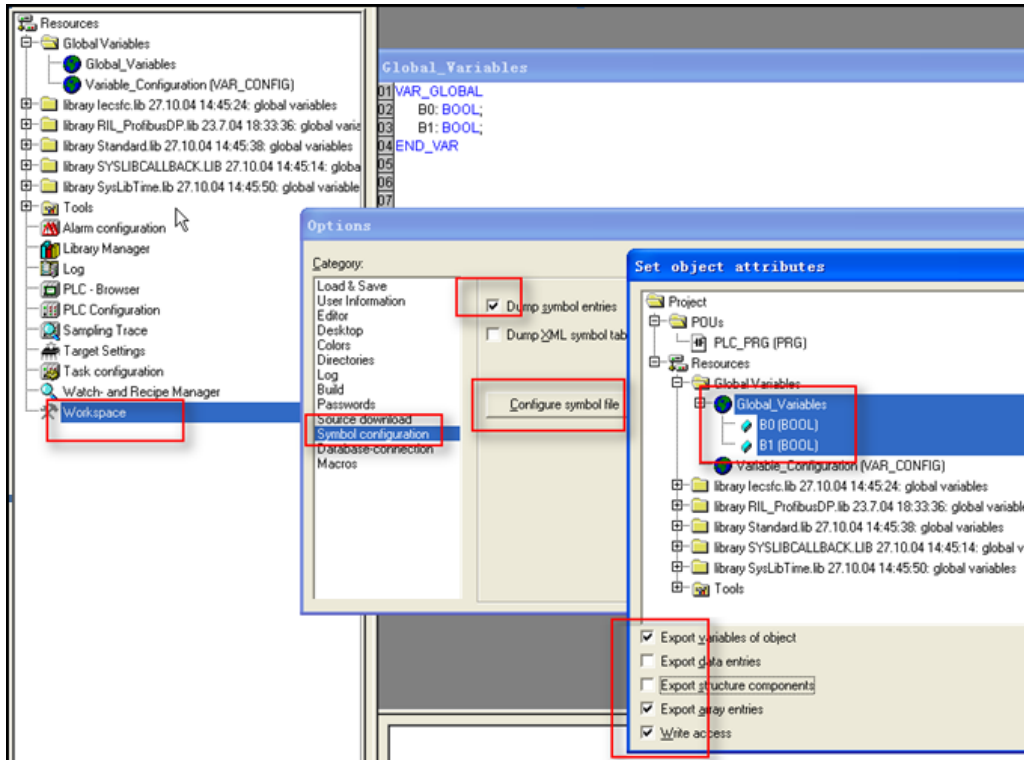

Setting communication parameter:



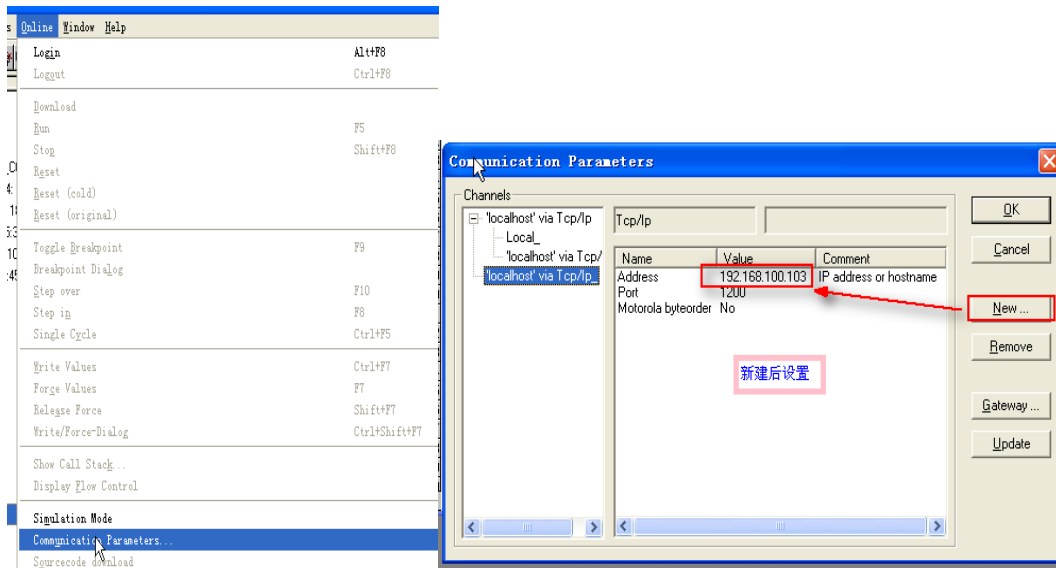

Then click "Login":

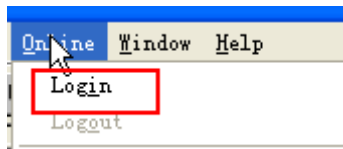

Communicating successfully, you can operate ("Online" menu to select "run" or others) :

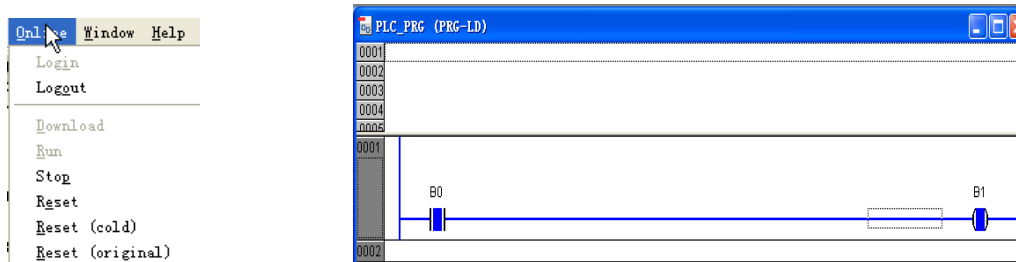

**NOTE:** The PLC panel must be set up, press "Enter", then press " " until B52, and then press "Enter" to enter "COM SERV" interfaces (not SERV, it must change to SERV)



In accordance with the above settings, the serial line access, EV5000 can be communicated with the Rexroth Controller L40 by serial port.

### IndraDrive C

#### HMI setting

HMI default communication parameters: 9600bps, 8, parity check, 1; PLC station number: 0

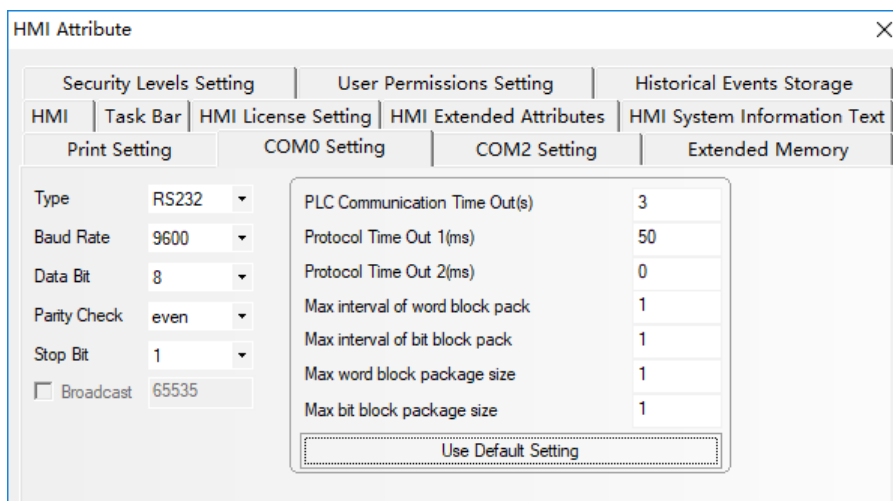

### ◎ Supported Device

Device	Bit Address	Word Address	Format	Notes
BYTE	B0000-9999	-----	DDDD	
WORD	-----	W0-65535	DDDDD	
INT	-----	I0-65535	DDDDD	
UINT	-----	UI0-65535	DDDDD	
DWORD	-----	DW0-65535	DDDDD	
DINT	-----	DI0-65535	DDDDD	
UDINT	-----	UD0-65535	DDDDD	

### IndraDrive C

Device	Bit Address	Word Address	Format
S40	-----	S40 0	D
S51	-----	S51 0	D
S84	-----	S84 0	D
S430	-----	S430 0.00	D.HH
P1311	-----	P1311 0	D
P1312	-----	P1312 0	D
P1370	-----	P1370 0-15	DD

### ◎ Cable Diagram

#### PPC-R RS232 communication cable

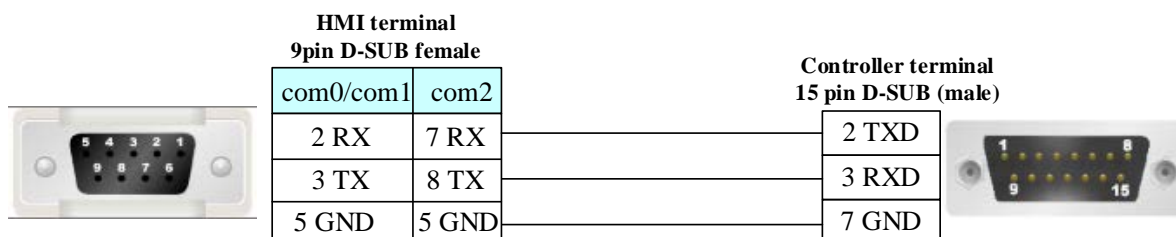

### PPC-R RS485 communication cable

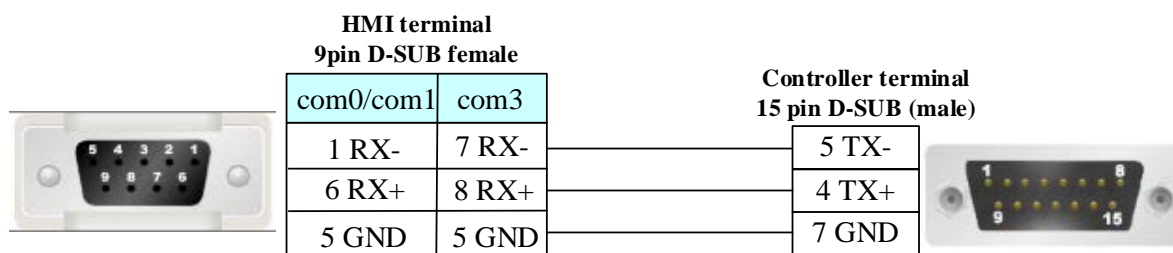

### L40 communication cable

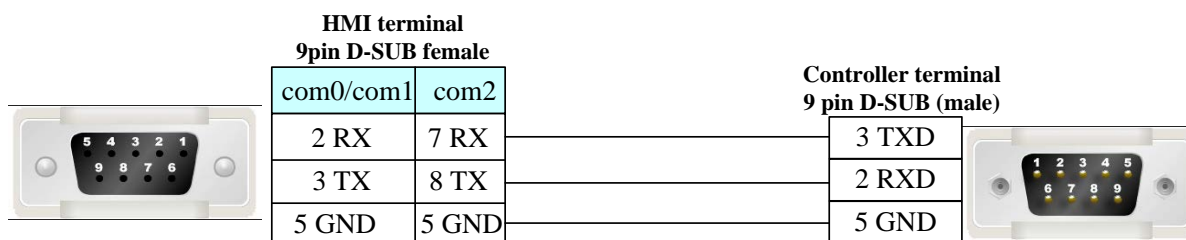

### IndraDrive C

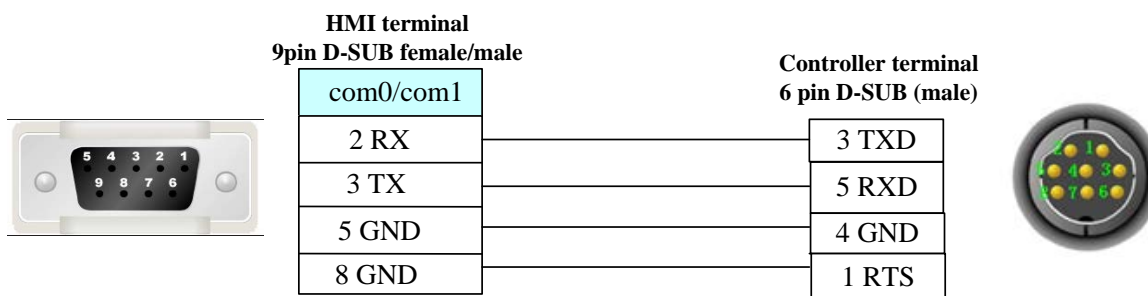

## 4.13 Bosch Rexroth Ethernet

© **Network communication** (indirect online and direct online simulation disable)

Series	CPU	Link Module	Driver
IndraLogic	IndraLogic L40 DPM	ETH on the CPU unit	Bosch Rexroth Ethernet
IndraMotion MLC	IndraControl L25	ETH on the CPU unit	Bosch Rexroth L25 Ethernet

© **System configuration**

Series	CPU	Link Module	COMM Type	Parameter	Cable
IndraLogic	L40 DPM 02VRS	ETH on the CPU unit	ETH	<a href="#">Setting_</a>	<a href="#">Your owner cable</a>
IndraMotion MLC	IndraControl L25	ETH on the CPU unit	ETH	<a href="#">Setting_</a>	<a href="#">Your owner cable</a>

© **Communication Setting**

### L40

#### HMI Setting

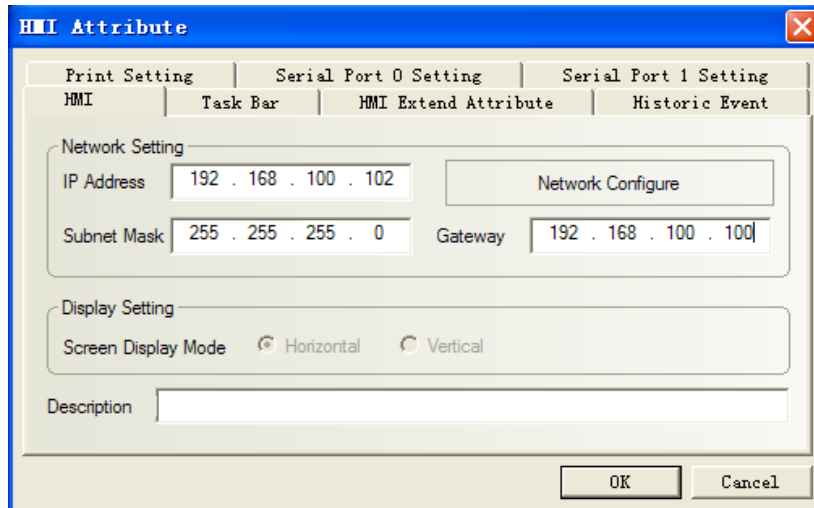
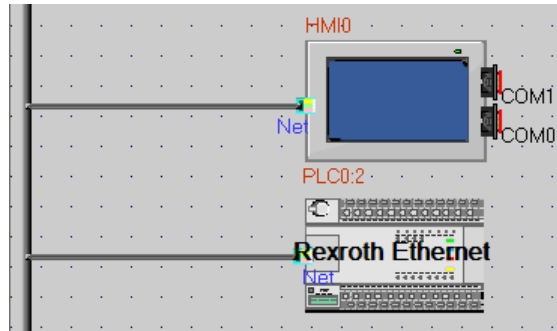

※PLCAttribute (station disable)

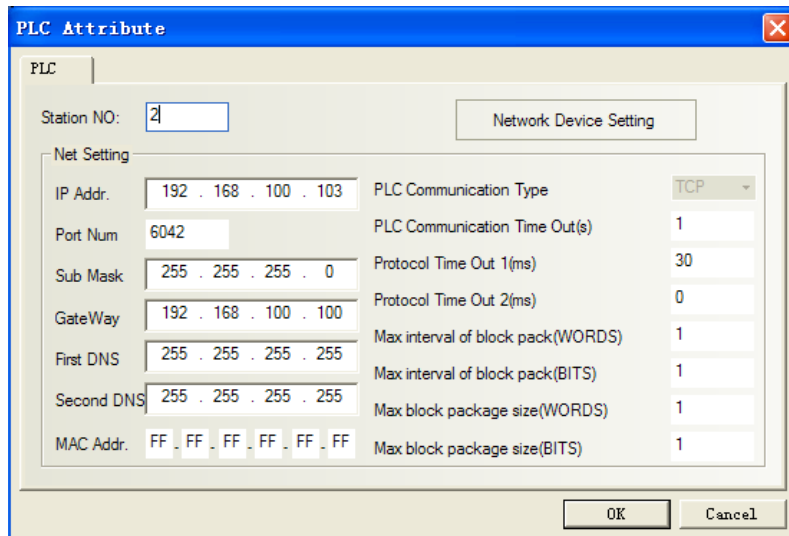

※Network configuration (Note: PLC port num. must be set 6042, HMI port num. is optional, default is 6042. In addition, the screen and plc must be set in the same network segment, the gateway of the screen is better to set with the actual use of the network gateway.)

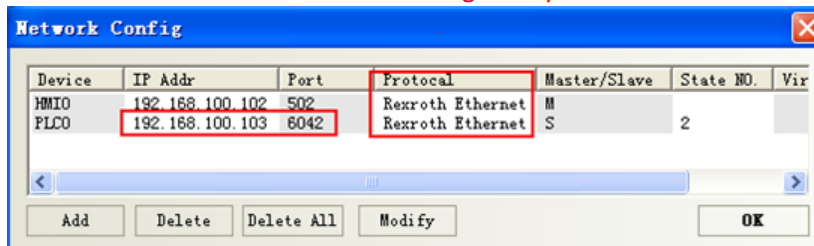

**NOTE:** To communicate with the touch screen, declare variable firstly in the Rexroth software.

**PLC Setting**

PLC connect with PC by crossover network cable, if using cross-connection network cable, you must add a HUB (we usually use a cross-connection line to access the Internet)

1. After L40 equipped with software driver successfully, to set as follows:

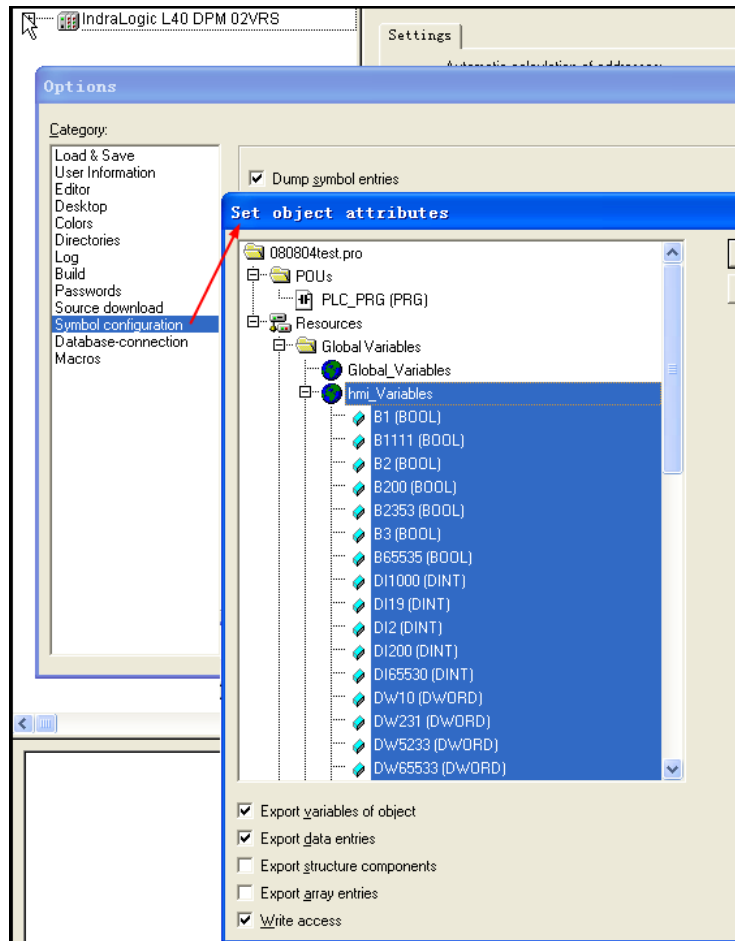
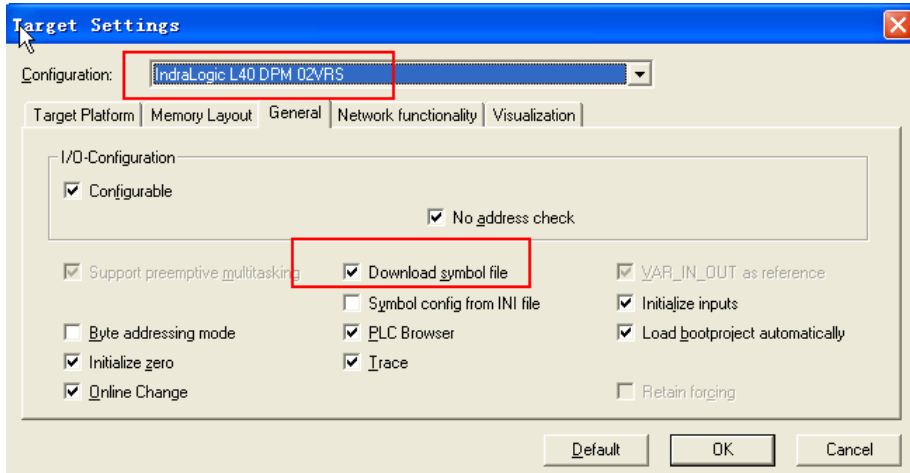

At this time open "indralogic" -->"online/communication parameter" -->"new" and select "TCP/IP " to modify "value", set IP address the same as controller: 192.168.100.103

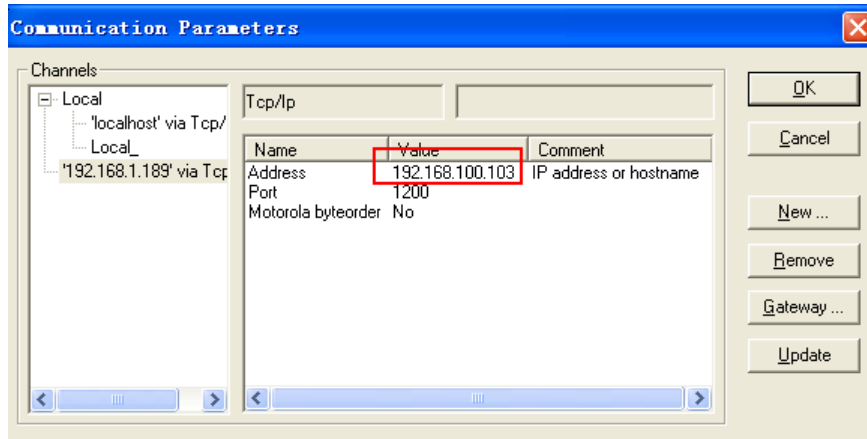

2. "Resource"---->"Global variables"---->declare variable in "HMI"

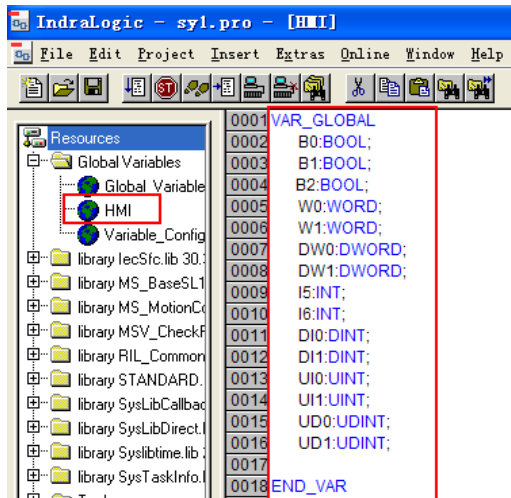

3. Click "online/login"

## L25: HMI Setting

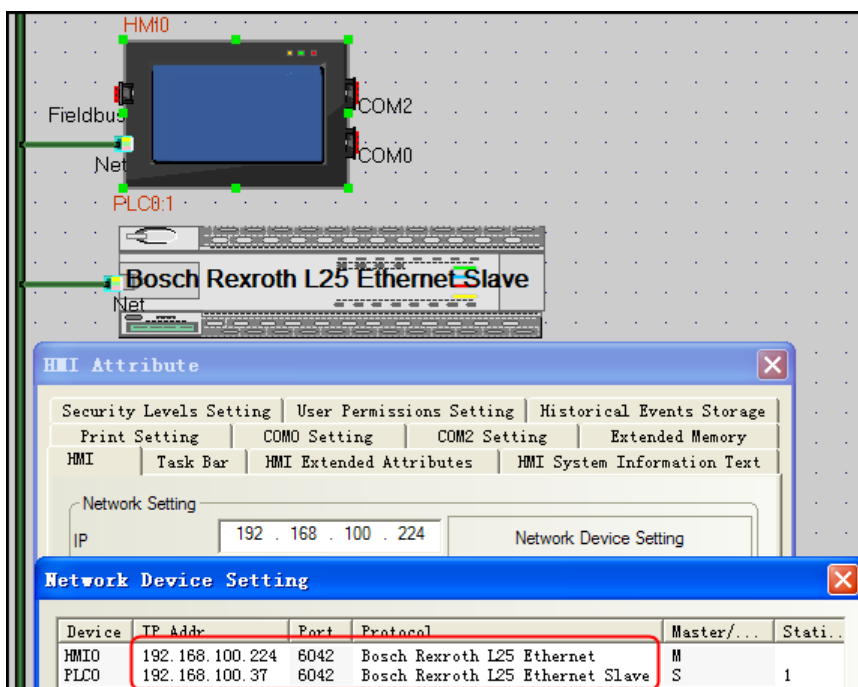

## PLC Setting

1. Modify the IP in the controller.
2. Declare variable in controller programmer software.
3. Software setting
  - 1) Create new project and select IndraMotion MLC L25 (library→driver and control→IndraMotion MLC), then drag the selected controller onto the project file.

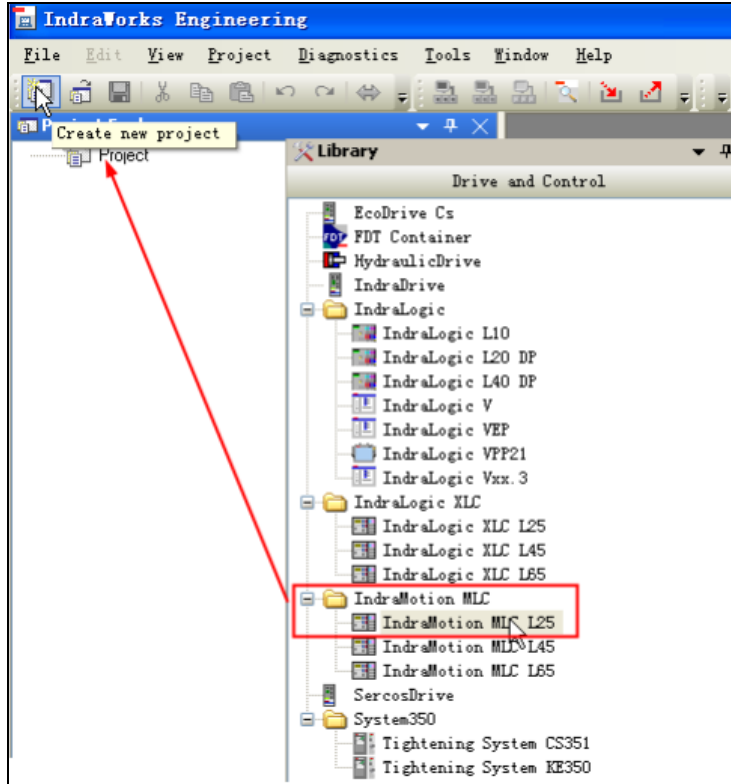

- 2) IN Insert IndraMotion MLC L25 properties box, set the Firmware release (FWA-CML25\*-ML\*-12V06) and IP address.

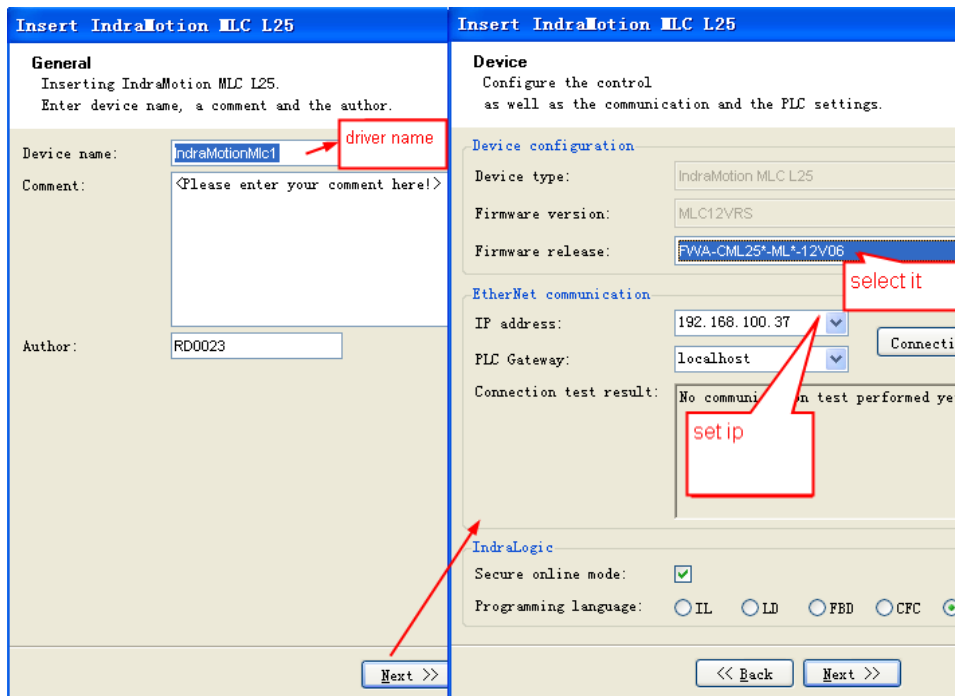

3) Declare variable

Declare variable UD in [Application]→[PlcProg(PRG)],and declare the variable type.

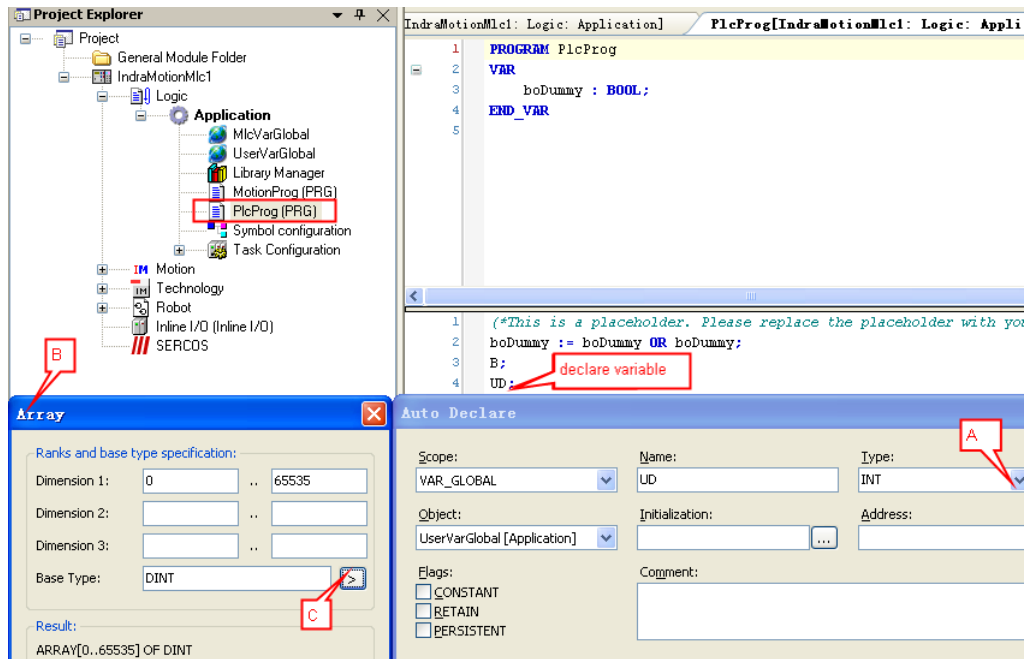

4) View the Declared variable in [Application]→[UserVarGlobal]

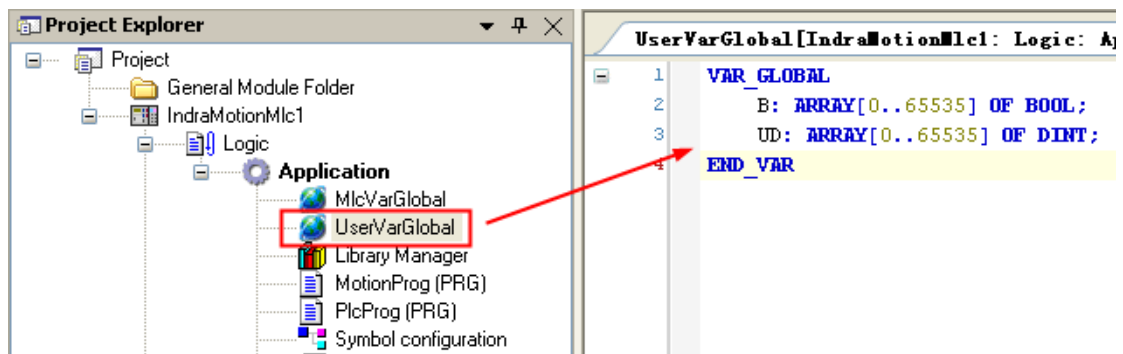

4. Click “online/login”

◎ Supported Device

Device	Bit Address	Word Address	Format	Notes
BYTE	B0000-9999	-----	DDDD	
WORD	-----	W0-65535	DDDDD	
INT	-----	I0-65535	DDDDD	
UINT	-----	UI0-65535	DDDDD	
DWORD	-----	DW0-65535	DDDDD	
DINT	-----	DI0-65535	DDDDD	
UDINT	-----	UD0-65535	DDDDD	

◎ Cable Diagram

Cross-connection or crossover network cable can be used as communication cable via the hub

Refer to [3.3 Download by Network Ethernet](#) for method of making connection cable.



## 4.14 CANOpen Node Slave

### ◎ Serial Communication

Series	CPU	Link Module	Driver
KINCO	K4	CAN port on the External Device	CANOpen Node Slave
Other company devices which support CANOpen		CANOpen port	

### ◎ System configuration

Series	CPU	Link Module	Parameter	Cable
KINCO	K4	CAN port on the External Device	<a href="#">Setting</a>	<a href="#">Your owner cable</a>
Other company devices which support CANOpen		CAN port	<a href="#">Setting</a>	

### ◎ Communication Setting

#### HMI Setting

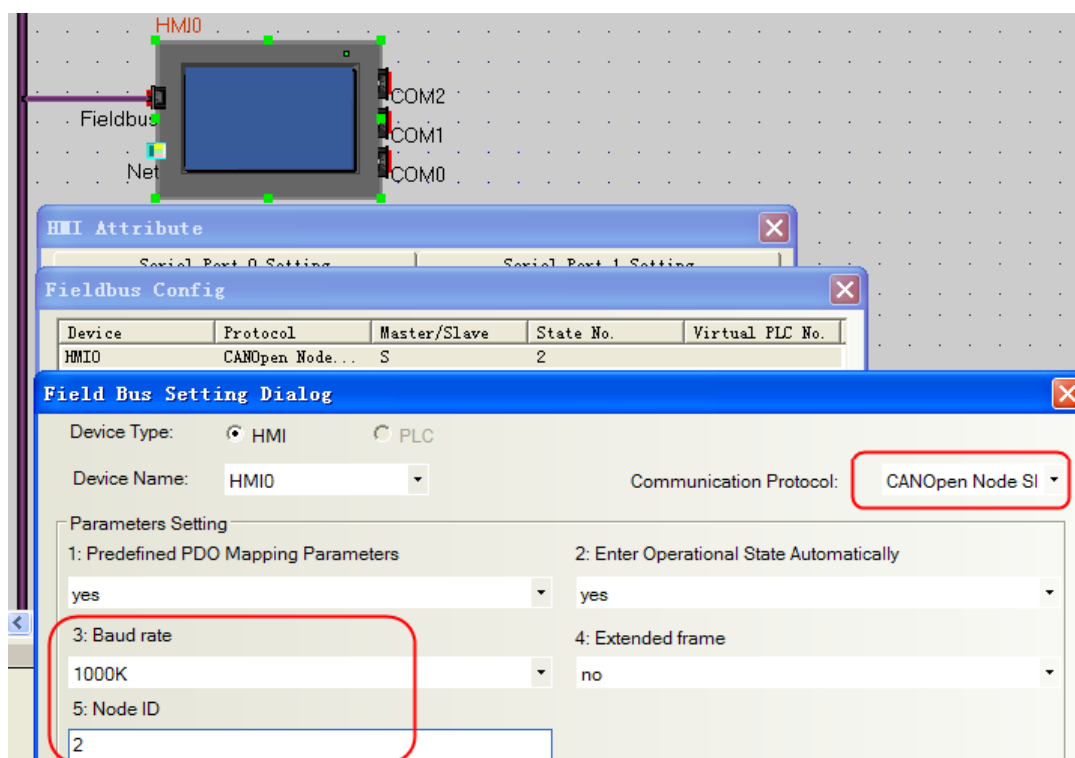

**NOTE:** Baud Rate and Station No. must be the same as the setting in the controller.

#### Parameters Setting

##### 1. Predefined PDO mapping parameters

a. Default is “yes”, that is an effective predefined PDO mapping parameters. HMI now use the following PDO communication parameters and mapping

**Receive PDO Mapping**

**Send PDO Mapping**

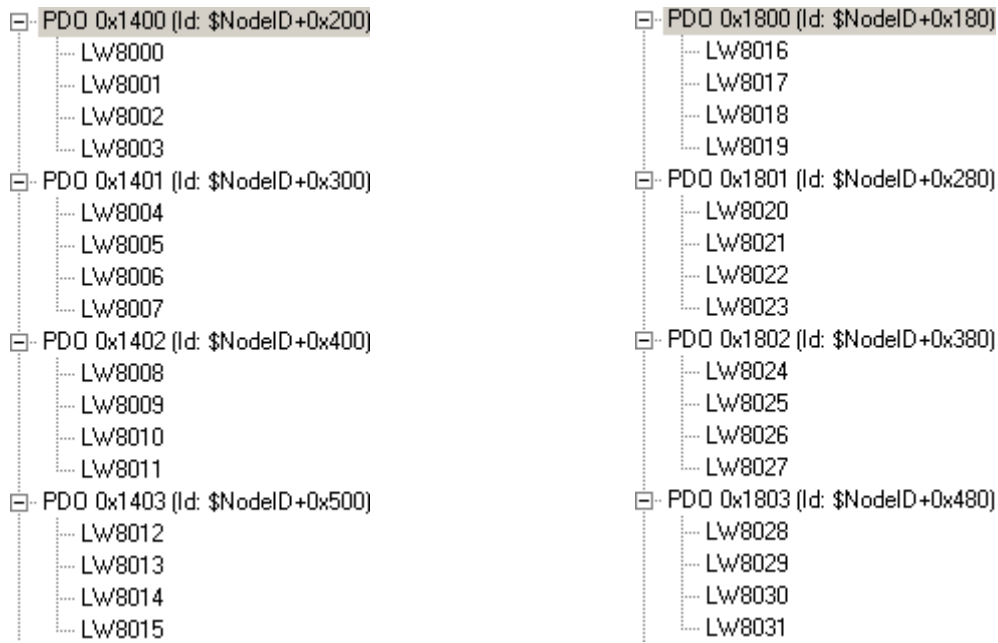

**Note:** TX\_PDO using the event-triggered mode, that is, only when its mapping variable changes, it sends the PDO.

b. If the "No", the main station or other equipment necessary to configure the PDO communication parameters and mapping (configure only in the pre-operational status). After configured, you can send a save command via USB-CAN or controller to save the current configuration (restart still valid).

Command:

	COB-ID	DATA
Save the configuration information:	0x600 + NodeID	0x23 0x10 0x10 0x01 0x73 0x61 0x76 0x65
Restore to factory defaults:	0x600 + NodeID	0x23 0x11 0x10 0x01 0x6C 0x6F 0x61 0x64
Into the operating state:	0x00	0x01 NodeID
Into the pre-operational status:	0x00	0x80 NodeID

2. Enter operational state automatically

a. Default is "yes", that is, HMI enter the operational status (OPERATIONAL) automatically after power-up, NMT Master is no need to re-send start instructions.

b. If the "No", then HMI enter the pre-operational status (PRE-OPERATIONAL) automatically after power-up, only when the NMT Master sends start commands, system can entering the operational status (OPERATIONAL)

**Note:** PDO is effective only in the operating conditions (OPERATIONAL).

3. Baudrate

CAN port baud rate must be the same as CAN bus.

4. Node ID

HMI in the CAN bus ID, the ID only for the use of CANopen protocol. When using all the PDO (RX\_PDO1 ~ RX\_PDO64, TX\_PDO1 ~ TX\_PDO64), station number can not exceed 7, the bus station number of other devices also can not exceed 7.

**PLC setting**

**Note:** you can find MT5020.EDS in fieldbus file of EV5000 Installation Directory, or you can download from

[www.kinco.cn](http://www.kinco.cn).

Take MT6000 for example (we use MT6000 HMI to test, and use 3S CODESYS software to download project)

1. Setup

- Start Menu “3s Software”->“Codesys v2.3”->“installtarget”

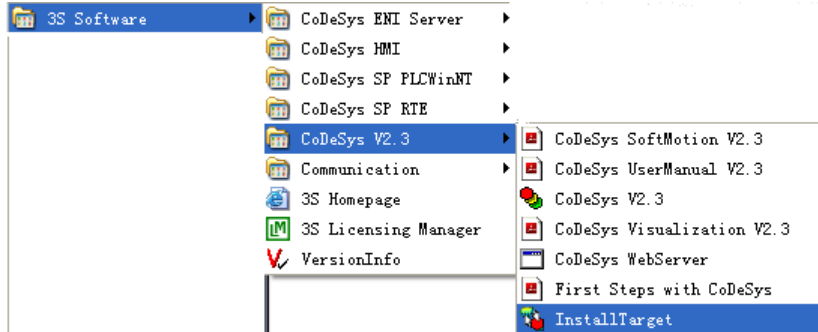

- Click “open” choose “StepServoARM.tnf”, and then click “install”.

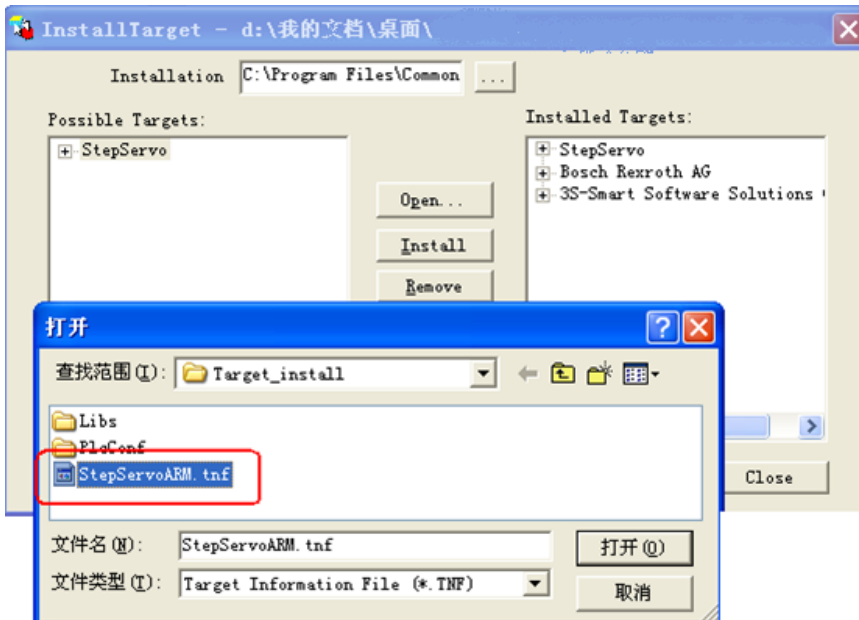

2. Copy “MT5020.EDS” to “C:\Program Files\Common Files\CAA -Targets\ StepServo\ PlcConf”

3. Configuration setting

- a. run codesys software, make a new project

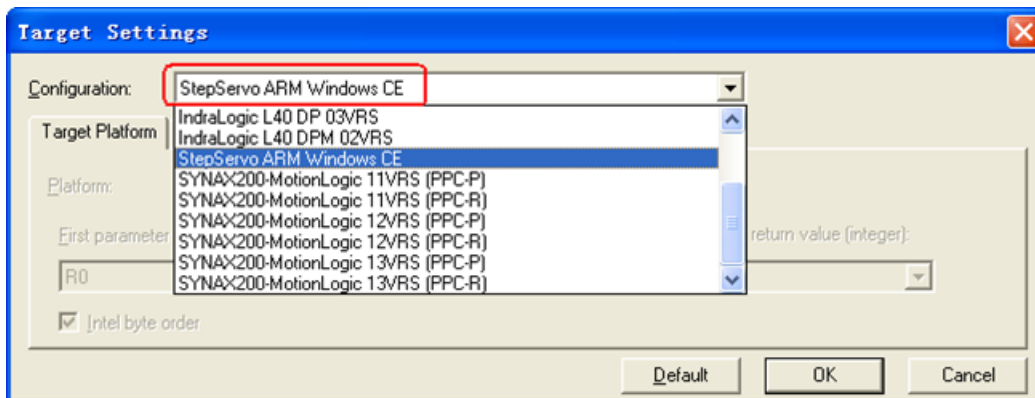

- b. configuration setting, right click “PLC configuration” and choose “CanMaster”

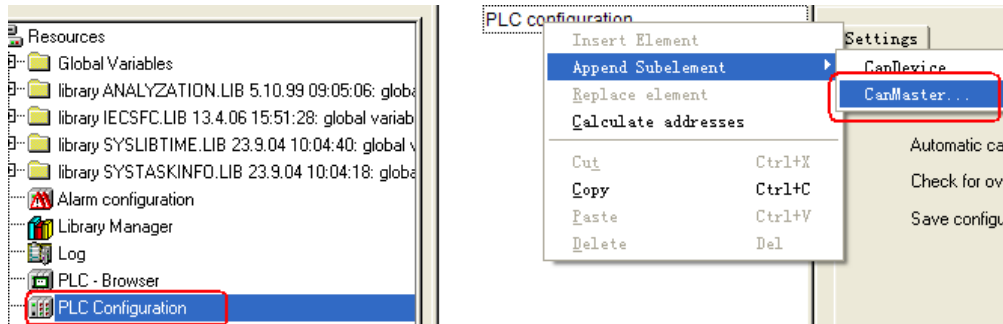

c. set Baud Rate

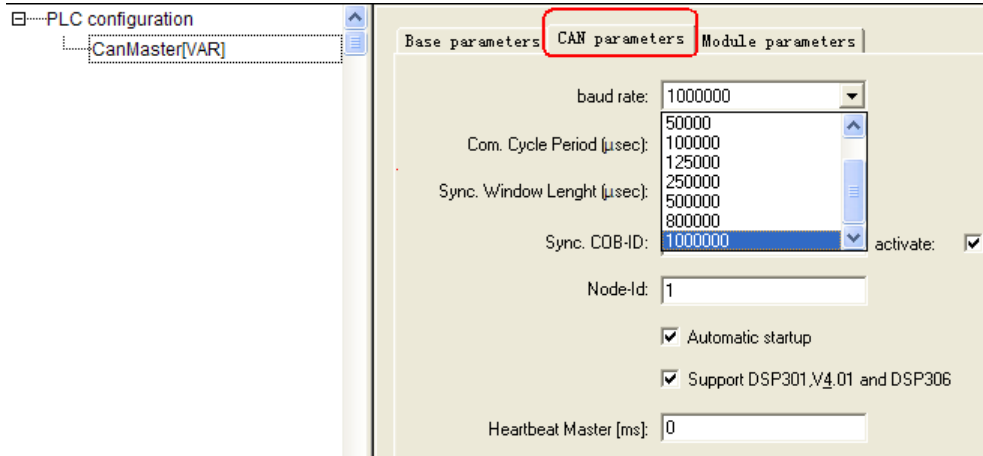

d. choose "CanMaster" right click "Append HMI-MT5020"

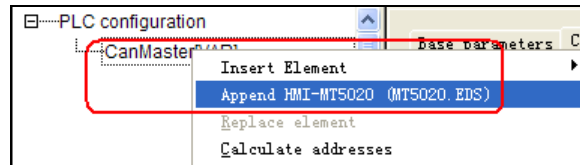

e. Node ID: set slave station No.

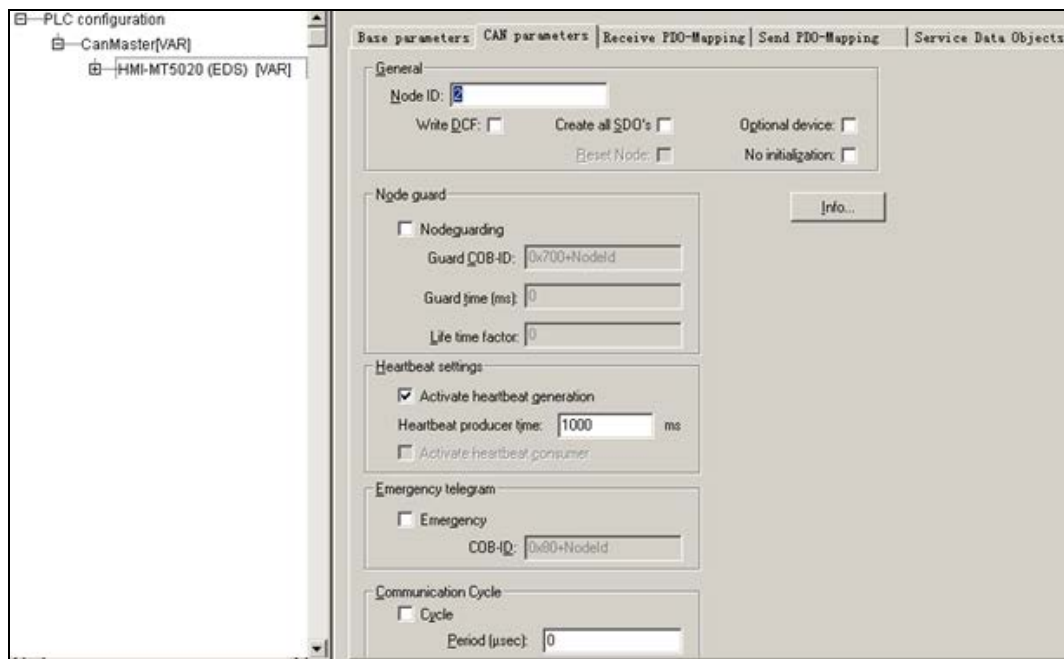

f. in the "Library Manager" we import "3S\_CANopenMaster.lib"

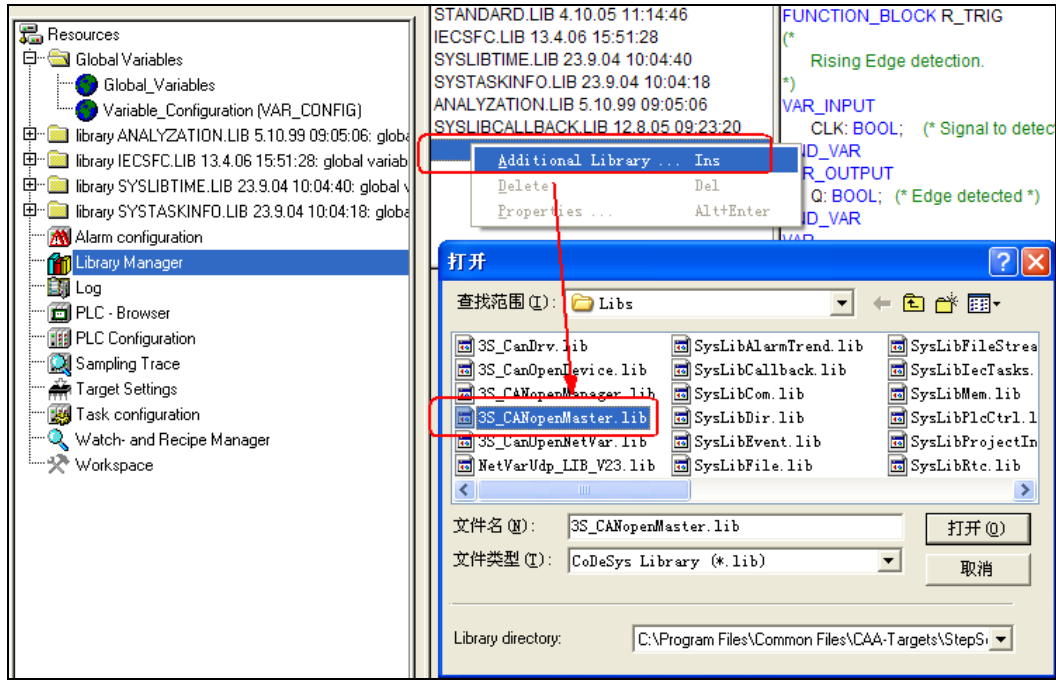

g. PDO read and write setting

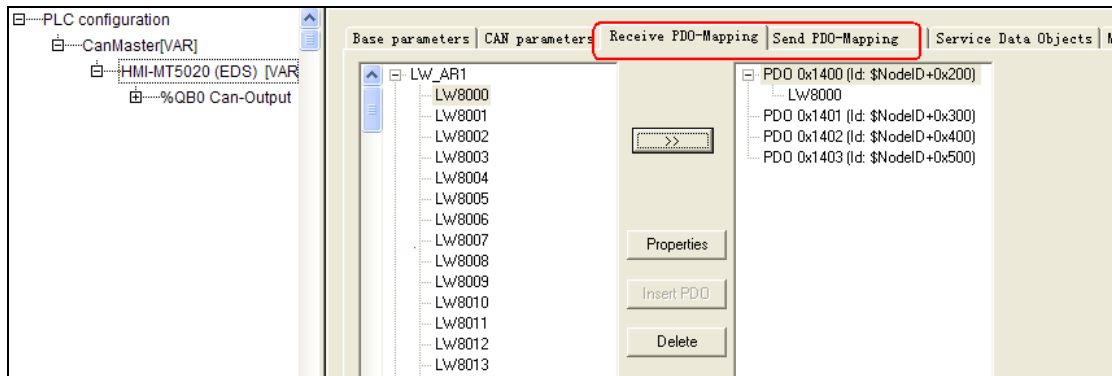

h. define Global Variable

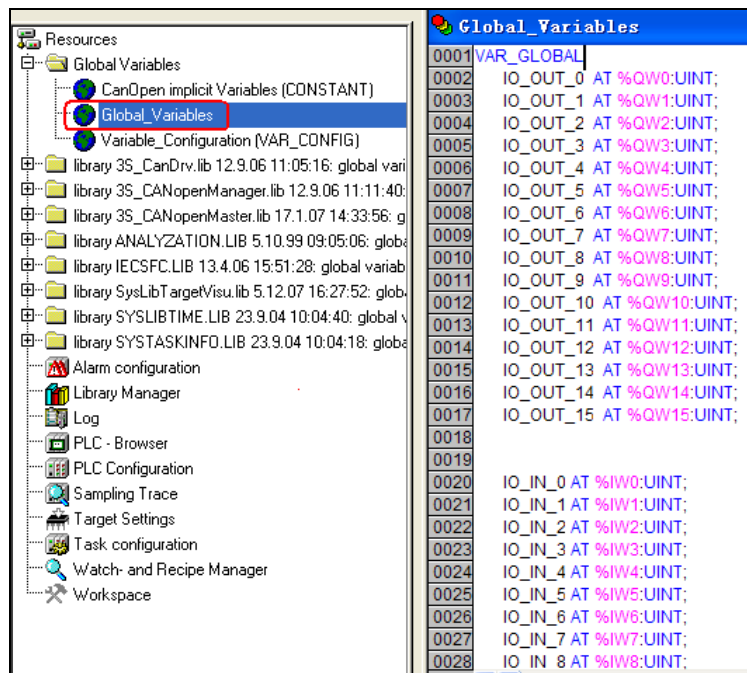

i. SDO setting, this step need program

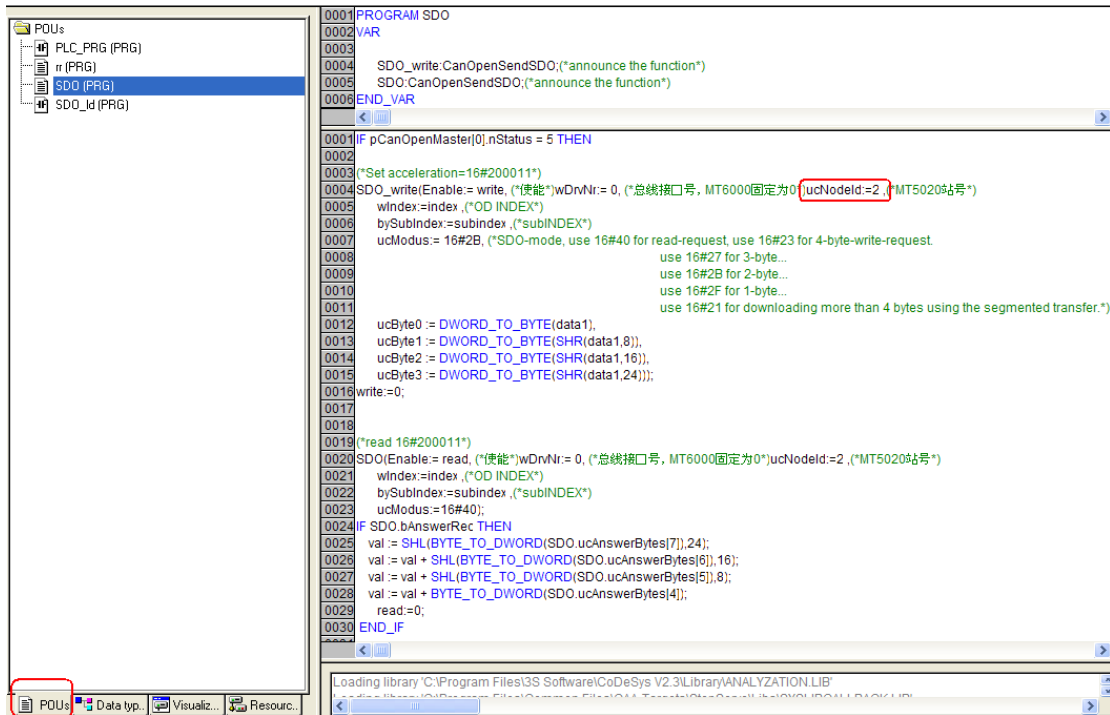

j. load the configuration into the PLC



### ◎ Supported Device

Device	Bit Address	Word Address	Format	Notes
	-----	LW8000~LW8999	DDDD	

**NOTE:** We must make the setting of PDO, SDO and LW the same as codesys

### ◎ Cable Diagram

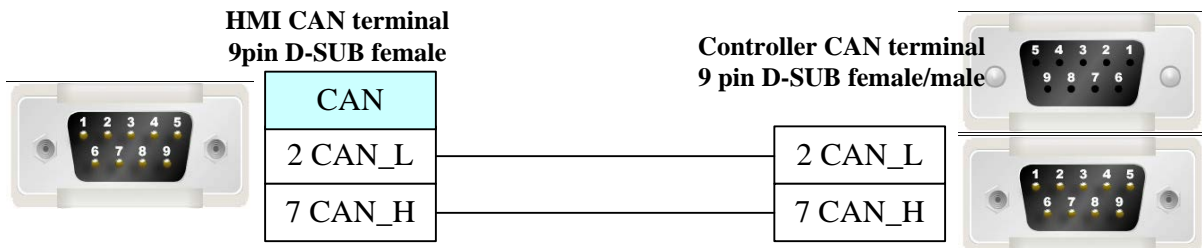

## 4.15 Cimon

### ◎ Serial Communication

Series	CPU	Link Module	Driver
PLC-S	Cimon CM3-SP16MDRV	RS232 on the CPU unit	<a href="#">Cimon CM3-SP16</a>

## ◎ System configuration

Series	CPU	Link Module	COMM Type	Parameter	Cable
PLC-S	Cimon CM3-SP16MDRV	RS232 on the CPU unit	RS232/RS485	<a href="#">Setting</a>	<a href="#">Your owner cable</a>

## ◎ Communication Setting

### HMI setting

Default parameter: 9600bps, 8, none, 1; station number: 0

### RS232

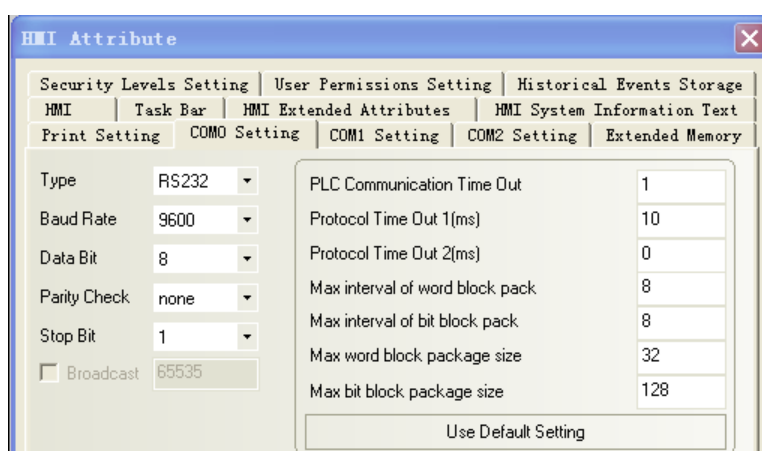

### RS485

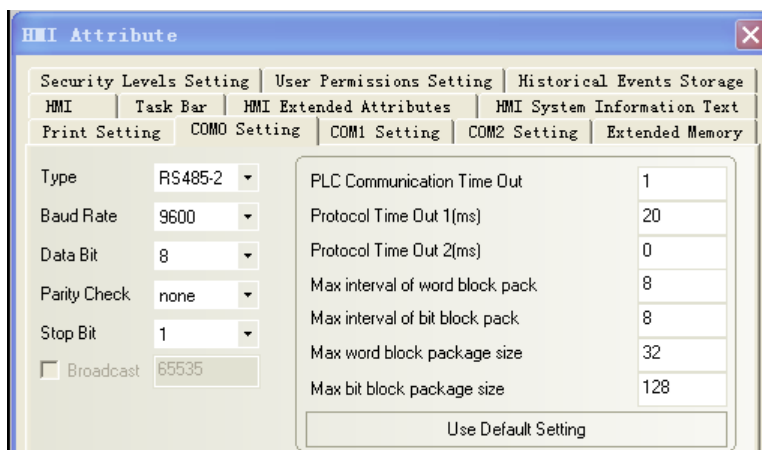

## ◎ Supported Device

Device	Bit Address	Word Address	Format	Notes
Input	X 0.0-63.F	-----	DD.F	
Output	Y 0.0-63.F	-----	DD.F	
Sub Relay	M 0.0-511.F	-----	DDD.F	
Link Relay	L 0.0-255.F	-----	DDD.F	
Keep Relay	K 0.0-255.F	-----	DDD.F	

Timer	T 0-519	-----	DDD	
Counter	C 0-519	-----	DDD	
Special Relay	F 0-2047	-----	DDDD	
Z Register	-----	Z 0-1029	DDDD	
Timer	-----	T 0-519	DDD	
Counter	-----	C 0-519	DDD	
Data Device	-----	D 0-9999	DDDD	
Sub Relay	-----	M 0-511	DDD	
Output	-----	Y 0-63	DD	
Input	-----	X 0-63	DD	
Keep Relay	-----	K 0-255	DDD	
Link Relay	-----	L 0-255	DDD	
Step Control Relay	-----	S 0-99	DD	

◎ Cable Diagram

RS232

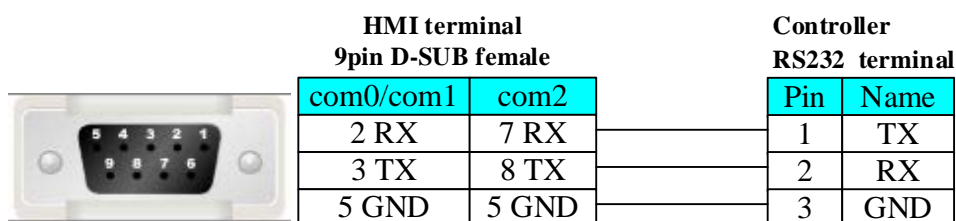

RS485

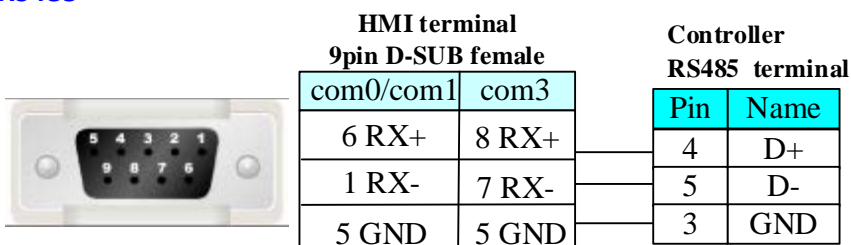

4.16 Danfoss Inverter

◎ Serial Communication

Series	CPU	Link Module	Driver
Danfoss	FC-300	RS485 on the CPU unit	Danfoss Modbus RTU

◎ System configuration

Series	CPU	Link Module	COMM Type	Parameter	Cable
--------	-----	-------------	-----------	-----------	-------



Danfoss	FC-300	RS485 on the CPU unit	RS485	<a href="#">Setting</a>	<a href="#">Your owner cable</a>
Modbus RTU	FC-300	RS485 on the CPU unit	RS485	<a href="#">Setting</a>	<a href="#">Your owner cable</a>

## ◎ Communication Setting

### Danfoss Protocol:

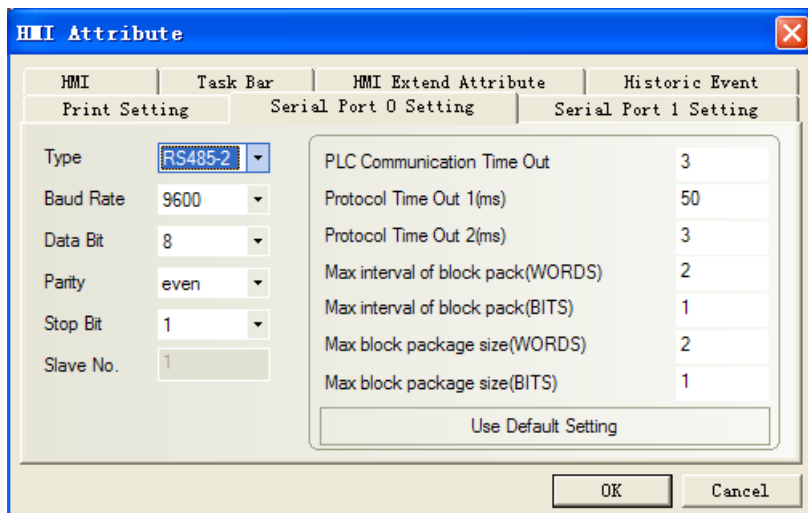

### Modbus RTU Protocol:

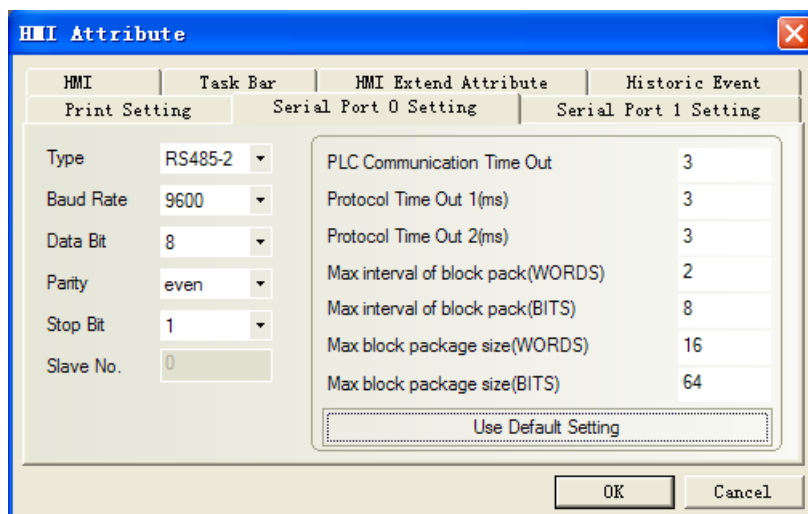

**Note:** Change the value of 8-30 to 2 on the Danfoss inverter for modbus protocol (Change the value of 8-30 to 0 for the Danfoss Protocol)

## Inverter

8-3\* FC Port Setting

8-30 protocol

\*[0] FC (danfoss protocol)

[2] Modbus (modbus protocol)

8-31 address

1 – 247 \* 1 (HMI station No.)

8-32 FC Port Baud Rate

- [0] 2400 Baud
- [1] 4800 Baud
- \*[2] 9600 Baud

8-33 FC Port Parity

- \*[0] even, 1 stop bit
- [1] Odd, 1 stop bit
- [2] None, 1 stop bit
- [3] None, 2 stop bit

### Inverter setting

Please refer to the manual of Danfoss inverter for details

### ☉ Supported Device

#### Danfoss Protocol:

Device	Bit Address	Word Address	Format
EEPROM Register(Double Word)	-----	EPD0-7998.99999	DDDD.DDDDD
EEPROM Register	-----	EPW0-7998.99999	DDDD.DDDDD
RAM Register(Double Word)	-----	RMD0-7998.99999	DDDD.DDDDD
RAM Register	-----	RMW0-7998.99999	DDDD.DDDDD

**Note:**

1. D indicates decimal; the prefix of RMD\RMW\EPD\EPW is address parameter, the suffix is index number.

2. Mapping of index address (adding radix point if having index address, index value follow radix point. Otherwise there's no radix point):

RMW310.1 is to 3-10, please clicking Menu, to find 3-10 to check.

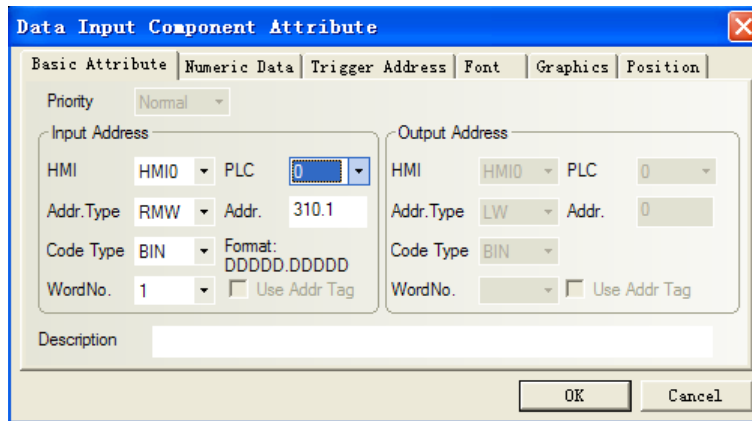

3. If no index, radix point followed by default zero. As follows RMW122 to 1-22:

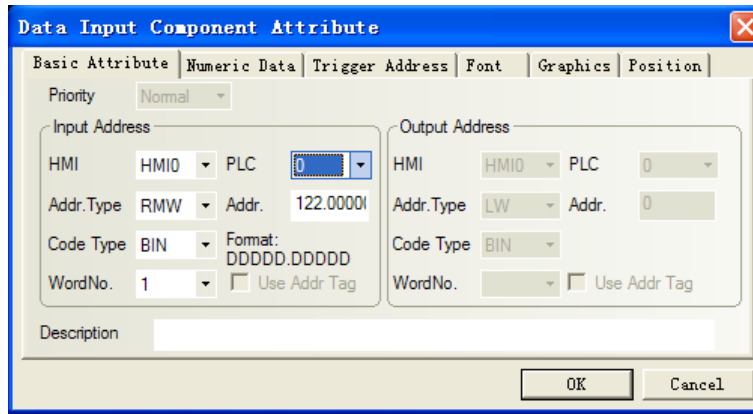

4. R/W of process word:

- 1) Address of EPD register is 8000, is for saving input command value of process word;
- 2) Address of EPD register is 8100, is for saving return value of process word;
- 3) Input command value and return value can be showed by RW register.
- 4) Start\Stop, Mapping of reference value to frequency:

Reason: RWD8000 is for inputting control word, it's not able to input control word by itself, but via sending RW1, RW0 to RWD8000 by timer.

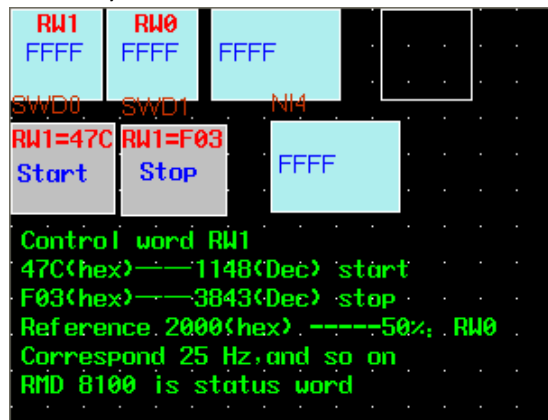

◆ Control word RW 1: While RW 1=0x47C or 1148, it means start. While RW=0x0F03 or 3843, it means stop.

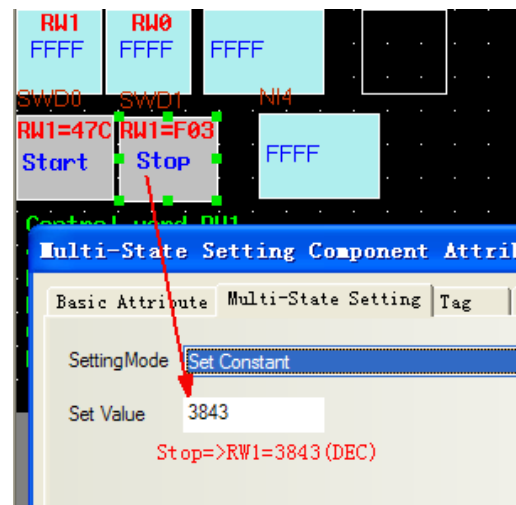
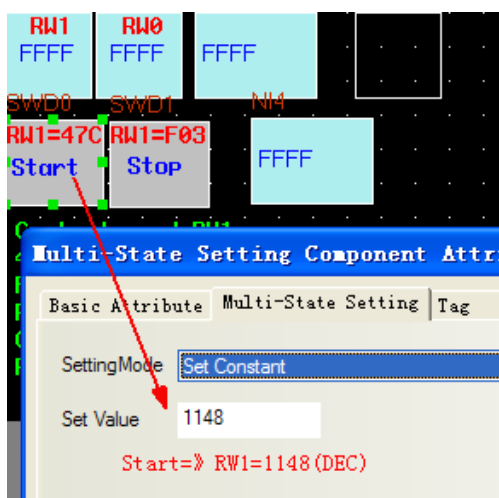

◆ Frequency of RW0 mapping : If input 2000 to RW0, frequency is 25HZ, and input 4000, frequency is 50HZ, and so on.

◆Timer, send value of RW 1 and RW 0 to RW D8000.

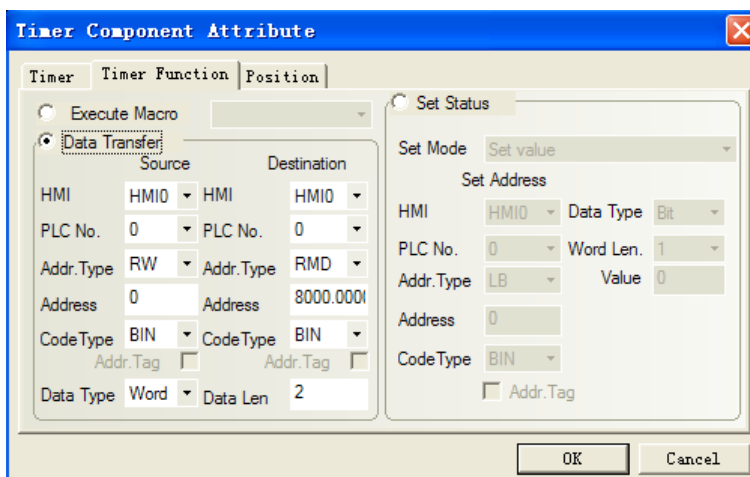

**Modbus RTU Protocol:**

Device	Bit Address	Word Address	Format	Notes
Output bit	0X1-65535	-----	DDDDD	
Input bit (read only)	1X1-65535	-----	DDDDD	
Input Register (read only)	-----	3X1-65535	DDDDD	
Output Register	-----	4X1-65535	DDDDD	

**Note:**

Mapping of address (same as \*10 relationships):

2-01 is to 4X2010

3-02 is to 4X3020

So address 4X1300 is to 1-30 as following picture, here is double word address. To get more information, please refer to danfoss manual.

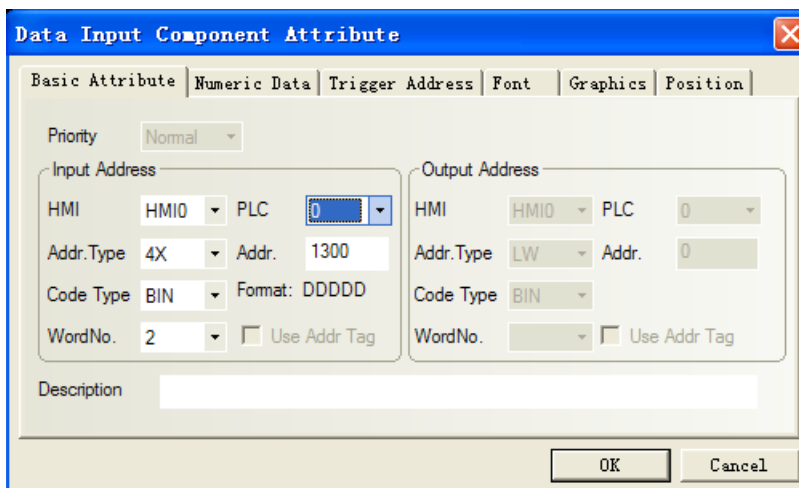

In addition, to get mapping address of startup, you should set bit of 3, 4, 5, 6,7,11 coil on:

0x047C=0000 0100 0111 1100

Set 0X 3, 0X 4, 0X 5, 0X 6, 0X 7, 0X 11 all to “1” (if random one of these registers is “0”,inverter will stop.

loop	0	1
------	---	---

01	Preset reference value LSB	
02	Preset reference value MSB	
03	DC brake	Do not DC brake
04	Inertial stop	Do not Inertial stop
05	Quickly stop	Do not Quickly stop
06	locking frequency	Do not locking frequency
07	Acc/Dec stop	start
08	Do not reset	reset
09	Do not inching	inching
10	Acc/Dec 1	Acc/Dec 2
11	valid data	invalid data
12	Relay 1 close	Relay 1 open
13	Relay 2 close	Relay 2 open
14	Set LSB	
15	Set MSB	
16	Do not reverse	reverse
Transducer controller word (FC structure)		

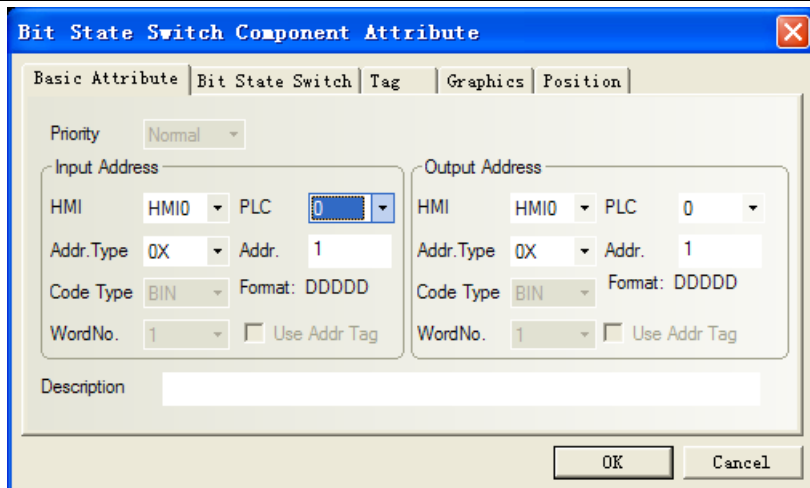

Set 0X 3, 0X 4, 0X 5, 0X 6, 0X 7 all to “1” via the method of setting on when window open; Change the inverter status (start or stop) by control the status of 0X11.

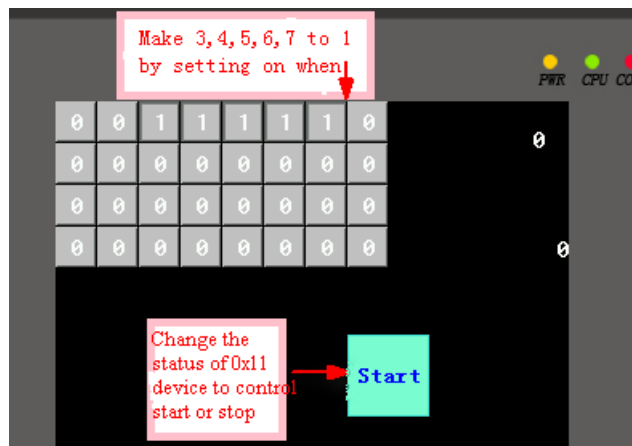

0x2000=0010 0000 0000 0000(binary bit from the 17th to the 32nd), setting the 30th bit to “1” means frequency is 25Hz, and “1” in the 29th bit means 12.5Hz, and so on. In short, the 0X17~0X32 is to

control frequency. The inverter will show the value after starting.

0X17~0X32 for controlling frequency, mapping as follows:

- 0x4000 ——50Hz
- 0x2000 ——25Hz
- 0x1000 ——12.5Hz (approximate)
- 0x800 ——6Hz

And so on, about 80 times

### ◎ Cable Diagram

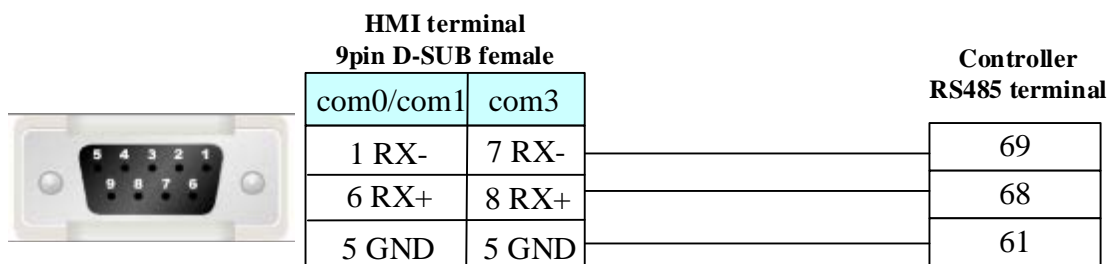

## 4.17 DCCE

### ◎ Serial communication

Series	CPU	Link Module	Driver
DCCE	MAC1110	RS485 on port	DCCE PLC Serial

### ◎ Network communication

Series	CPU	Link Module	Driver
DCCE	MAC1110	Ethernet interface on CPU	DCCE PLC Ethernet(TCP Slave)

### ◎ Serial System configuration

Series	CPU	Link Module	COMM Type	Parameter	Cable
DCCE	MAC1110	RS485 on port	RS485	<a href="#">Setting</a>	<a href="#">Your owner cable</a>

### ◎ Network System configuration

Series	CPU	Link Module	COMM Type	Parameter	Cable
DCCE	MAC1110	Ethernet interface on CPU	Ethernet	<a href="#">Setting</a>	<a href="#">Your owner cable</a>

### ◎ Serial Communication Setting

DCCE PLC Serial protocol

[HMI Setting](#)

HMI Default communication parameters: 9600bps, 8, none, PLC station: 1

RS485 communication

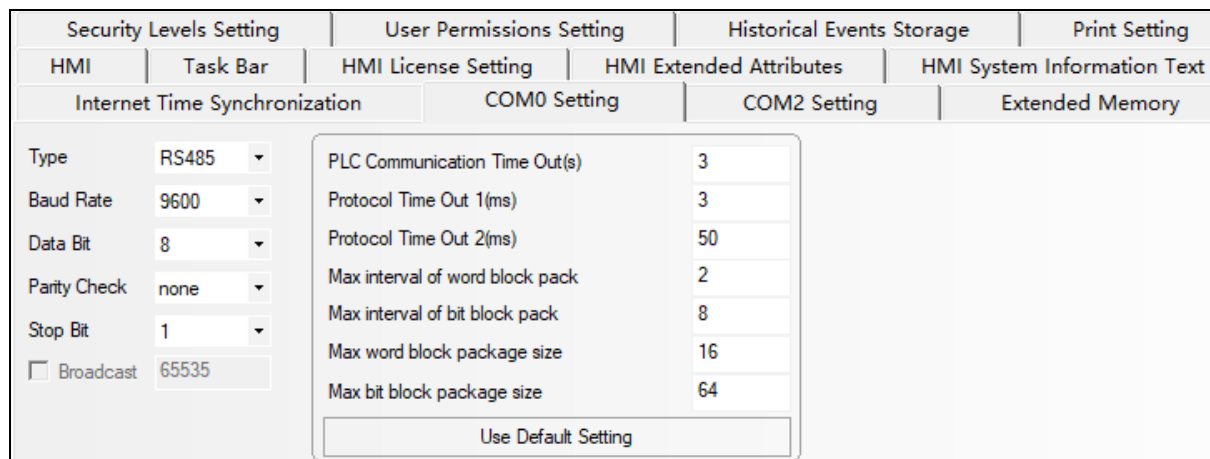

PLC configuration

- 1) Click on the controller to open the controller management and select the serial port settings.

⊙ Network Communication Setting

DCCE PLC Ethernet(TCP Slave) protocol

HMI Setting

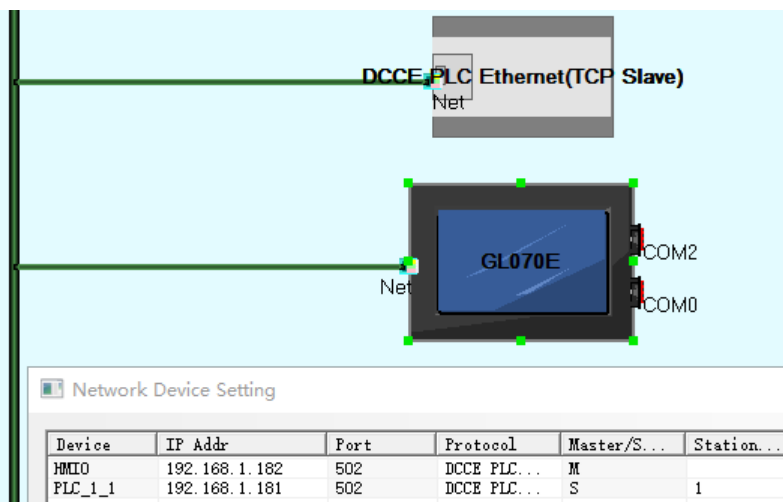

PLC configuration

- 1) Open the PLC\_Config software and create a new project.
- 2) Click Controller Management to add a controller.
- 3) Refresh controller list.

⊙ Supported Device

Device	Bit Address	Word Address	Format	Notes
Switch input	I0.00~3.15	-----	D.DD	
Switch output	Q0.00~3.15	-----	D.DD	
Memory variable	M0.00~255.15	-----	DDD.DD	
Sequence control	S0.00~15.15	-----	DD.DD	

Local variable	L0.00~15.15	-----	DD.DD	
User variables	V0.00~511.15	-----	DDD.DD	
Special function	SM0.00~511.15	-----	DDD.DD	
Analog input	-----	AI0~15	DD	
Analog output	-----	AQ0~15	DD	
Extended input	-----	XI0~255	DDD	
Extended output	-----	XQ0~255	DDD	
Extended analog input	-----	PAI0~255	DDD	
Variable analog input	-----	XAI0~511	DDD	
Extended analog output	-----	PAQ0~255	DDD	
Variable analog output	-----	XAQ0~511	DDD	
Timer	-----	T0~127	DDD	
Counter	-----	C0~127	DDD	
Keep forever	-----	P0~8191	DDDD	
Extended digital input	-----	EI0~31	DD	
Extended digital output	-----	EQ0~31	DD	
Extended analog input	-----	EAI0~255	DDD	
Extended analog output	-----	EAQ0~255	DDD	

©Cable Diagram

RS485 communication cable

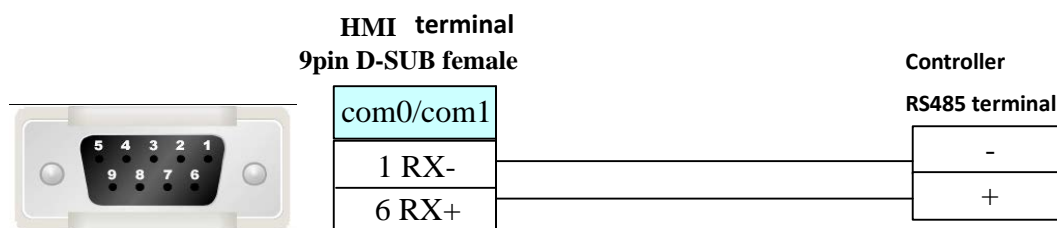

Ethernet communication protocol cable

Refer to 3.3Download by Network Ethernet



## 4.18 Delta Corporation

### ◎ Serial Communication

Series	CPU	Link Module	Driver
DVP	DVP14SS11R2 DVP 24 DVP 32	RS232 on the CPU unit	Delta DVP
	DVP 60ES00 DVP-XXES01	RS485 on port	
Delta AS300	AS332T	RS485 on port	Delta AS Series

### ◎ Ethernet Communication

Series	CPU	Link Module	Driver
DVP	DVP-32EH	DVPEN01-SL	Delta DVPEN01-SL Ethernet (TCP Slave)
AS300	AS332T	Ethernet interface on CPU	Delta AS300 Ethernet(TCP Slave)

### ◎ Serial System configuration

Series	CPU	Link Module	COMM Type	Parameter	Cable
DVP	DVP14SS11R2 DVP 24 DVP 32	RS232 on the CPU unit	RS232	<a href="#">Setting</a>	<a href="#">Your owner cable</a>
	DVP 60ES00 DVP-XXES01	RS485 on port	RS485	<a href="#">Setting</a>	<a href="#">Your owner cable</a>
Delta AS300	Delta AS300	RS485 on port	RS485	<a href="#">Setting</a>	<a href="#">Your owner cable</a>

### ◎ Ethernet Communication Parameters and Cables Production

Series	CPU	Link Module	COMM Type	Parameter	Cable
DVP	DVP-32EH	DVPEN01-SL	Ethernet	<a href="#">Setting</a>	<a href="#">Your owner cable</a>
AS300	AS332T	Ethernet interface on CPU	Ethernet	<a href="#">Setting</a>	<a href="#">Your owner cable</a>

### ◎ Serial Communication Setting

#### Use Delta DVP protocol

#### HMI setting

HMI default communication parameters: 9600bps, 7, even check, 1;PLC station no. : 1

#### RS232 communication

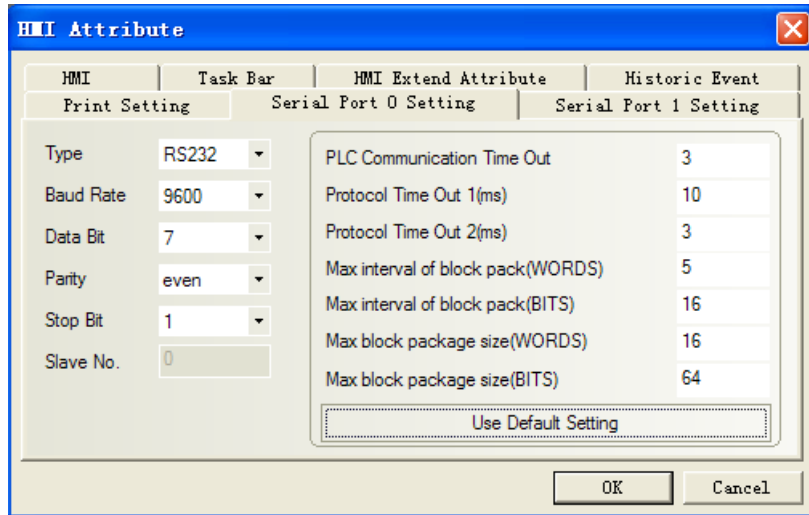

### RS485 communication

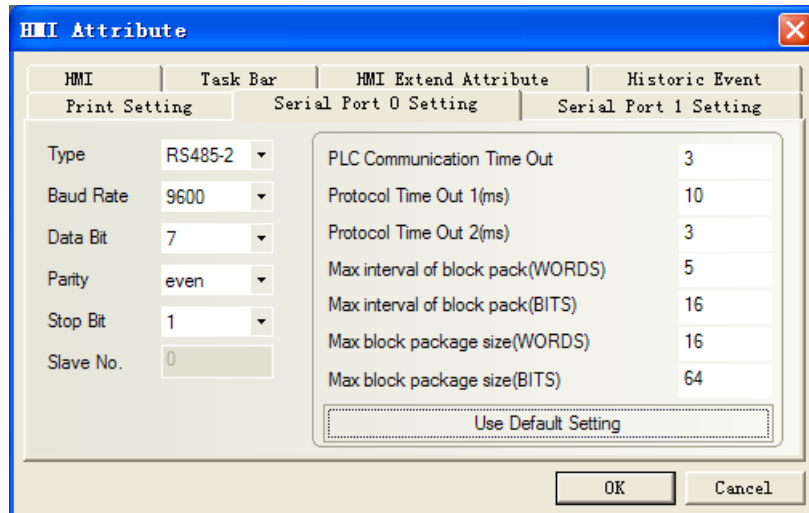

**Note:** RS485 communication, we should change the value of D1120 in the PLC Software.

### PLC setting

1. Wpl207->Auxiliary Editing->RS-485 Protocol Setting (D1120), you can set the value of D1120.

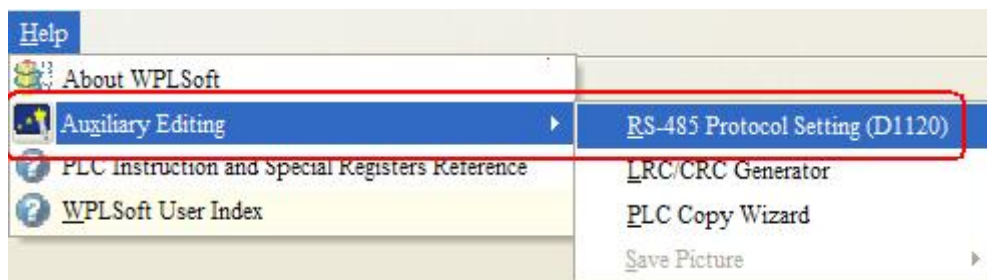

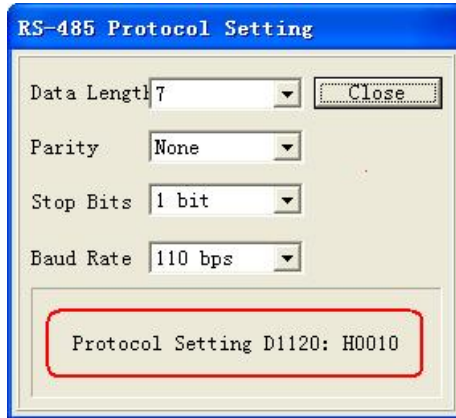

2. PLC connection with the Wpl207, monitoring changes in the value of D1120. for example, 9600, 7, even, 1. and then D1120=86 (HEX)

### Use Delta AS Series protocol

#### HMI setting

HMI default communication parameters: 9600bps, 7, even check, 1; PLC station no. : 1

#### RS485 communication

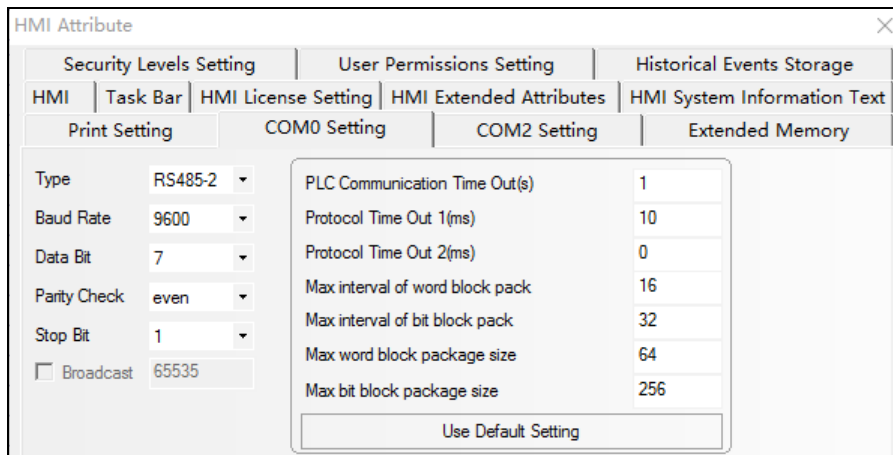

#### PLC setting

1. Open ISPSoft 3.01 PLC programming software, and click HWCONFIG after the new project.

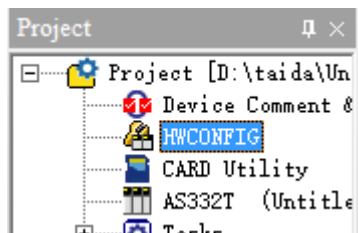

2. Double-click the PLC module, and the communication parameters are set as follows:

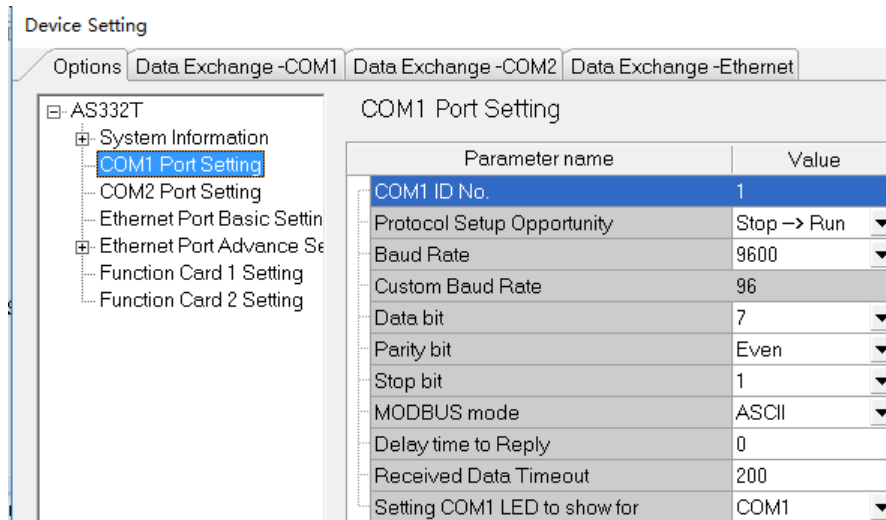

3. Establish global symbol -- master symbol table

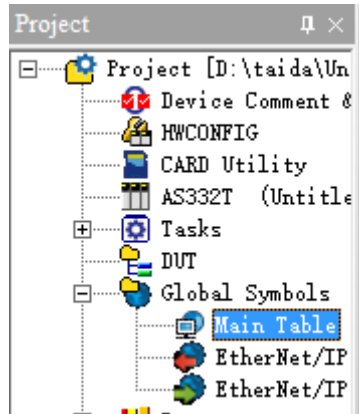

VAR	cc3	HC4	COUNTER	]
VAR	cc10	HC34	COUNTER	]
VAR	cc9	HC32	COUNTER	]
VAR	cc6	HC236	COUNTER	]
VAR	cc2	HC2	COUNTER	]
VAR	cc5	HC144	COUNTER	]

4. Add device monitoring table

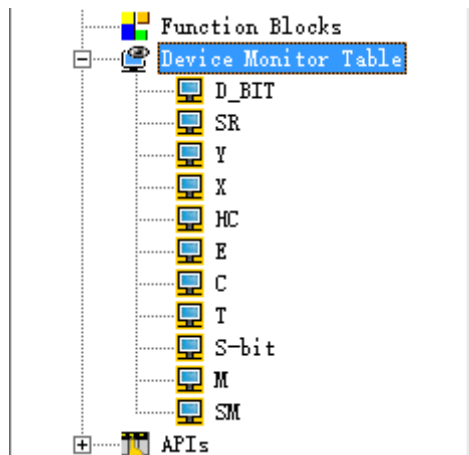

Object	Identifiers	Device Name	Status	Data Type
GlobalVar	FDGH	HC255		COUNTER
GlobalVar	jk	HC0		COUNTER
GlobalVar	AS	HC2		COUNTER

### ◎ Ethernet Communication Parameters

#### Delta DVPEN01-SL Ethernet (TCP Slave)

#### HMI Setting

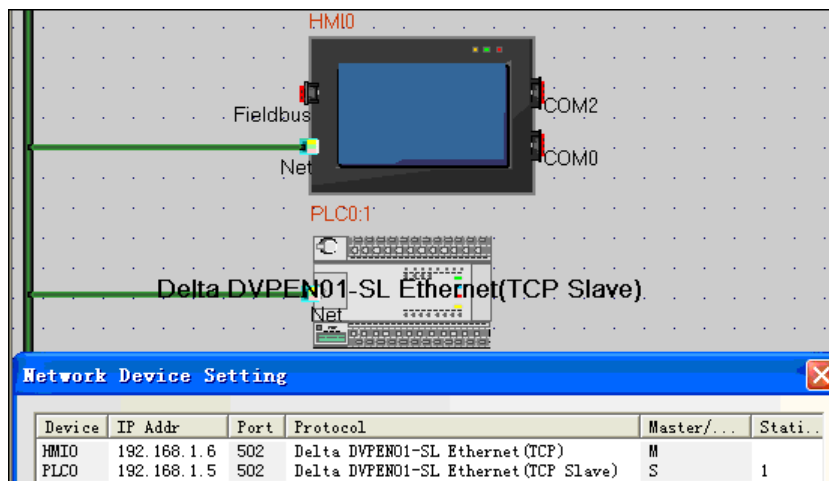

#### PLC Setting

1) Open the WPLSoft and build new project:

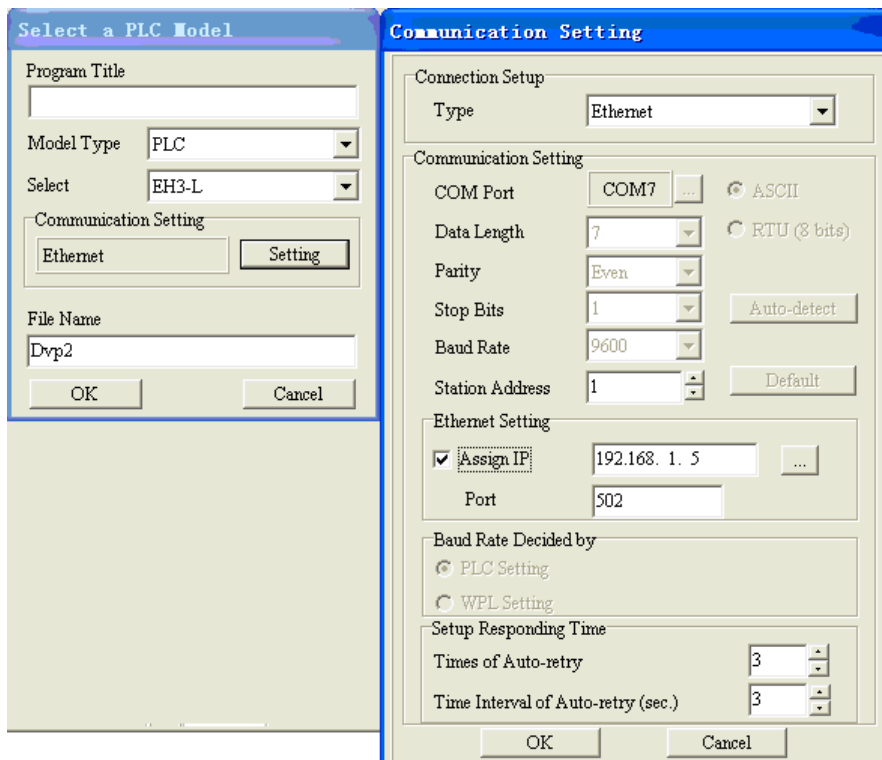

2) Change the IP address

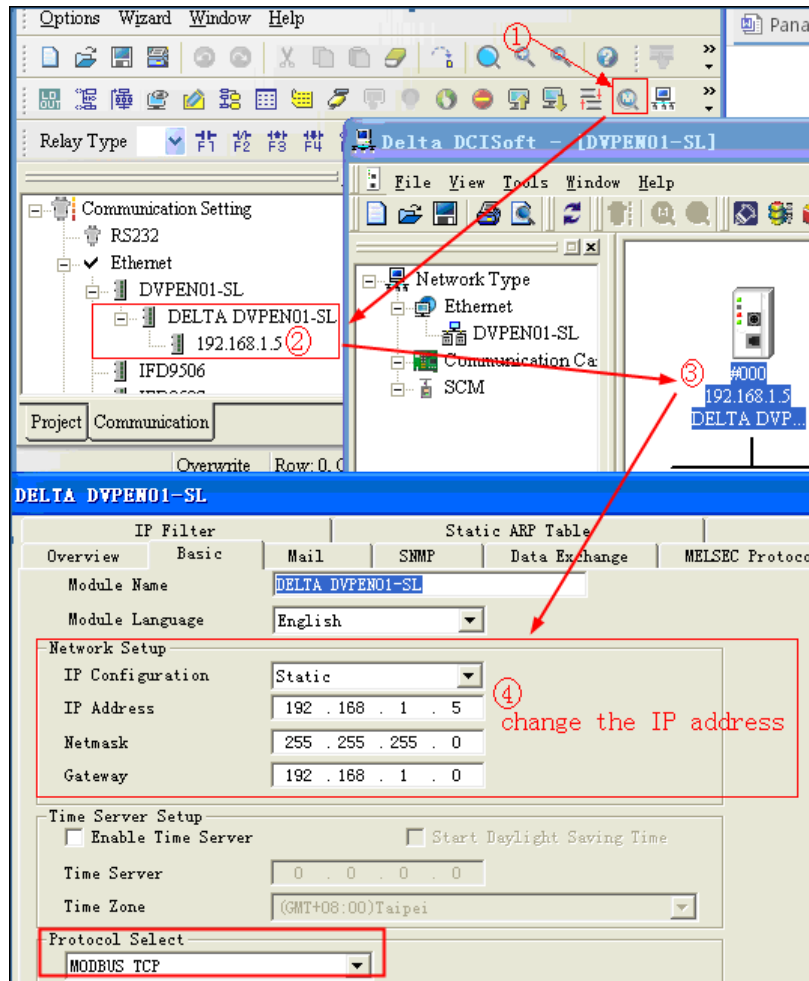

**Delta AS300 Ethernet(TCP Slave)  
HMI Setting**

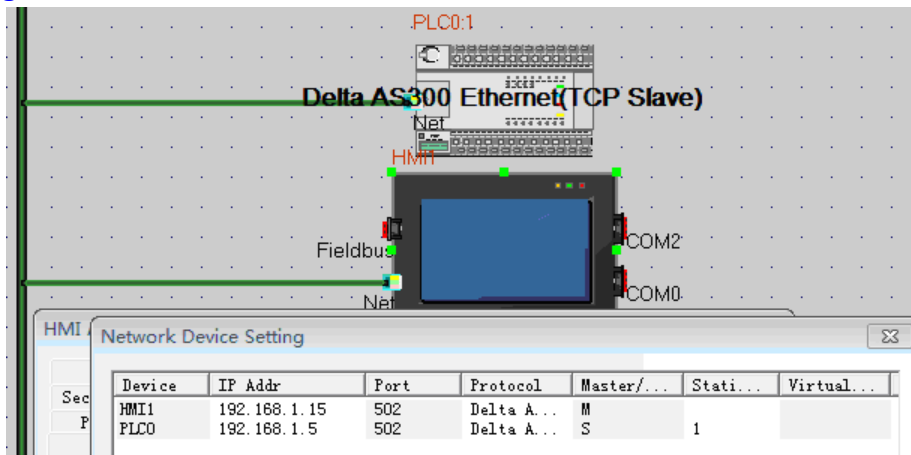

**PLC Setting**

5.Open ISPSoft,buld new project and choose the right CPU type.

6.PLC parameter setting:

© **Supported Device**

## Delta DVP

Device	Bit Address	Word Address	Format	Notes
Input	X0-9999	-----	OOOO	
Output	Y0-9999	-----	OOOO	
Auxiliary Relay	M0-9999	-----	DDDD	
Step Relay	S0-9999	-----	DDDD	
Timer Relay	T0-9999	-----	DDDD	
Counter Relay	C0-9999	-----	DDDD	
Timer	-----	TV0-9999	DDDD	
Counter	-----	CV0-127	DDD	
Double word counter	-----	CV2 232-255	DDD	
Data Register	-----	D0-9999	DDDD	

## Delta DVPEN01-SL Ethernet

Device	Bit Address	Word Address	Format	Notes
Input	X0-377	-----	OOO	
Output	Y0-377	-----	OOO	
Auxiliary Relay	M0-4095	-----	DDDD	
Step Relay	S0-1023	-----	DDDD	
Timer Relay	T0-255	-----	DDD	
Counter Relay	C0-255	-----	DDD	
Timer	-----	T0-255	DDD	
Counter	-----	C0-199	DDD	
Double word counter	-----	C2 200-255	DDD	
Data Register	-----	D0-11999	DDDDD	

## Delta AS300 Ethernet(TCP Slave)

Device	Bit Address	Word Address	Format	
32-bit Counter	HC 0-255	-----	DDD	
Counter	C 0-511	-----	DDD	
Timer	T 0--511	-----	DDD	
Step point Relay	S 0-2047	-----	DDDD	
Special auxiliary sign	SM 0-4095	-----	DDDD	
Special auxiliary	M 0-8191	-----	DDDD	
Output Relay	Y 0.00-63.15	-----	DD.DD	
Input Relay	X 0.00-63.15	-----	DD.DD	
Data Register	D 0.00-29999.15	-----	DDDDD.DD	
32-bit Counter	-----	HC 0-255	DDD	
Index Register	-----	E_Word 0-9	D	

Counter	-----	C 0--511	DDD	
Timer	-----	T 0-511	DDD	
Data Register	-----	D 0-29999	DDDDD	
Special data Register	-----	SR 0-2047	DDDD	
Output Relay	-----	Y 0-63	DD	
Input Relay	-----	X 0-63	DD	

◎ Cable Diagram

DVP RS232 communication cable

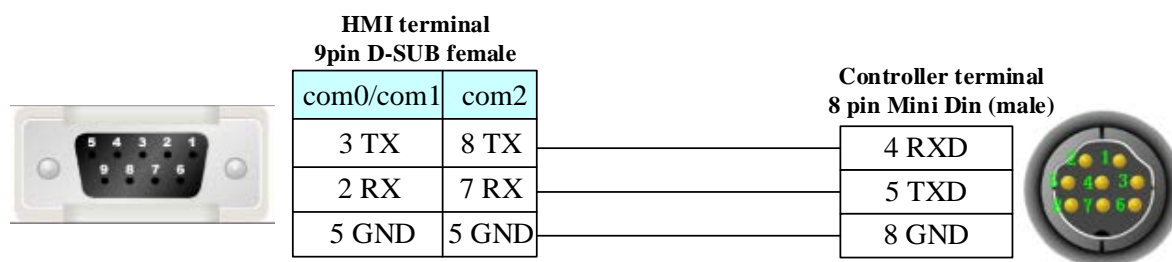

DVP \AS300 RS485 communication cable

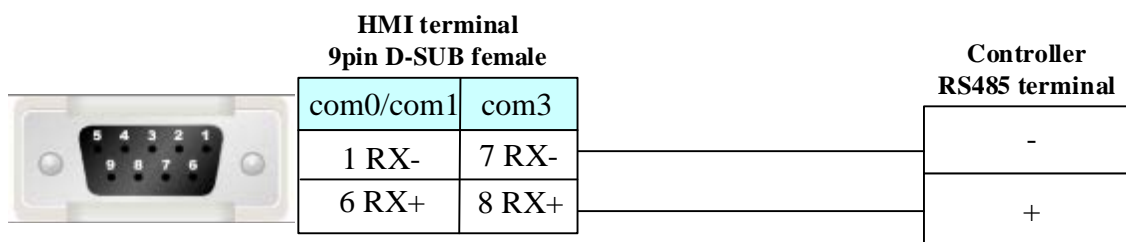

Ethernet communication protocol cable

Cross-connection or crossover network cable can be used as communication cable via the hub  
Refer to [3.3 Download by Network Ethernet](#) for method of making connection cable.

4.19 Delta (Temperature Controller)

◎ Serial Communication

Series	CPU	Link Module	Driver
DVP	DTA4848 DTB9696VR DTC1000 DTC2000	RS485 on the CPU unit	Delta DTA/DTB/DTC

◎ System configuration



Series	CPU	Link Module	COMM Type	Parameter	Cable
DVP	DTA4848 DTB9696VR DTC1000 DTC2000	RS485 on port	RS485	<a href="#">Setting</a>	<a href="#">Your owner cable</a>

## ◎ Communication Setting

### RS485 communication

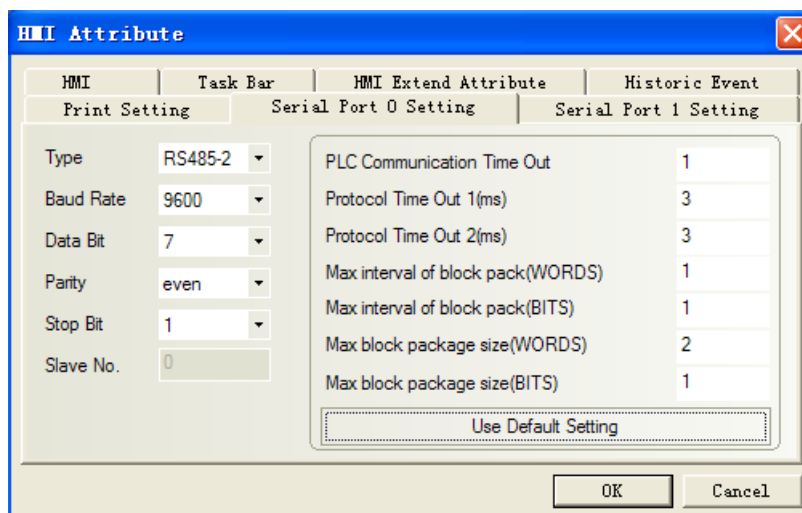

**NOTE:** Only use 4X, not 3X in the ev5000 project.

## ◎ Supported Device

Device	Bit Address	Word Address	Format	Notes
Output bit	0X1-FFFF	-----	HHHH	
Input bit (read only)	1X1-FFFF	-----	HHHH	
Input Register (read only)	-----	3X1-FFFF	HHHH	
Output Register	-----	4X1-FFFF	HHHH	

## Controller Setting

### 1. Set the communication parameter

Setting communication parameter in “setting mode”

- (1) **E-no** (Station number) matching the station No. of the Ev5000
- (2) **bPS** (Baudrate)
- (3) **LEn** (Data bit)
- (4) **PrtY** (Parity)
- (5) **Stop** (Stop bit)

Non-supported formats: 7, N, 1 or 8, O, 2 or 8, E, 2(Databit、Parity、Stopbit).

## (6) Setting the parameter of CoSH

The data must be ON when executing write operation in touch-screen.

**2. Communication parameters and notes**

**DTA4848:** Address and Content of Word Register (corresponds to 4X in the HMI)

Address	Content	Explanations
4700H	Process value (PV)	
4701H	Set point (SV)	
4702H	Upper-limit alarm 1	In the running mode <b>AL 1H</b> , when ALA1 is 1 and Upper-limit alarm is valid.
4703H	Lower-limit alarm 1	In the running mode <b>AL 1L</b> , when ALA1 is 1 and Lower-limit alarm is valid.
4704H	Upper-limit alarm 2	In the running mode <b>AL 2H</b> , when ALA2 is 2 and Upper-limit alarm is valid.
4705H	Lower-limit alarm 2	In the running mode <b>AL 2L</b> , when ALA2 is 2 and Lower-limit alarm is valid.
4706H	Upper-limit of temperature range	The data content should not be higher than the temperature range. In the setting mode <b>SP-H</b>
4707H	Lower-limit of temperature range	The data content should not be lower than the temperature range. In the setting mode <b>SP-L</b>
4708H	PB Proportional band	1 to 9999, unit is 0.1. In the adjusting mode <b>P</b>
4709H	Ti Integral time	0~9999. In the adjusting mode <b>i</b>
470AH	Td Derivative time	0~9999. In the adjusting mode <b>d</b>
470BH	Heating/Cooling hysteresis	0~9999
4710H	Input temperature sensor type	In the setting mode <b>INPt</b>
4711H	Control method	0: PID (default), 1: ON/OFF, 2: manual tuning. In the setting mode <b>CTRL</b>
4712H	Heating/Cooling control cycle	0 to 99 second, 0:0.5s, in the adjusting mode <b>HEPd</b> or <b>CLPd</b> , when it is under the control of PID
4713H	Proportional control offset error value	0%~100%

4714H	Temperature regulation value	-99.9~99.9. in the adjusting mode <b>EPoF</b>
4715H	Alarm 1 type	Please refer to the contents of the “Alarm Outputs” for detail. In the setting mode <b>ALA1</b>
4716H	Alarm 2 type	Please refer to the contents of the “Alarm Outputs” for detail. In the setting mode <b>ALA2</b>
4717H	Temperature unit display selection	°C : 1 (default), °F : 0. in the setting mode <b>EPUn</b>
4718H	Heating/Cooling control Selection	Heating: 0 (default), Cooling: 1. in the setting mode <b>S-HC</b>
4719H	Control Run/Stop setting	Run: 1 (default), Stop: 0. in the running mode <b>r-S</b>
471AH	Communication write-in selection	Communication write in disabled: 0 (default), Communication write in enabled: 1. In the setting mode <b>CoSH</b>
471BH	Software Version	V1.00 indicates 0 x 100
4729H	AT Setting	OFF: 0 (default), ON: 1. in the adjusting mode <b>At</b>
4733H	CT monitor value	Unit is 0.1A. in the running mode <b>Et</b>

**DTB9696VR:** Address and Content of Word Register (corresponds to 4X in the HMI)

Address	Content	Explanation
1000H	Process value (PV)	Measuring unit is 0.1, updated one time in 0.4 second
1001H	Set point (SV)	Unit is 0.1, °C or °F
1002H	Upper-limit of temperature range	The data content should not be higher than the temperature range. In the setting mode <b>EP-H</b>
1003H	Lower-limit of temperature range	The data content should not be lower than the temperature range. In the setting mode <b>EP-L</b>
1004H	Input temperature sensor type	Please refer to the contents of the “Temperature Sensor Type and Temperature Range” for detail. In the setting mode <b>EnPt</b>
1005H	Control method	0: PID, 1: ON/OFF, 2: manual tuning, 3: PID program control. In the setting mode <b>Et-L</b>
1006H	Heating/Cooling control selection	0: Heating, 1: Cooling, 2: Heating/Cooling, 3:

		Cooling/Heating. In the setting mode <b>S-HC</b>
1007H	1st group of Heating/Cooling control cycle	0 ~ 99, 0:0.5 sec. in the adjusting mode <b>HtPd</b> or <b>CLPd</b>
1008H	2nd group of Heating/Cooling control cycle	0 ~ 99, 0:0.5 sec. in the adjusting mode <b>HCPd</b>
1009H	PB Proportional band	0.1 ~ 999.9. in the adjusting mode <b>PD</b>
100AH	Ti Integral time	0~9999. in the adjusting mode <b>IO</b>
100BH	Td Derivative time	0~9999. in the adjusting mode <b>DO</b>
100CH	Integration default	0 ~ 100%, unit is 0.1%. in the adjusting mode <b>IOFO</b>
100DH	Proportional control offset error value, when Ti = 0	0 ~ 100%, unit is 0.1%. in the adjusting mode <b>Pdof</b>
100EH	The setting of COEF when Dual Loop output control are used	0.01 ~ 99.99, unit is 0.01 (setting when it is under the control of PID ) in the adjusting mode <b>COEF</b>
100FH	The setting of Dead band when Dual Loop output control are used	-999 ~ 9,999. in the adjusting mode <b>dEAd</b>
1010H	Hysteresis setting value of the 1st output group	0~9999. in the adjusting mode <b>HtS</b> or <b>CLs</b>
1011H	Hysteresis setting value of the 1st output group	0~9999. (setting when Dual Loop output control are used ) in the adjusting mode <b>HtS</b> or <b>CLs</b>
1012H	Hysteresis setting value of the 1st output group	Unit is 0.1%; write operation is valid under manual tuning mode only. In the running mode <b>out1</b>
1013H	Hysteresis setting value of the 2nd output group	Unit is 0.1%; write operation is valid under manual tuning mode only. In the running mode <b>out2</b>
1014H	Upper-limit regulation of analog linear output	1 Unit = 2.8uA (Current Output) = 1.3mV (Linear Voltage Output) in the adjusting mode <b>CrH</b>
1015H	Lower-limit regulation of analog linear output	1 Unit = 2.8uA (Current Output) = 1.3mV (Linear Voltage Output) in the adjusting mode <b>CrLo</b>
1016H	Temperature regulation value	-99.9 ~ +99.9, unit: 0.1. in the adjusting mode <b>tPoF</b>

1017H	Analog decimal setting	0~3. in the running mode <b>SP</b>
1018H	Time for valve from full open to full close	0.1~999.9. in the adjusting mode <b>uAtr</b>
1019H	Dead Band setting of valve	0 ~ 100%; unit: 0.1%. in the adjusting mode <b>u-dE</b>
101AH	Upper-limit of feedback signal set by valve	0~1024. in the adjusting mode <b>u-HL</b>
101BH	Lower-limit of feedback signal set by valve	0~1024. in the adjusting mode <b>u-Lo</b>
101CH	PID parameter selection	0~4. in the adjusting mode <b>P<sub>dn</sub></b>
101DH	SV value corresponded to PID value	Only valid within available range, unit: 0.1 scale. in the adjusting mode <b>Su0</b>
1020H	Alarm 1 type	In the setting mode <b>ALA1</b>
1021H	Alarm 2 type	In the setting mode <b>ALA2</b>
1022H	Alarm 3 type	In the setting mode <b>ALA3</b>
1023H	System alarm setting	0: None (default), 1~3: Set Alarm 1 to Alarm 3. In the setting mode <b>SALA</b>
1024H	Upper-limit alarm 1	In the setting mode <b>AL1H</b> unit: 0.1
1025H	Lower-limit alarm 1	In the setting mode <b>AL1L</b>
1026H	Upper-limit alarm 2	In the setting mode <b>AL2H</b>
1027H	Lower-limit alarm 2	In the setting mode <b>AL2L</b>
1028H	Upper-limit alarm 3	In the setting mode <b>AL3H</b>
1029H	Lower-limit alarm 3	In the setting mode <b>AL3L</b>
102AH	Read LED status	b0 : Alm3, b1: Alm2, b2: F, b3: °C, b4: Alm1, b5: OUT2, b6: OUT1, b7: AT
102BH	Read pushbutton status	b0: Set, b1: Select, b2: Up, b3: Down. 0 is to push
102CH	Setting lock status	0: Normal, 1: All setting lock, 11: Lock others than SV value. In the running mode <b>LoL</b>
102DH	CT read value	Unit: 0.1A. In the running mode <b>Ct</b>

102FH	software version	V1.00 indicates 0x100.
1030H	Start pattern number	0 ~ 7. In the running mode <b>Pt<sub>n</sub></b> (setting when it is under the control of PID and the mode of <b>PSLP</b> )
1040H~ 1047H	Actual step number setting inside the correspond pattern	0 ~ 7 = N, indicate that this pattern is executed from step 0 to step N. in the setting mode <b>PS<sub>Y</sub>0</b>
1050H~ 1057H	Cycle number for repeating the execution of the correspond pattern	0 ~ 99 indicate that this pattern has been executed for 1 ~ 100 times. In the setting mode <b>CYC0</b>
1060H~ 1067H	Link pattern number setting of the correspond pattern	0 ~ 8, 8 indicates the program end. 0~7 indicates the next execution pattern number after executing the current pattern. In the setting mode <b>LN0</b>
2000H~ 203FH	Pattern 0~7 temperature set point setting(Pattern 0 temperature is set to2000H ~ 2007H)	-999 ~ 9,999. in the setting mode <b>SP00 ~ SP07</b>
2080H~ 20BFH	Pattern 0~7 execution time setting(Pattern 0 time is set to 2080H~2087H)	Time 0 ~ 900 (1 minute per scale). in the setting mode <b>EL00 ~ EL07</b>

**DTB9696VR: Address and Content of Bit Register (corresponds to 1X in the HMI)**

0810H	Communication write-in selection	Communication write in disabled: 0 (default), Communication write in enabled: 1.  In the setting mode <b>CoSH</b>
0811H	Temperature unit display selection	°C/linear input (default): 1 , °F : 0. in the setting mode <b>EPUn</b>
0812H	Decimal point position selection	Except for the thermocouple B, S, R type, all the other thermocouple type are valid. (0 or 1).  In the running mode <b>SP</b>
0813H	AT setting	OFF: 0 (default), ON : 1.  In the adjusting mode <b>At</b>
0814H	Control RUN/STOP setting	0: STOP, 1: RUN (default).  In the running mode <b>r-S</b>
0815H	STOP setting for PID program control	0: RUN (default), 1: STOP.  In the running mode <b>r-S</b>
0816H	Temporarily STOP for PID program control	0: RUN (default), 1: Temporarily STOP.

		In the running mode <b>r-5</b>
0817H	Valve feedback setting status	0: w/o feedback (default), 1: feedback function.
0818H	Auto-tuning valve feedback status	0: Stop AT (default), 1: Start AT

### 3. Communication Parameters List

- Communication protocol: Modbus (ASCII); Available communication address: 1 to 255, 0 is broadcast address
- Function code: 03H: read the contents of register (Max. 3 words).  
06H: write 1 (one) word into register.

### ◎ Cable Diagram

#### DVP RS485 communication cable

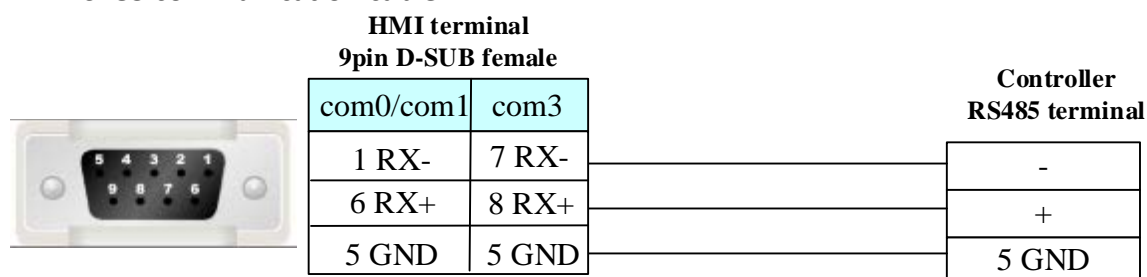

## 4.20 DL\_T645 2007 Standard (Electric power meter)

\* the instrument for testing is "CHINT" DTS634 type power instrument, standard 07 protocol.

### ◎ Serial Communication

Series	Link Module	Driver
DTS634 devices	RS485 on the CPU unit	DL_T645 2007 Standard

### ◎ System configuration

Series	Link Module	COMM Type	Parameter	Cable
DTS634 devices	RS485 on the CPU unit	RS485	<a href="#">Setting</a>	<a href="#">Your owner cable</a>

### ◎ Communication Setting

#### HMI setting

Default communication: 9600, 8, 1, Even; station: 1

1.HMI attribute setting

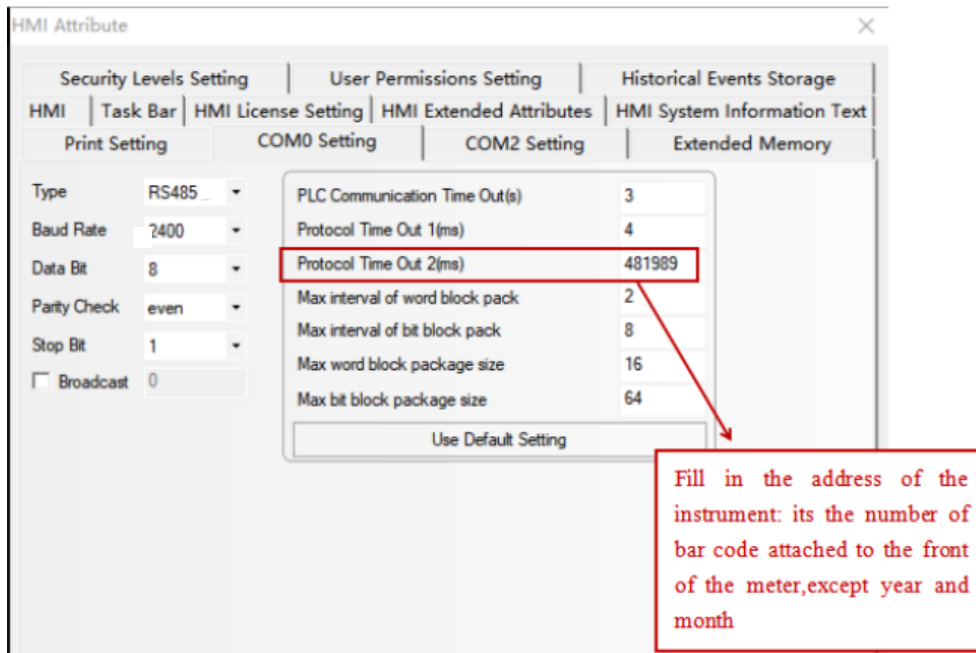

2.oject interface:

Put a data input element: address data1(Read the power)



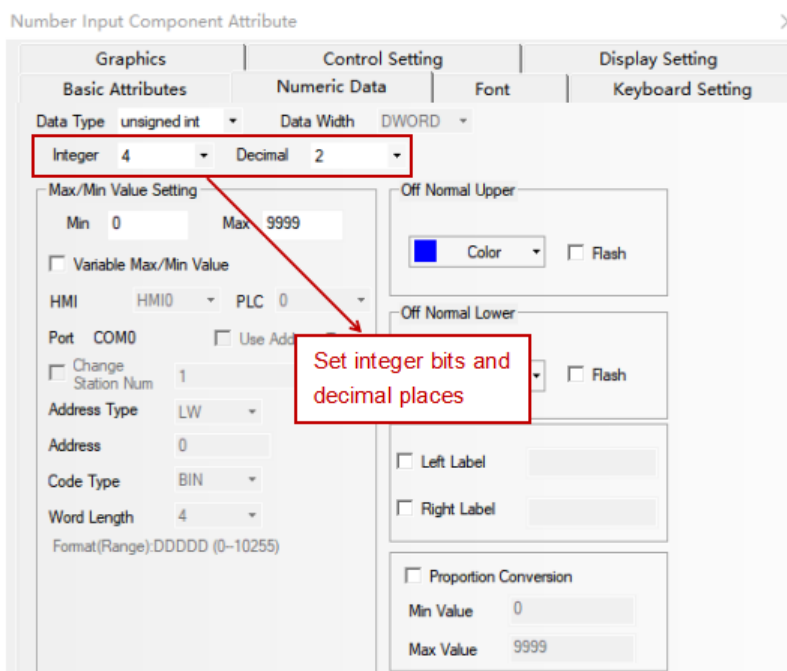
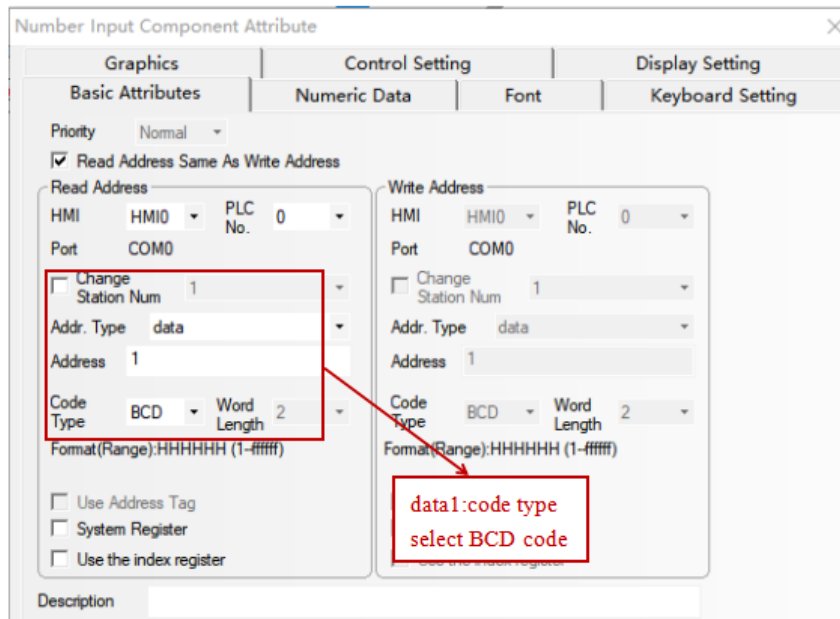

The final display results:

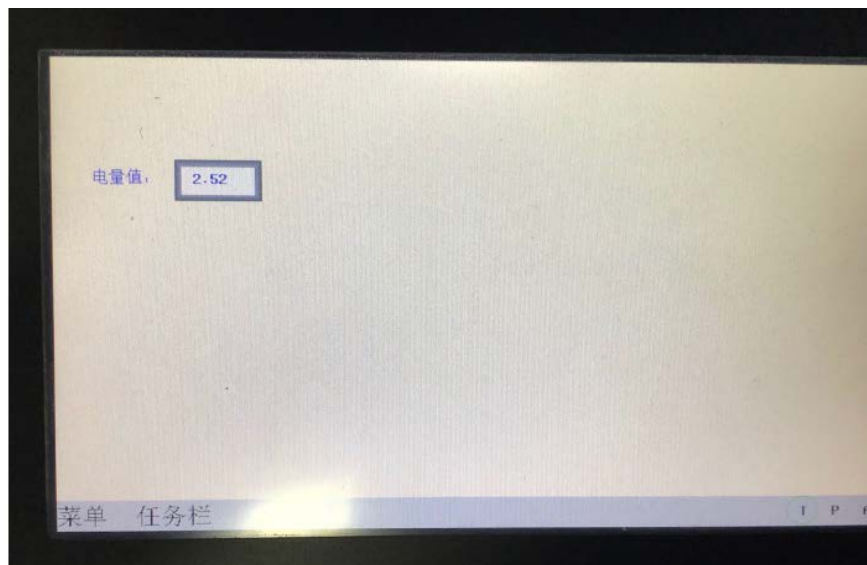

◎ Supported Device

**DTS634 Devices**

Device	Word Address	Format	Code type	Notes
DTS634	data1	HHHHH	BCD	----

◎ Cable Diagram

**RS485 communication cable**

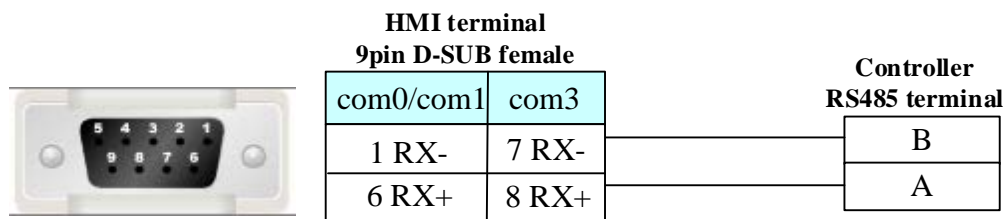

## 4.21 ENDA

### ◎Serial Communication

Series	CPU	Link Module	Driver
ENDA devices	ELC	RS485 on the CPU unit	ENDA Controller/PLC Devices
	ETC	RS485 on the CPU unit	
	EUC	RS485 on the CPU unit	
	EPC	RS485 on the CPU unit	
	EDP	RS485 on the CPU unit	

### ◎System configuration

Series	CPU	Link Module	COMM Type	Parameter	Cable
ENDA devices	ELC	RS485 on the CPU unit	RS485	<a href="#">Setting</a>	<a href="#">Your owner cable</a>
	ETC	RS485 on the CPU unit	RS485		
	EUC	RS485 on the CPU unit	RS485		
	EPC	RS485 on the CPU unit	RS485		
	EDP	RS485 on the CPU unit	RS485		

### ◎Communication Setting

**ENDA Devices:**Default communication:9600, 8, 1, none; station: 1

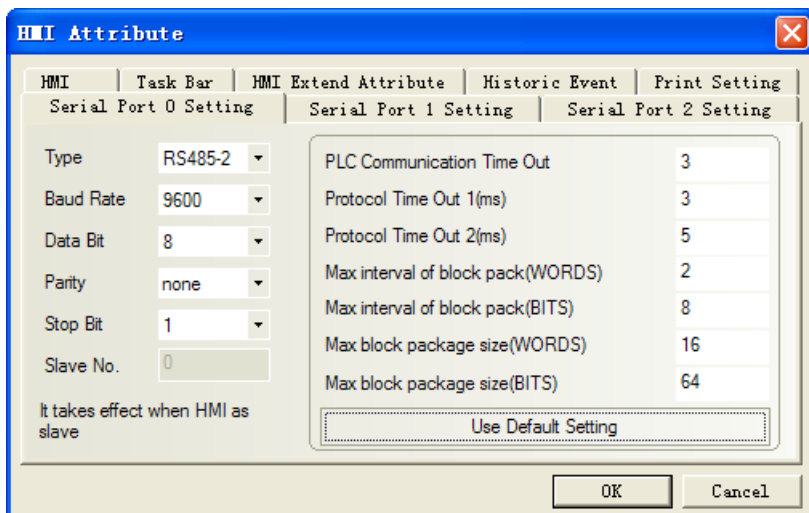

### ◎ Supported Device

#### ENDA PLC Devices

Device	Bit Address	Word Address	Format	Notes
Output Relay	MB 0-65535	-----	DDDDD	
Input Relay (read only)	IP 0-65535	-----	DDDDD	
Output Register	-----	MW 0-65535	DDDDD	
Input Register (read only)	-----	IR 0-65535	DDDDD	

#### ENDA Controller Devices

Device	Bit Address	Word Address	Format	Notes
Coils	Coils 0-65535	-----	DDDDD	
Discrete input (read only)	DI 0-65535	-----	DDDDD	
Holding Registers	-----	HR 0-65535	DDDDD	
Input Register (read only)	-----	IR 0-65535	DDDDD	

### ◎ Cable Diagram

#### RS485 communication cable

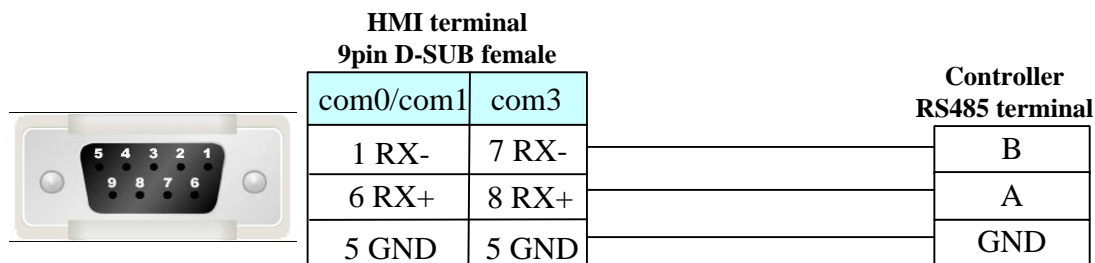

## 4.22 Emerson NetWork Power

### ◎ Serial Communication

Series	CPU	Link Module	Driver
Emerson EC10	Ec10-1006BRA	RS232 on the CPU unit	Emerson EC10
Emerson EC20	Ec20-2012BRA Ec20-3232BRA	RS232 on the CPU unit	Emerson EC20

### ◎ System configuration

Series	CPU	Link Module	COMM Type	Parameter	Cable
Emerson EC10	EC10-1006BRA	RS232 on the CPU unit	RS232	<a href="#">Setting</a>	<a href="#">Your owner cable</a>
		RS485 on port1	RS485	<a href="#">Setting</a>	<a href="#">Your owner cable</a>
Emerson EC20	EC20-2012BRA EC20-3232BRA	RS232 on the CPU unit	RS232	<a href="#">Setting</a>	<a href="#">Your owner cable</a>
		RS485 on port1	RS485	<a href="#">Setting</a>	<a href="#">Your owner cable</a>

### ◎ Communication Setting

#### Emerson EC10 RS232 communication

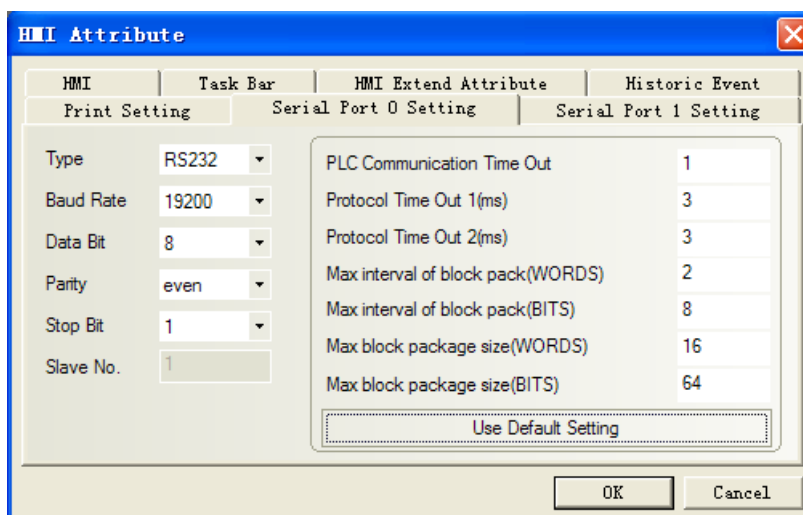

#### Emerson EC20 RS232 communication

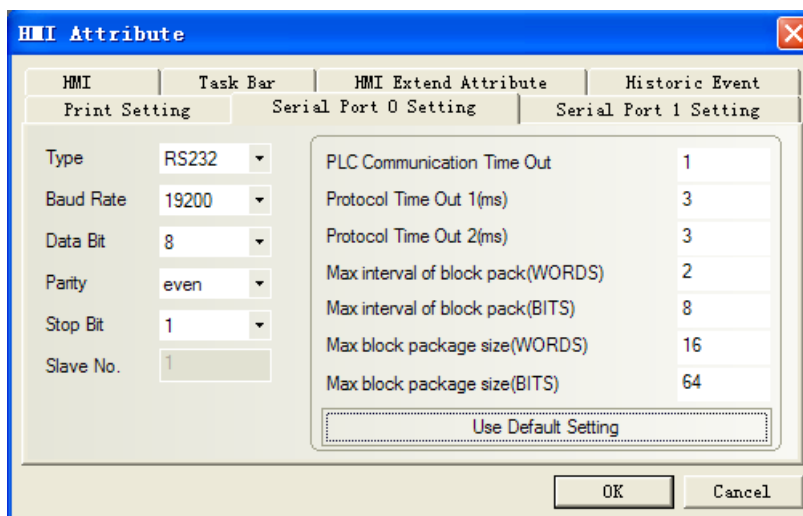

#### Emerson EC10 RS485 communication

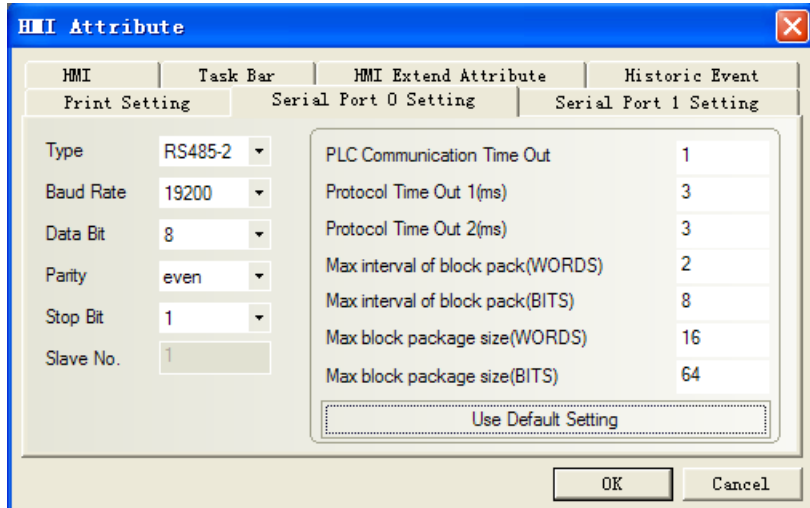

### Emerson EC20 RS485 communication

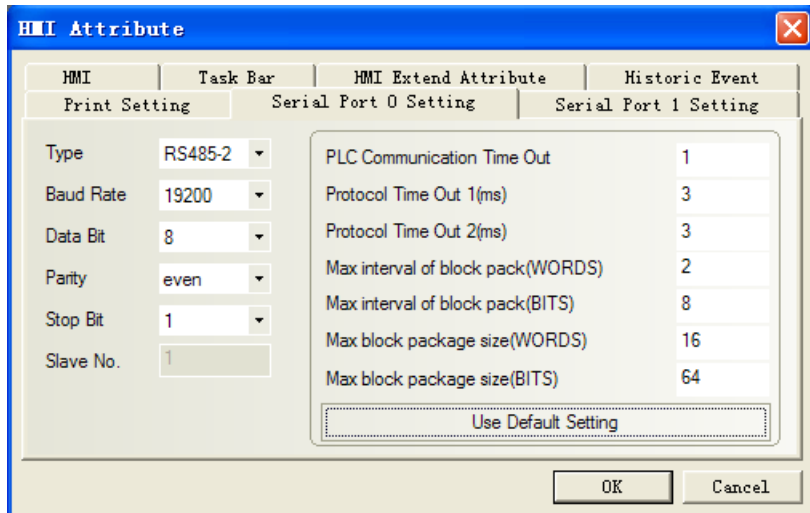

**NOTE:** Communication with port1, you must set the system configuration in the programming software first.

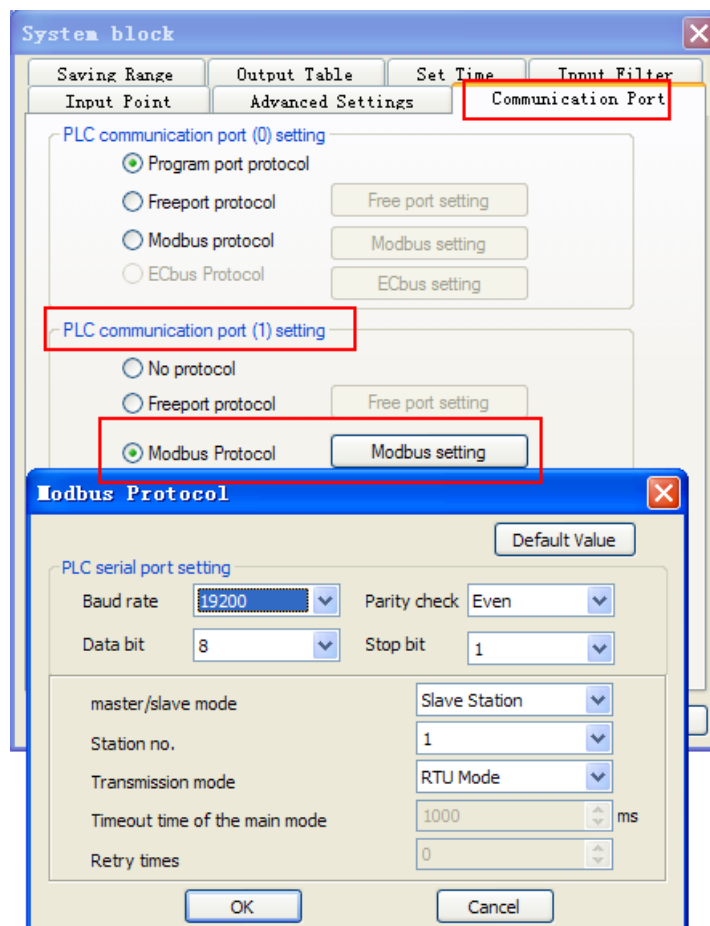

◎ Supported Device

Emerson EC10

Device	Bit Address	Word Address	Format	Notes
Input Relay	X000-377	-----	OOO	
Output Relay	Y000-377	-----	OOO	
Internal Relay	M0000-1999	-----	DDDD	
Special Relay	SM000-255	-----	DDD	
Step Relay	S000-991	-----	DDD	
Timer Relay	T000-255	-----	DDD	
Counter Relay	C000-255	-----	DDD	
Data register	-----	D0000-7999	DDDD	
Special Register	-----	SD000-255	DDD	
Index Register	-----	Z00-15	DD	
Timer	-----	T000-255	DDD	
Counter	-----	C000-199	DDD	
Counter(double word)	-----	C_Double200-255	DDD	
Data register(double word)	-----	D_Double0000-7999	DDDD	
Special Register(double word)	-----	SD_Double000-127	DDD	

### Emerson EC20

Device	Bit Address	Word Address	Format	Notes
Input Relay	X000-377	-----	OOO	
Output Relay	Y000-377	-----	OOO	
Internal Relay	M0000-1999	-----	DDDD	
Special Relay	SM000-255	-----	DDD	
Step Relay	S000-991	-----	DDD	
Timer	T000-255	-----	DDD	
Counter	C000-255	-----	DDD	
Data register	-----	D0000-7999	DDDD	
Special Register	-----	SD000-255	DDD	
Index Register	-----	Z00-15	DD	
Timer	-----	T000-255	DDD	
Counter	-----	C000-199	DDD	
Counter(double word)	-----	C_Double200-255	DDD	
Data register(double word)	-----	D_Double0000-7999	DDDD	
Special Register(double word)	-----	SD_Double000-125	DDD	

### ☉ Cable Diagram

#### Emerson RS232 communication

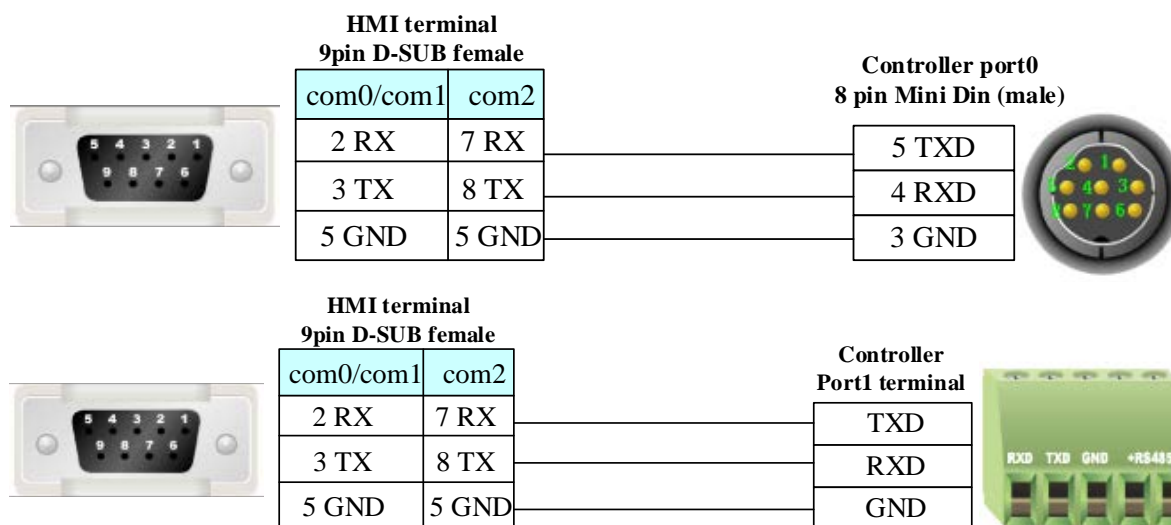

#### Emerson RS485 communication

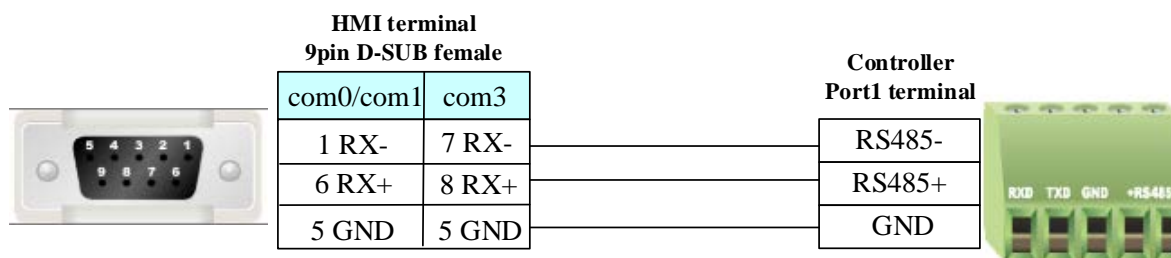



## 4.23 Epower

### ◎ Serial Communication

Series	CPU	Link Module	Driver
Epower	Epower	CPU Direct	EPower
			Epower Slave

### ◎ System configuration

Series	CPU	Link Module	COMM Type	Parameter	Cable
Epower	Epower	CPU Direct	RS232	<a href="#">Setting_</a>	<a href="#">Your owner cable</a>
				<a href="#">Setting_</a>	<a href="#">Your owner cable</a>

### ◎ Communication Setting

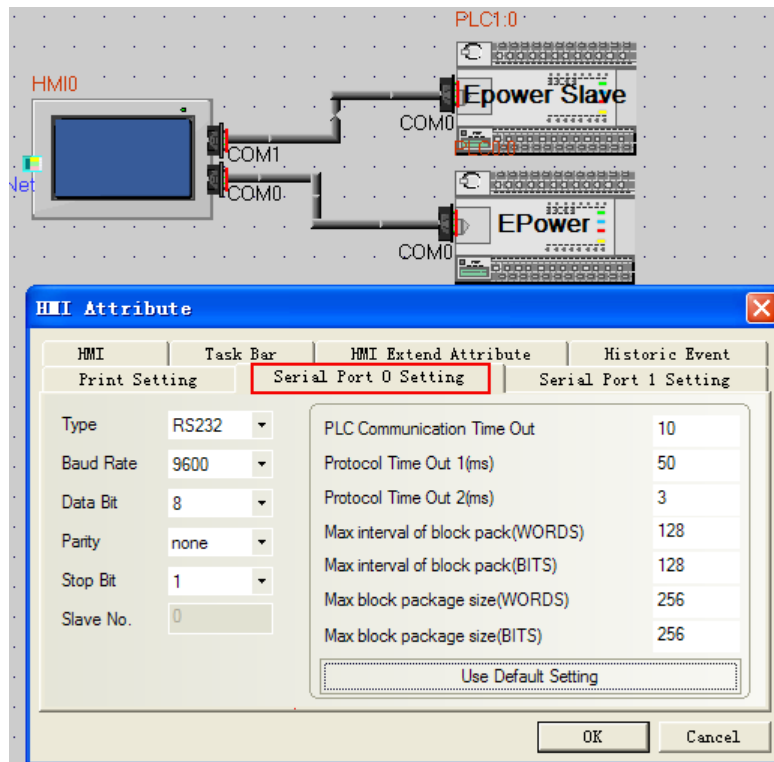

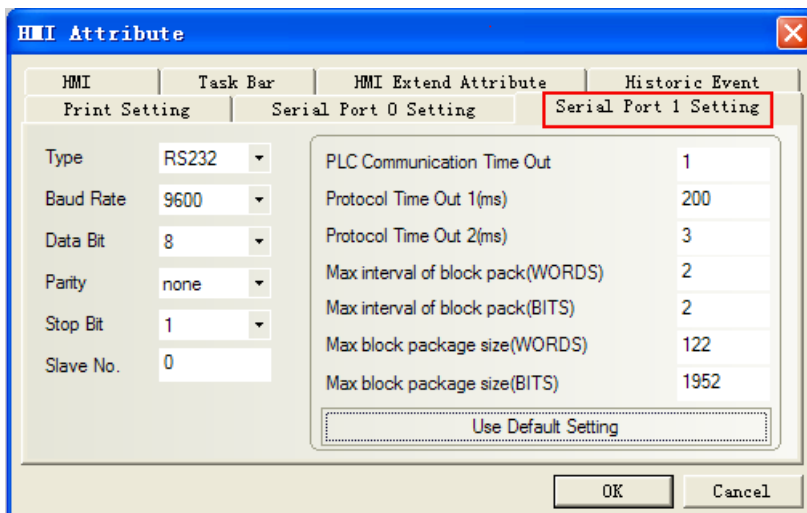

### ◎ Supported Device

Device	Bit Address	Word Address	Format	Notes
UPSSet	UPSSet1-6	-----	DDDDD	
UPSPanel	UPSPanel0-9	-----	DDDDD	
UPSDData	-----	UPSDData0-70	DDDD	
UPSDisp	-----	UPSDisp0	DDDDD	
UPSCCommand	-----	UPSCCommand0-52	DDDDD	
UPSText	-----	UPSText0-1	DDDDD	

#### Slave driver notes:

1. Transmit the device value to LW, LB by timer; refer to the addr table for details.
2. UPSCCommand must use with UPSSet、macro;
3. UPSDisp must use with UPStexr、UPSPanel、macro.

#### Epower HMI project notes:

1. The project must have UPSData0 device, otherwise the data accuracy will be affected; Suggest to put UPSData0 device in the public window.
2. LW.B indicates the bits of UPSData

### ◎ Cable Diagram

#### COM0 connect to ups communication board

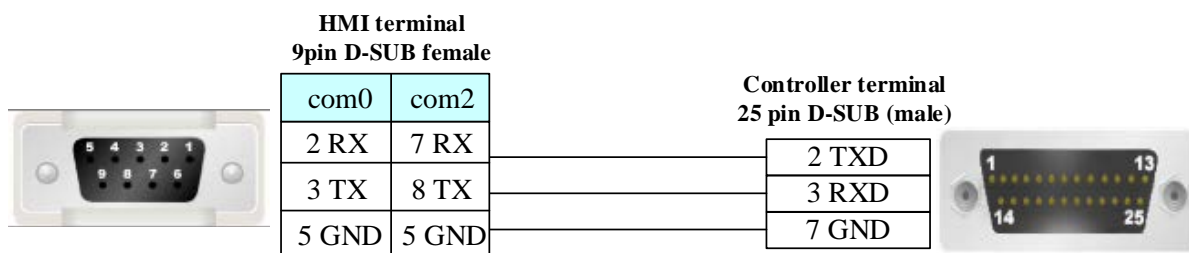

#### COM1 connect to King software or com debug tool

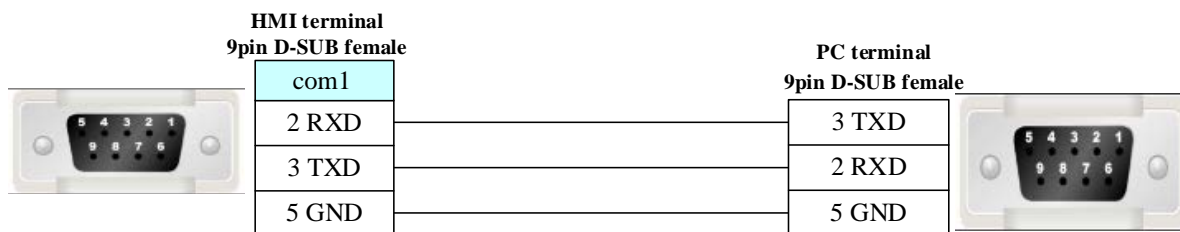

## 4.24 Fatek Corporation

### ◎ Serial Communication

c	CPU	Link Module		Driver
FBs	FBs-10MA/MC	RS232 on the CPU unit	Port 0	FATEK FB Modbus RTU
	FBs-14MA/MC	FBS-CB25-3	Port 1	
	FBs-20MA/MC		Port 2	
	FBs-24MA/MC			
	FBs-32MA/MC			
	FBs-40MA/MC			
	FBs-60MA/MC			
	FBs-20MN			
	FBs-32MN			
	FBs-44MN			
FBe/FBn	FBe-20MA	CPU unit	Port 0	FATEK FB Modbus RTU
	FBe-28MA			
	FBe-40MA			
	FBe-20MC	CPU unit	Port 0	
	FBe-28MC		Port 1	
	FBe-40MC		Port 2	
	FBn-19MCT	FB-DTBR		
	FBn-26MCT	FB-DTBR-E		
FBn-36MCT				

### ◎ Network communication

Series	CPU	Link Module	Driver
FBs	FBs-20MAT	FBs-CBE-3	FATEK FB Ethernet(TCP)

### ◎ Serial System configuration

Driver	Series	CPU	Link Module	COMM Type	Parameter	Cable
FACON FB	FB MA FB MC	FBs-20MAT	RS232 on the CPU unit	RS232	<a href="#">Setting</a>	<a href="#">Your owner cable</a>
				FBS-CB25-3	RS232	<a href="#">Setting</a>
					RS485	<a href="#">Setting</a>
Modbus	FB MA	FBs-20MAT	FBS-CB25-3	RS232	<a href="#">Setting</a>	<a href="#">Your owner cable</a>

RTU	FB MC			RS485	<a href="#">Setting</a>	<a href="#">Your owner cable</a>
-----	-------	--	--	-------	-------------------------	----------------------------------

◎ Network System configuration

Series	CPU	Link Module	COMM Type	Parameter	Cable
FBs	FBs-20MAT	FBs-CBE-3	ETH	<a href="#">Setting</a>	<a href="#">Your owner cable</a>

◎ Serial Communication Setting

FACON FB RS232 communication

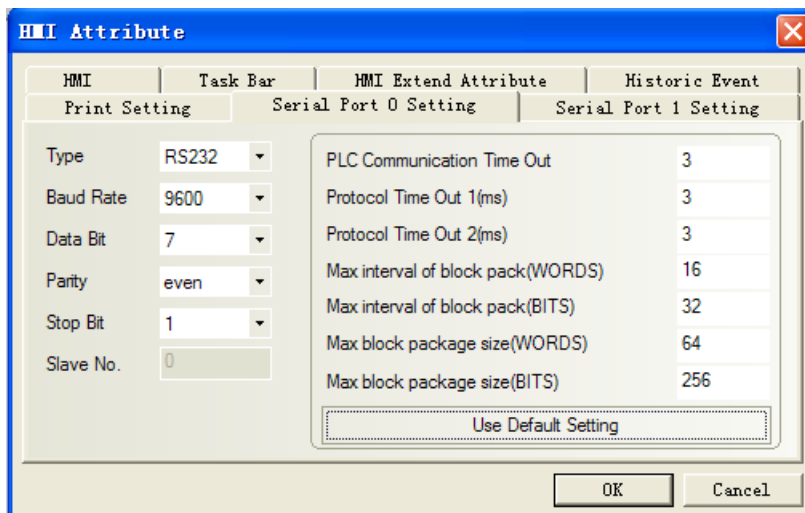

FBS-CB25-3 module RS485 communication

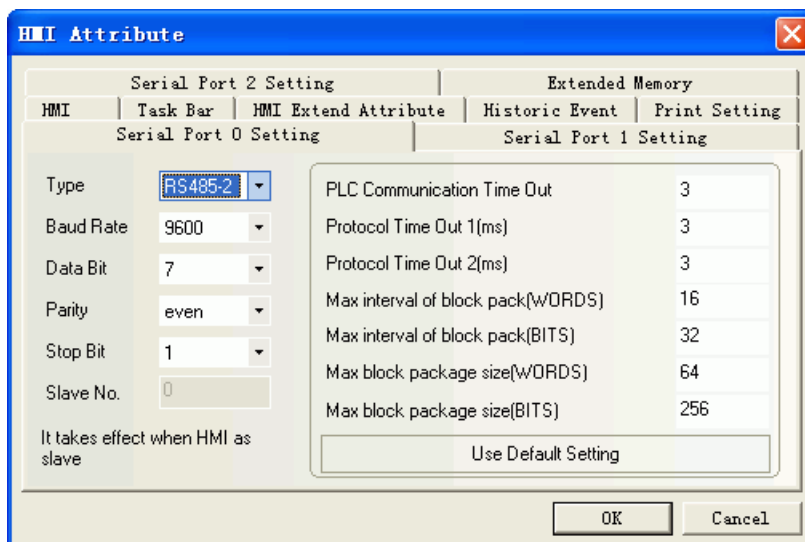

FBS-CB25-3 module communication  
Modbus RTU RS232 communication

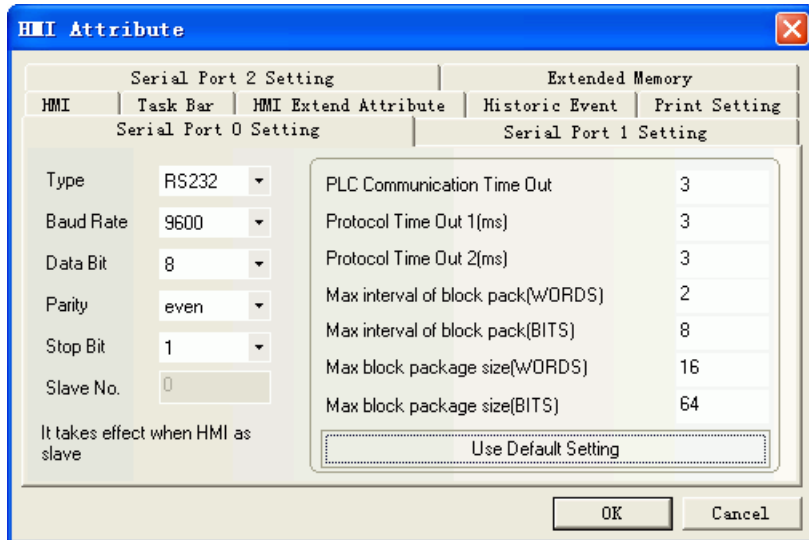

**Modbus RTU RS485 communication**

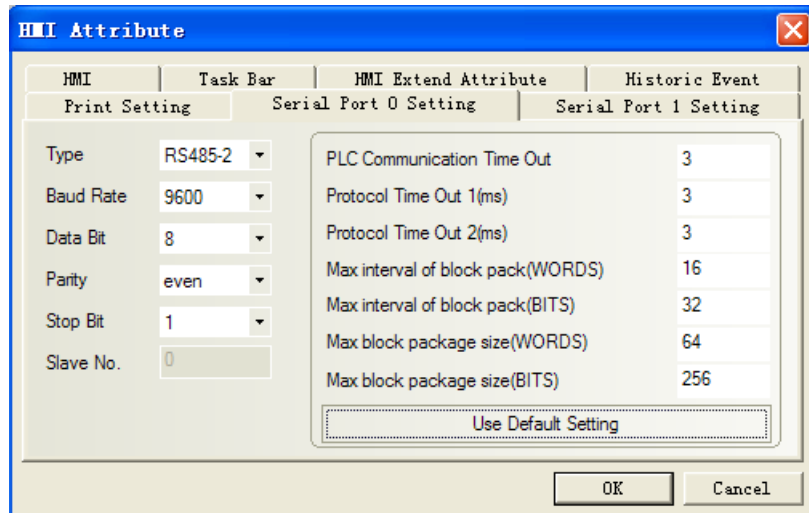

**Note:** The detailed communication configuration must be the same as the PLC's port setting.

**© Network Communication Setting**

**HMI Setting**

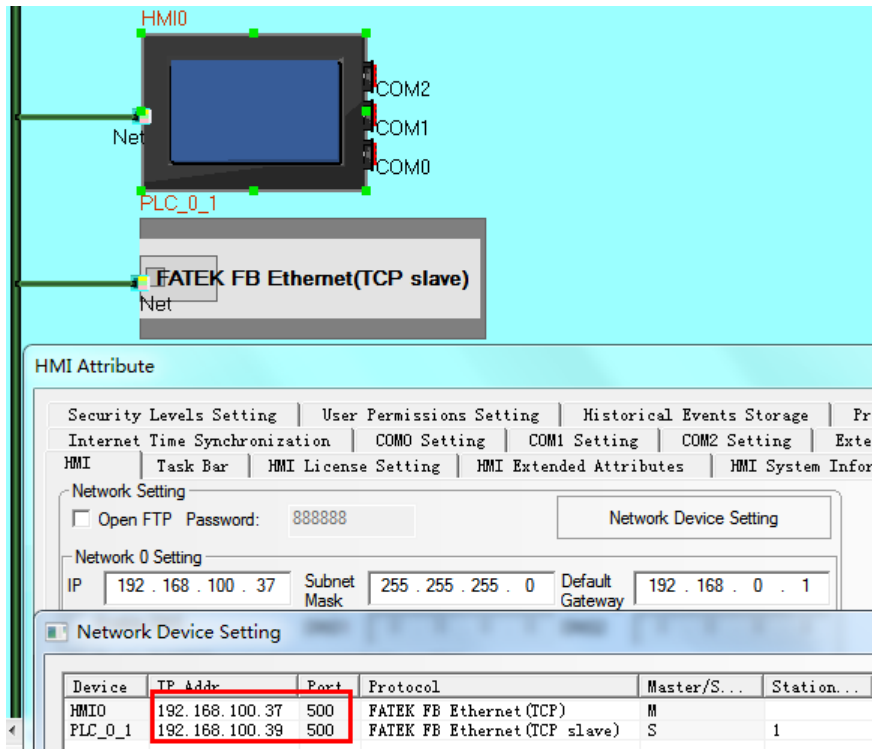

### PLC Setting

1. In ether cfg software, click [scan] to search the PLC information.

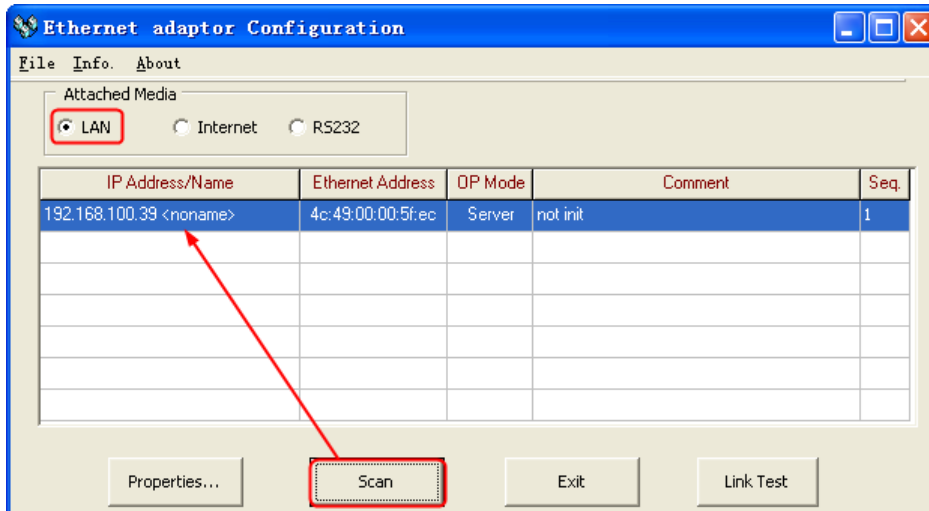

2. Click [Properties] to change the IP and ports.

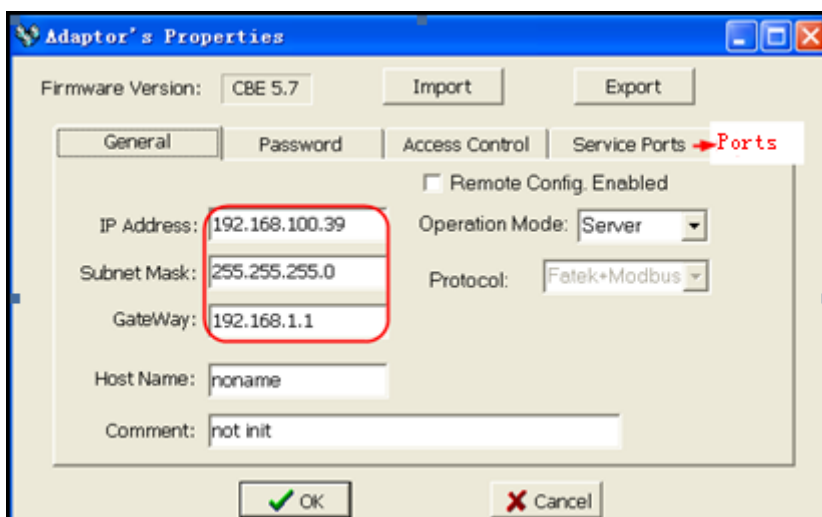

- 3、 Click [ok] to save the settings.

### ◎ Supported Device

Device	Bit Address	Word Address	Format	Notes
Input	X0-9999	-----	DDDD	
Output	Y0-9999	-----	DDDD	
Internal Relay	M0-9999	-----	DDDD	
Step Relay	S0-9999	-----	DDDD	
Timer Relay	T0-9999	-----	DDDD	
Counter Relay	C0-9999	-----	DDDD	
Data Register	-----	R-L 0-3839	DDDD	
Data Register	-----	R-H 3840-9999	DDDD	
Data Register	-----	D0-9999	DDDD	
Timer	-----	T0-9999	DDDD	
Counter	-----	C0-199	DDD	
Double word Counter Register	-----	DRC200-255	DDD	

**Note:** R-L register corresponds to the “R” register of the PLC, the address range 0~3839;  
R-H register corresponds to the “R” register of the PLC, the address range 3840~9999;  
DR register corresponds to the “D” register of the PLC;  
TMR register corresponds to the “T” register of the PLC;  
CTR register corresponds to the “C” register of the PLC;  
DRC register corresponds to the “C(32)” register of the PLC, e.g.: DRC200==C200

### ◎ Cable Diagram

#### FB RS232 communication cable

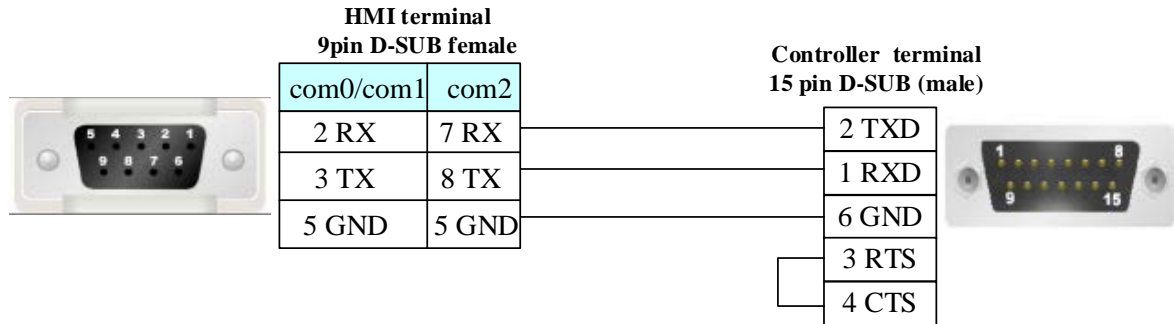
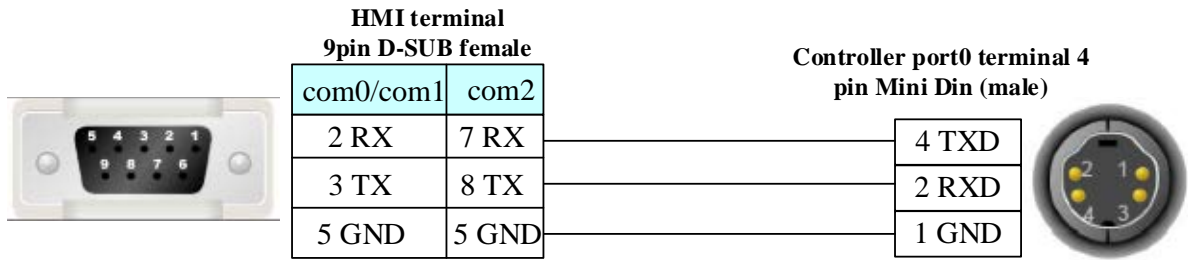

### FBS-CB25-3 module communication

### RS232 communication cable

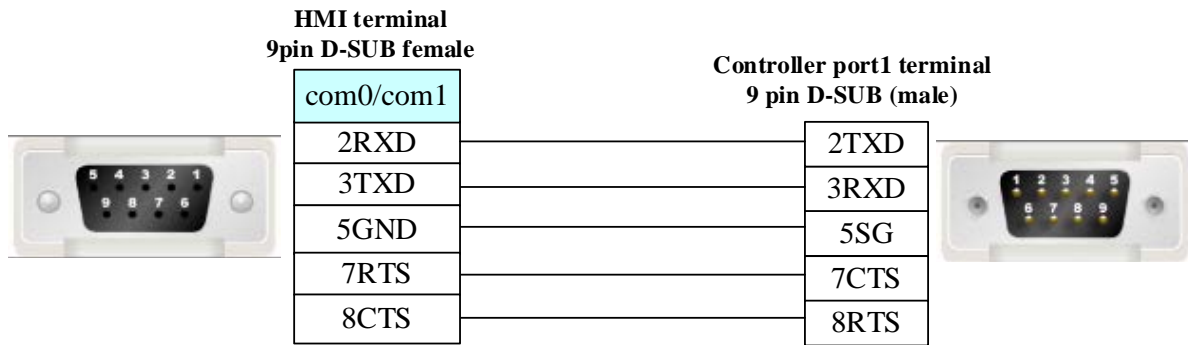

### RS485 communication cable

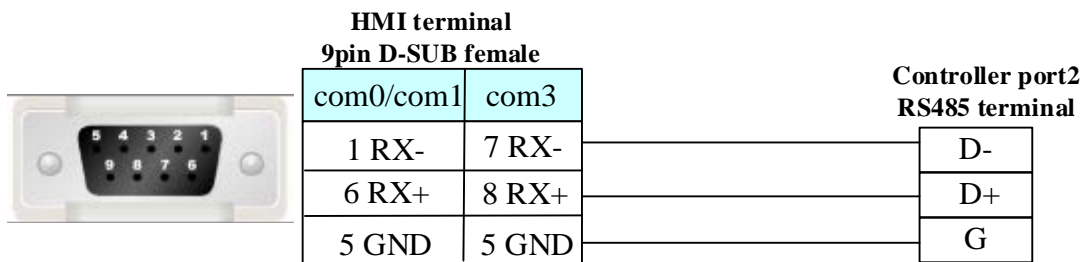

### Ethernet cable

Connecting PC and HMI use cross-ruling; communicating with hub or switch use cross-over cable or cross-ruling.

Refer to [3.3 Download by Network Ethernet](#) for method of making connection cable.



## 4.25 Fuji SPB

### ◎ Serial Communication

Series	CPU	Link Module	Driver
SPB	NWOP20T-31	RS485 interface on the CPU	Fuji SPB
NB	NB2U24R-11	RS485 interface on the CPU	

### ◎ System configuration

Series	CPU	Link Module	Ethernet Type	Parameter	Cable
SPB	NWOP20T-31	RS485 interface on the CPU	RS422	<a href="#">Setting</a>	<a href="#">Your owner</a>
NB	NB2U24R-11	RS485 interface on the CPU	RS422		<a href="#">cable</a>

### ◎ Communication Setting

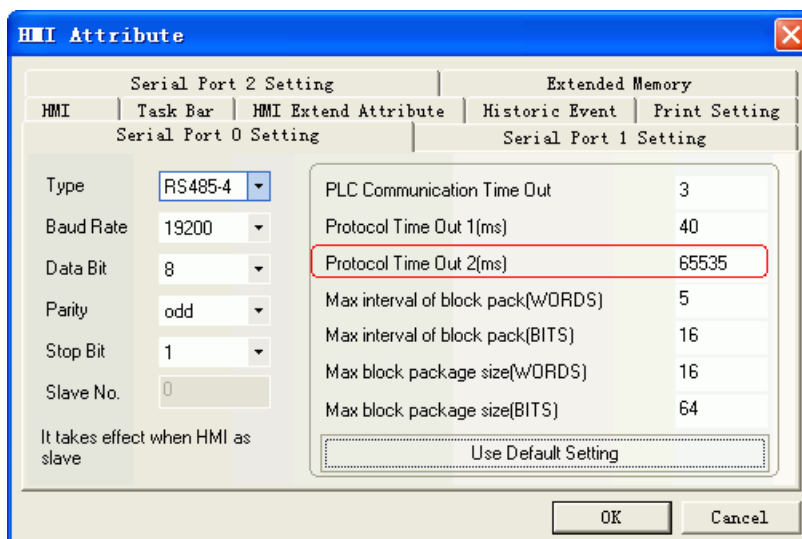

**NOTE:** When PLC is protected by password, protocol time out 2 is 65535, and the register is read only. If you want to make the register writable, you must let the protocol time out 2 equal the PLC password.

Example: PLC password is 1234, and then you make the protocol time out 2 to be 1234.

PLC password is 0010, and then you make the protocol time out 2 to be 10.

### ◎ Supported Device

#### SPB

Device	Bit Address	Word Address	Format	Notes
Data register	D 0~6FF.F	-----	HHH.H	
Special relay	M_special 0~1FF	-----	HHH	
Counter contact	C 0~FF	-----	HH	
Timer contact	T 0~1FF	-----	HHH	
Keep relay	L 0~FFF	-----	HHH	
Auxiliary relay	M 0~FFF	-----	HHH	
Output relay	Y 0~3FF	-----	HHH	
Input relay	X 0~3FF	-----	HHH	

Timer contact	-----	TW 0~3FF	HHH	
Counter contac	-----	CW 0~FF	HH	
Data register	-----	DW 0~6FF	HHH	
Special register	-----	DW_special 0~1FF	HHH	
Link register(0 slot)	-----	W0 0~7FF	HH	
Link register(1 slot)	-----	W1 0~7FF	HHH	
Link register(2 slot)	-----	W2 0~7FF	HHH	
Link register(3 slot)	-----	W3 0~7FF	HHH	
Link register(4 slot)	-----	W4 0~7FF	HHH	
Link register(5 slot)	-----	W5 0~7FF	HHH	
Link register(6 slot)	-----	W6 0~7FF	HHH	
Link register(7 slot)	-----	W7 0~7FF	HHH	

**Note:** M\_special address: 8000 in the PLC corresponds to 0 in the HMI.

DW\_special address: 8000 in the PLC corresponds to 0 in the HMI.

### NB

Device	Bit Address	Word Address	Format	Notes
Data register	D 0~3F.F	-----	HHH.H	
Special relay	M_special 0~1FF	-----	HHH	
Counter contact	C 0~1F	-----	HH	
Timer contact	T 0~1F	-----	HHH	
Keep relay	L 0~1FF	-----	HHH	
Auxiliary relay	M 0~3FF	-----	HHH	
Output relay	Y 0~3F	-----	HHH	
Input relay	X 0~3F	-----	HHH	Read only
Timer contact	-----	TW 0~1F	HHH	
Counter contact	-----	CW 0~1F	HH	
Data register	-----	DW 0~3F	HHH	
Special register	-----	DW_special 0~1FF	HHH	

### © Cable Diagram

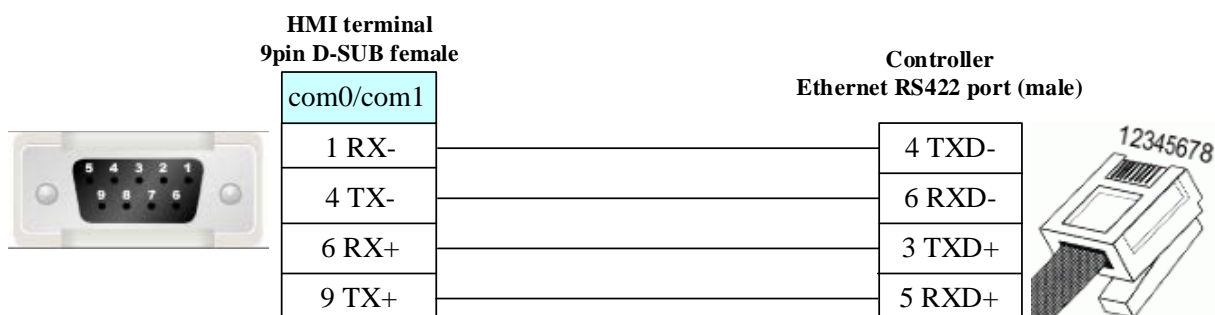

## 4.26 GE Fanuc Automation Inc.

### ◎ Serial Communication

Series	CPU	Link Module	Driver
GE Fanuc Series 90-30	IC693CPU311/313	Serial Connector on Power Supply	GE Fanuc Series SNP
	IC693CPU321/323		
	IC693CPU331		
	IC693CPU340/341		
	IC693CPU350/351/352		
	IC693CPU360/363/364		
	IC693CPU374		
	IC693CSE311		
	IC693CSE313		
	IC693CSE323		
IC693CSE331			
IC693CSE340			
GE Fanuc Series 90-30	IC693CPU311/313	Connector on Power Supply	GE SNP-X
	IC693CPU321/323	IC693CMM311	
	IC693CPU331		
	IC693CPU340/341		
	IC693CPU350		
	IC693CPU360/364		
	IC693CPU351	Connector on Power Supply	
	IC693CPU352	Port1 on CPU unit	
	IC693CPU363	Port2 on CPU unit	
	IC693CPU374	IC693CMM311	
IC693CMM311			
VersaMax Series	CPU001/002/005	RS232 on port1	
	CPUE05	RS485 on port2	
VersaMax Micro & Nano Series	IC200UAL004/005/006	RS232 on port1	
	IC200UDD110/120/212		
	IC200UDR005/006/010		
	IC200UAA007	RS485 on port2	
	IC200UAR028		
PACSystems RX3i	IC695CPE310	RS232 on port1	GE Fanuc Series SNP
	IC695CPE320	RS485 on port2	

### ◎ Network communication

Series	CPU	Link Module	Driver
Series90-30	CPU340/341 CPU350/351/352	IC693CMM321	GE IP Ethernet (TCP Slave)

	CPU360/363 CSE311 CSE313 CSE323 CSE331 CSE340		
	CPU364 CPU374	Ethernet interface on CPU	
PACSystem RX3i	IC695CPE305 IC695CPE310 IC695CPE 315 IC695CPE 320	IC695ETM001	
VersMax Micro&Nano	IC200UDD020 IC200UDD040 IC200UDD064 IC200UDD120 IC200UDD164 IC200UDD220 IC200UDD240 IC200UDR020 IC200UDR040 IC200UDR064 IC200UDR120 IC200UDR140 IC200UDR164 IC200UDR440	IC200UEM001	
VerMax	CPUE05	Ethernet interface on CPU	
Series 90-30	CPU311/313 CPU323 CPU331 CPU340/341 CPU350/351/352 CPU360/363 CSE311 CSE313 CSE323 CSE331 CSE340	IC693CMM321	Modbus TCP
	CPU364	Ethernet interface on CPU	

	CPU374		
Series 90-70	CPU731 CPU771 CPU772 CPU780 CPU781 CPU782 CPU788 CPU789 CPM790 CPM915 CPM925 CSE784 CSE924 CSE925 CPX772 CPX782 CPX928 CPX935 CGR772 CGR935	IC697CMM742 (Type2)	
PACSystem RX7i	CPE010 CPE020 CRE020	Ethernet interface on CPU	

### ◎ Serial System configuration

Series	CPU	Link Module	COMM Type	Parameter	Cable
GE Fanuc Series 90-30	IC693CPU374	RS485 on the CPU unit	RS232	<a href="#">Setting</a>	<a href="#">Your owner cable</a>
			RS422	<a href="#">Setting</a>	<a href="#">Your owner cable</a>
		IC693CMM311	RS232	<a href="#">Setting</a>	<a href="#">Your owner cable</a>
			RS422	<a href="#">Setting</a>	<a href="#">Your owner cable</a>
VersaMax Series	CPU001/002/005 CPUE05	RS232 on port1	RS232	<a href="#">Setting</a>	<a href="#">Your owner cable</a>
		RS485 on port2	RS422	<a href="#">Setting</a>	<a href="#">Your owner cable</a>
VersaMax Micro & Nano Series	IC200UAL004/005/006 IC200UDD110/120/212 IC200UDR005/006/010 IC200UAA007 IC200UAR028	RS232 on port1	RS232	<a href="#">Setting</a>	<a href="#">Your owner cable</a>
		RS485 on port2	RS422	<a href="#">Setting</a>	<a href="#">Your owner cable</a>
PACSystems RX3i	IC695CPE310 IC695CPE320	RS232 on port1	RS232	<a href="#">Setting</a>	<a href="#">Your owner cable</a>
		RS485 on port2	RS422	<a href="#">Setting</a>	<a href="#">Your owner cable</a>

### ◎ Network System configuration

Series	Connect Type	Parameter	Cable
--------	--------------	-----------	-------

Series 90-30/ Versamax/ PACSystem RX3i/ Versamax Mico&Nano	Ethernet (GE IP Ethernet(TCP Slave))	<a href="#">Setting</a>	<a href="#">Your owner cable</a>
Series 90-30/ PACSystem RX3i/ Versamax Mico&Nano	Ethernet (Modbus TCP Slave)	<a href="#">Setting</a>	

### ◎ Serial Communication Setting

#### GE Fanuc Series SNP RS232 Communication

#### GE Fanuc Series SNP RS422 Communication

#### GE SNP-X Protocol RS232 Communication

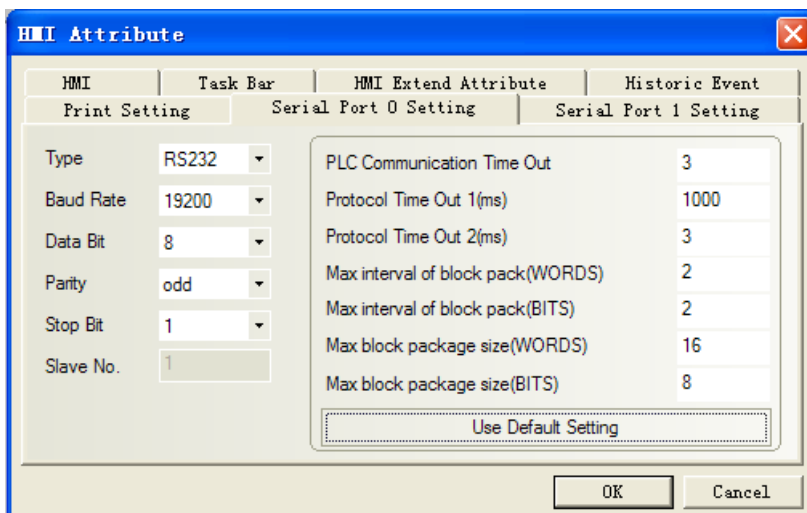

### GE SNP-X Protocol RS422 Communication

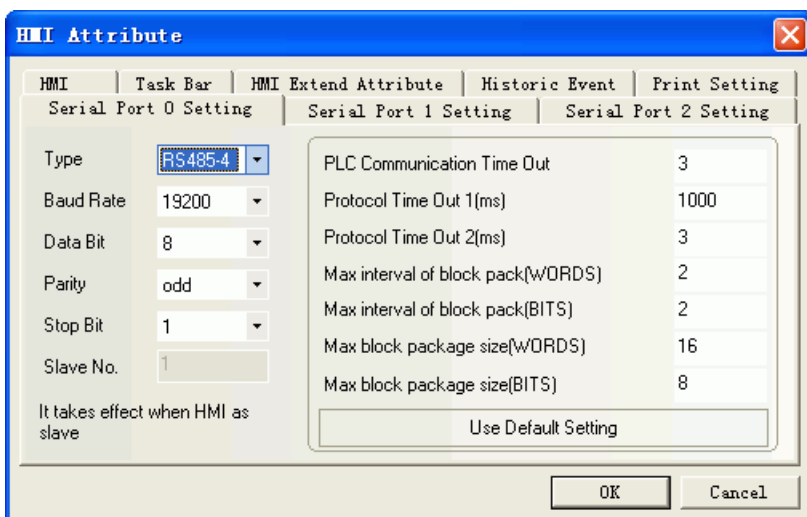

**NOTE:** Set matching communication parameter in the Programming software.

### PLC Setting

Parameters	Values
I/O Scan-Stop:	No
Power Up Mode:	Last
Logic / Configuration From:	RAM
Registers:	RAM
Passwords:	Enabled
Checksum Words:	8
Default Modem Turnaround Time (.01	0
Default Idle Time (Sec):	10
SNP ID:	1
Switch Run / Stop:	Enabled
Switch Memory Protect:	Disabled
Diagnostics:	Enabled
Fatal Fault Override:	Disabled

Parameters	Values
Port Mode:	SNP
Port Type:	Slave
Data Rate (bps):	19200
Parity:	Odd
Stop Bits:	1
Timeout:	Long
Turnaround Delay (mSec in 10 mSec)	0
SNP ID:	1

**RX3i 设置:**

Parameters		Values
Port Mode		SNP Slave
Data Rate		19.2k Baud
Parity		Odd
Stop bits		1
Physical Interface		2-wire
Turn Around Delay Time (ms)		0
Timeout (s)		60
SNP ID		1
Specify stop mode		No

Parameters		Values
Port Mode		SNP Slave
Data Rate		19.2k Baud
Parity		Odd
Stop bits		1
Physical Interface		4-wire Transmitter On
Turn Around Delay Time (ms)		0
Timeout (s)		60
SNP ID		1
Specify stop mode		No

### ◎ Network Communication Setting

MODBUS TCP Protocol:

HMI:

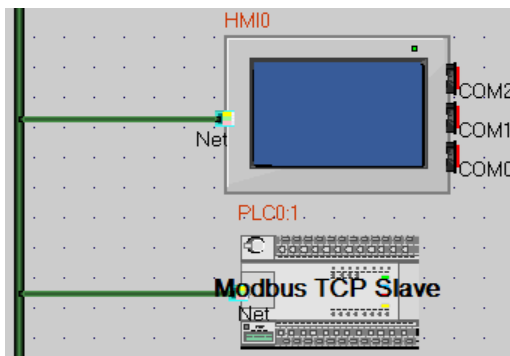

Device	IP Addr	Port	Protocol	Master/...	State...	Virtual
HMI0	192.168.0.253	502	Modbus TCP	M		
PLC0	192.168.0.10	502	Modbus TCP Slave	S	1	

Buttons: Add, Delete, Delete All, Modify, OK

PLC:



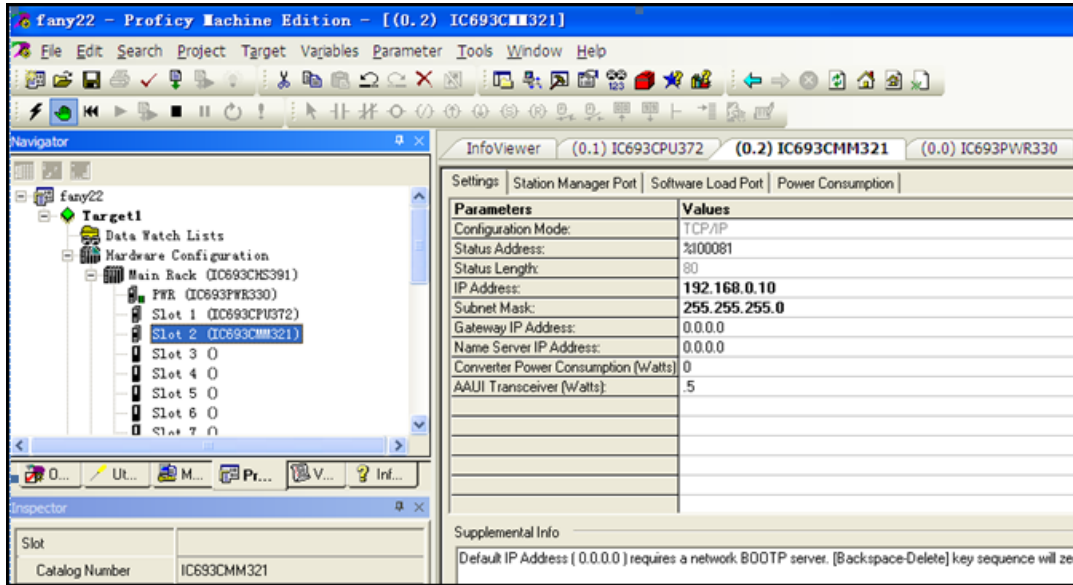

GE IP Ethernet (TCP Slave) Protocol:  
HMI:

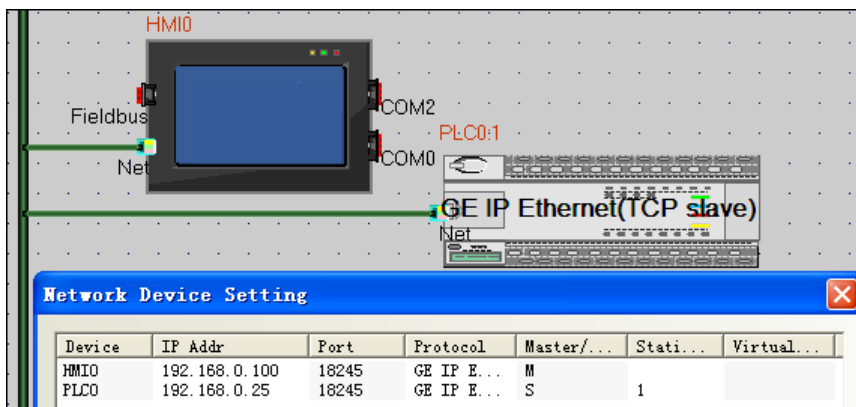

PLC:

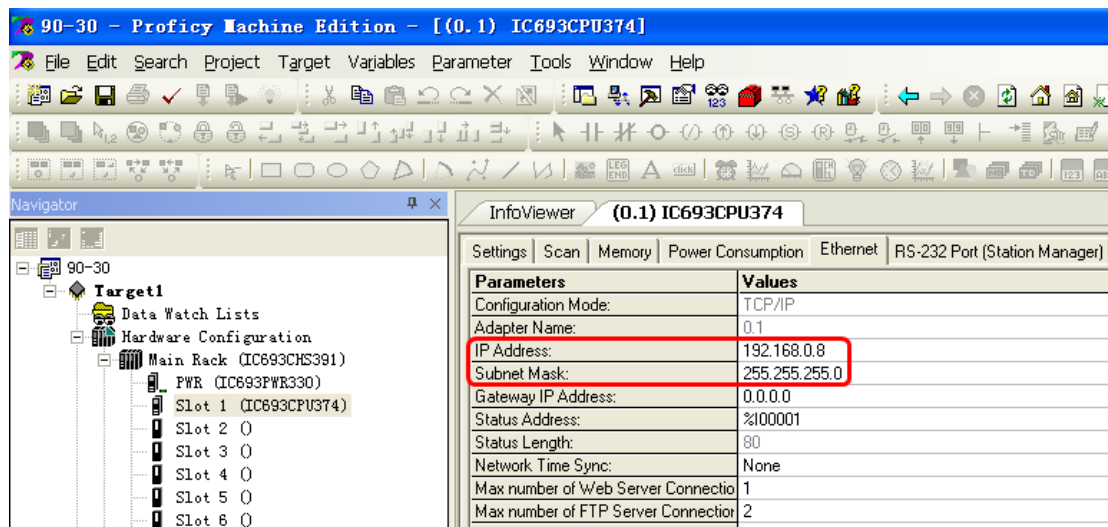

© Supported Device

**GE Fanuc Series SNP**

Device	Bit Address	Word Address	Format	Notes
System	SC 01-128	-----	DDD	
System	SB 01-128	-----	DDD	
System	SA 01-128	-----	DDD	
System	S 01-128	-----	DDD	
Temporary	T 001-256	-----	DDD	
Internal	M 0001-12288	-----	DDDDD	
Genius Global	G 0001-7680	-----	DDDD	
Output	Q 0001-12288	-----	DDDDD	
Input	I 0001-12288	-----	DDDD	
Analog Output	-----	AQ 001-32640	DDDD	
Analog Input	-----	AI 001-32640	DDDDD	
Register	-----	R 001-32640	DDDDD	

**GE SNP-X**

Device	Bit Address	Word Address	Format	Notes
System	SC 01-9999	-----	DDDD	
System	SB 01-9999	-----	DDDD	
System	SA 01-9999	-----	DDDD	
System	S 01-9999	-----	DDDD	
Temporary	T 001-9999	-----	DDDD	
Internal	M 0001-9999	-----	DDDD	
Genius Global	G 0001-9999	-----	DDDD	
Output	Q 0001-9999	-----	DDDD	
Input	I 001-9999	-----	DDDD	
Analog Output	-----	AQ 001-9999	DDDD	
Analog Input	-----	AI 0001-9999	DDDD	
Register	-----	R 0001-99999	DDDD	

**Address correspondence between modbus**

Modbus Register	Start Address	End Address	PLC Memory Address	Length
0xxxx - Coil Table	1	32768	%Q00001	32768
1xxxx - Discrete Inputs Table	1	32768	%I00001	32768
3xxxx - Input Register Table	1	64	%AI00001	64
4xxxx - Holding Register Table	1	1024	%R00001	1024
6xxxx - Internal Tables	0	0	%W00001	0

**GE IP Ethernet (TCP Slave)**

Device	Bit Address	Word Address	Format	Note
System	S_B 0-127	----	DDD	
System	SA_B 0-127	----	DDD	

System	SB_B 0-127	----	DDD	
System	SC_B 0-127	----	DDD	
Input	I_B 0-32767	----	DDDDD	
Output	Q_B 0-32767	----	DDDDD	
Internal	M_B 0-32767	----	DDDDD	
Temporary	T_B 0-1023	----	DDDD	
Genius Global	G_B 0-7679	----	DDDD	
Analog Input	----	AI 0-2047	DDDD	
Analog Output	----	AQ 0-511	DDD	
Register	----	R 0-32639	DDDDD	
System	----	S 0-7	D	
System	----	SA 0-7	D	
System	----	SB 0-7	D	
System	----	SC 0-7	D	
Input	----	I 0-2047	DDDD	
Output	----	Q 0-2047	DDDD	
Internal	----	M 0-2047	DDDD	
Temporary	----	T 0-63	DD	
Genius Global	----	G 0-479	DDD	

**NOTE:** In HMI, the first address is 0, but in PLC is 1

### ◎ Cable Diagram

#### 90-30/VersaMax/RXi RS232 communication

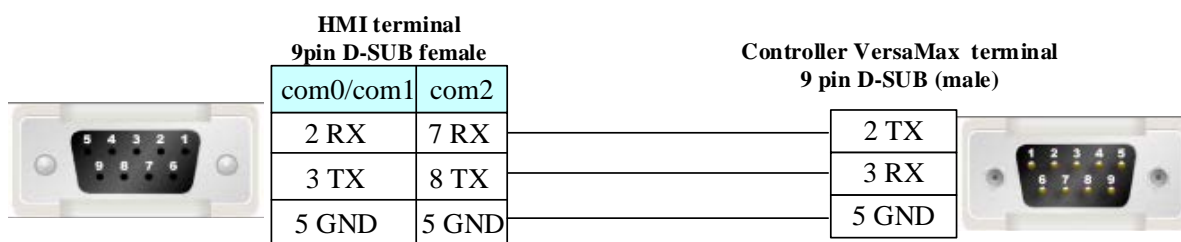

#### VersaMax Micro & Nano Series RS232 communication

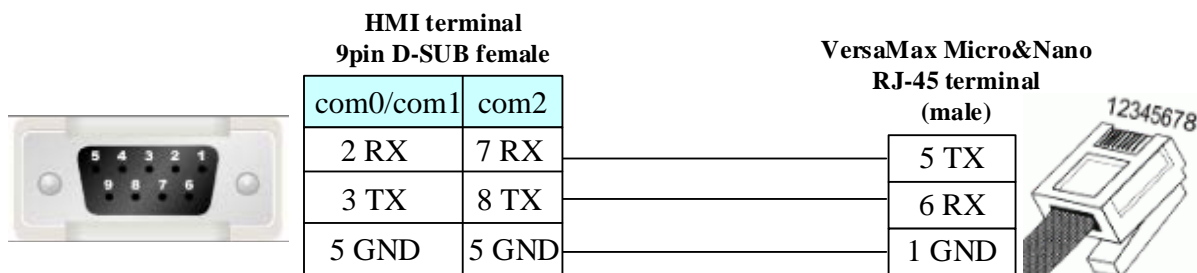

### CMM311 RS232 communication

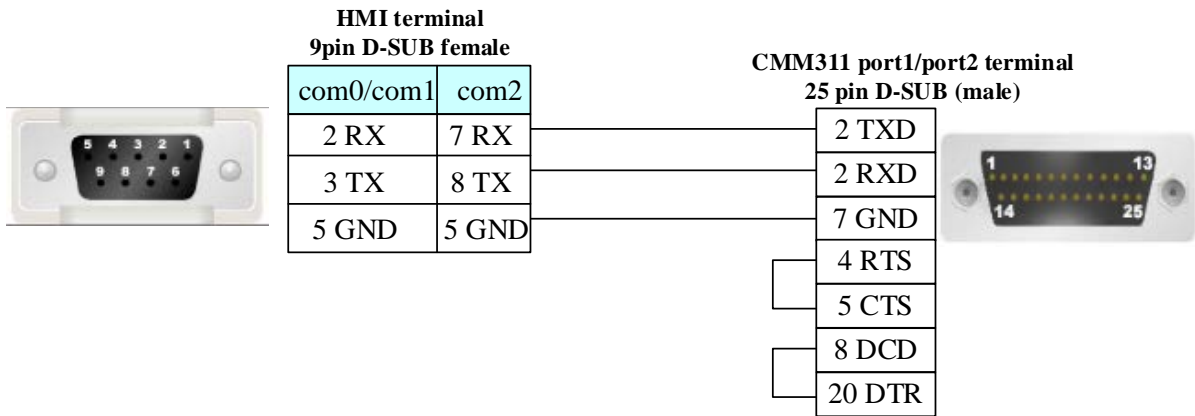

### CMM311 RS422 communication

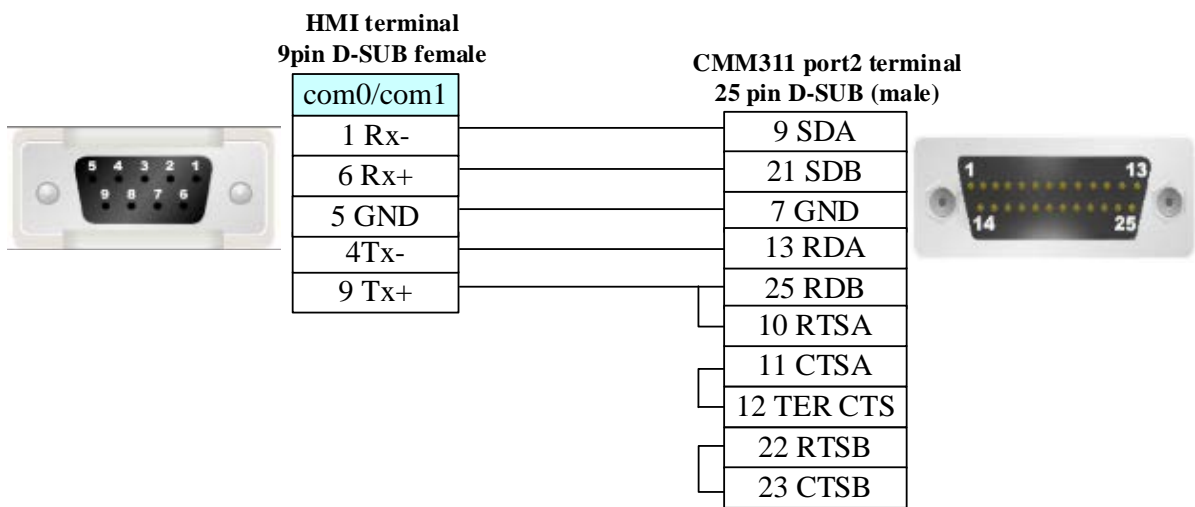

### 90-30/VersaMax RS422 communication

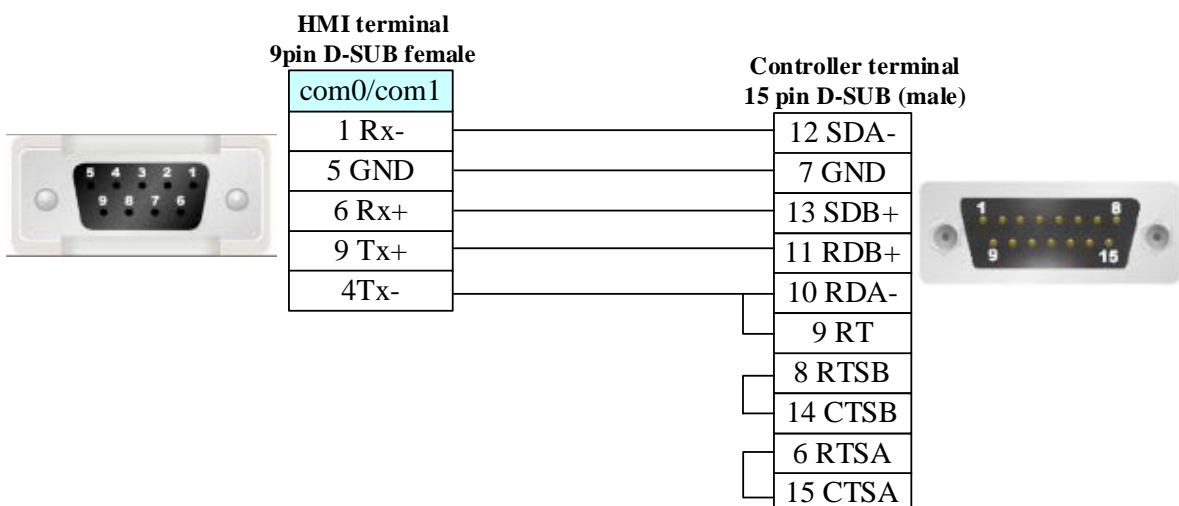

### Ethernet communication protocol cable

Cross-connection or crossover network cable can be used as communication cable via the hub  
Refer to [3.3 Download by Network Ethernet](#) for method of making connection cable.

## 4.27 HAIWELL

### ◎Serial Communication

Series	CPU	Link Module	Driver
E/S	HW-S16ZA220R	RS232 on com1	Haiwell
		RS485 on com2	

### ◎System configuration

Series	CPU	Link Module	COM Type	Parameter	Cable
E/S	HW-S16ZA220R	RS232 on com1	RS232	<a href="#">Setting</a>	<a href="#">Your owner cable</a>
		RS485 on com2	RS485	<a href="#">Setting</a>	<a href="#">Your owner cable</a>

### ◎Communication Setting

#### Haiwell RS232 communication

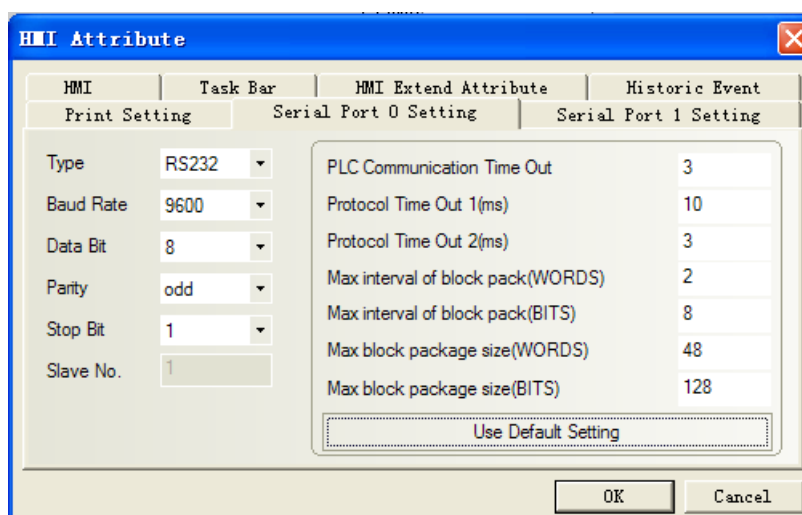

#### Haiwell RS485 communication

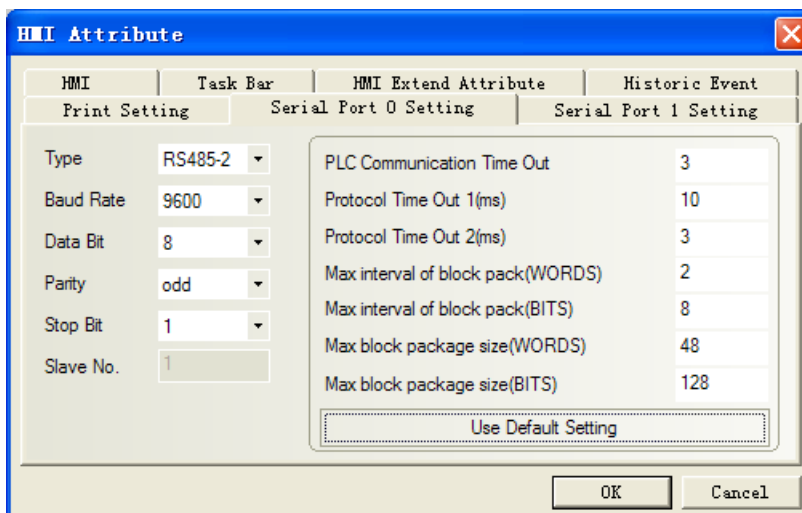

### ◎ Supported Device

Device	Bit Address	Word Address	Format
Special memory Relay	SM0 – 99999	-----	DDD
Counter Relay	C0 – 99999	-----	DDD
Timer Relay	T0 – 99999	-----	DDD
Internal Relay	M0 – 99999	-----	DDDD
Switch Output	Y0 – 99999	-----	DDD
Switch Input	X0 – 99999	-----	DDD
System register	-----	SV0-9999	DDD
Counter(Current Value)	-----	CCV_16 0-9999	DDD
Counter(Current Value double word)	-----	CCV_32 48-79	DD
Timer(Current Value)	-----	TCV0-9999	DDD
Internal Register	-----	V0-9999	DDDD
Analog Output	-----	AQ0-9999	DD
Analog Input	-----	AI0-9999	DD

### ◎ Cable Diagram

#### Haiwell RS232 communication cable

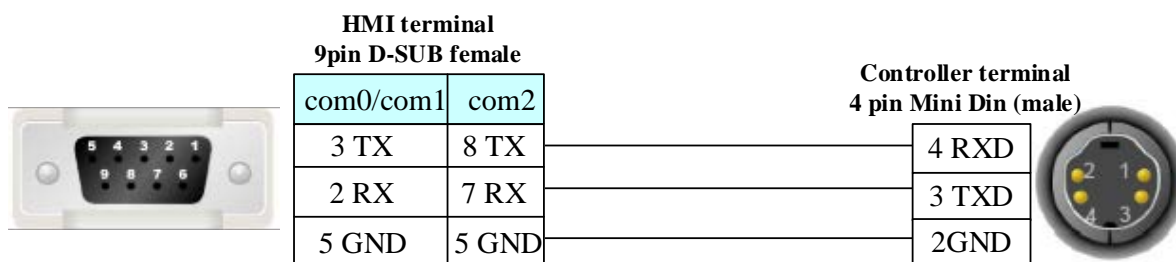

#### Haiwell RS485 communication cable

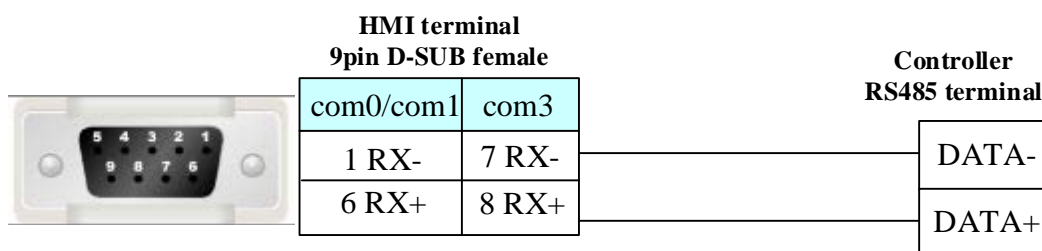

## 4.28 HanG

### ◎ Serial Communication

Series	CPU	Link Module	Driver
--------	-----	-------------	--------

HanG	DTS3338	RS485 on the CPU unit	HanG
------	---------	-----------------------	------

◎ System configuration

Series	CPU	Link Module	COMM Type	Parameter	Cable
HanG	DTS3338	RS485 on the CPU unit	RS485	<a href="#">Setting</a>	<a href="#">Your owner cable</a>

◎ Communication Setting

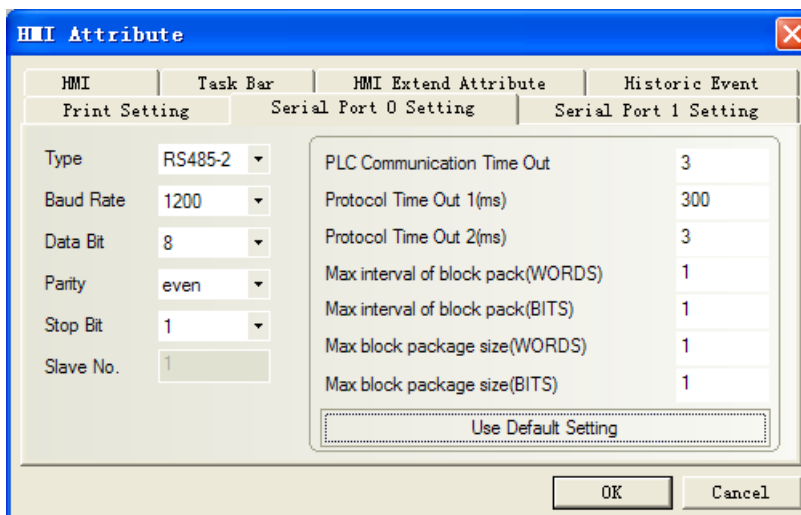

◎ Supported Device

Device	Bit Address	Word Address	Format	Notes
Password	-----	APAS 0	H	
Meter Number	-----	ANUM C032	HHHH	
Init Meter	-----	ASTR 0	H	
Register value	-----	AMVD 9010	HHHH	

**NOTE:** Use text part to show meter number (ANUM). AMVD data type: signed integer

◎ Cable Diagram

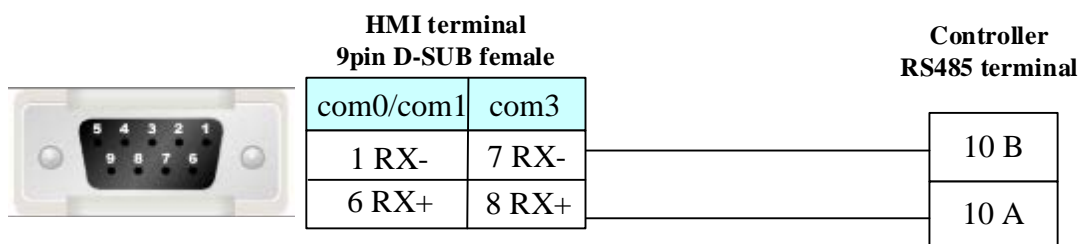

4.29 Hitachi Inverter

◎ Serial Communication

Series	CPU	Link Module	Driver
--------	-----	-------------	--------

Hitachi Inverter	SJ300	RS485	Hitachi SJ300
------------------	-------	-------	---------------

### ◎ System configuration

Series	CPU	Link Module	Parameter	Cable
Hitachi Inverter	SJ300	RS485	<a href="#">Setting</a>	<a href="#">Your owner cable</a>

### ◎ Communication Setting

HMI default communication parameter: 4800, 7, none, 1; station: 1

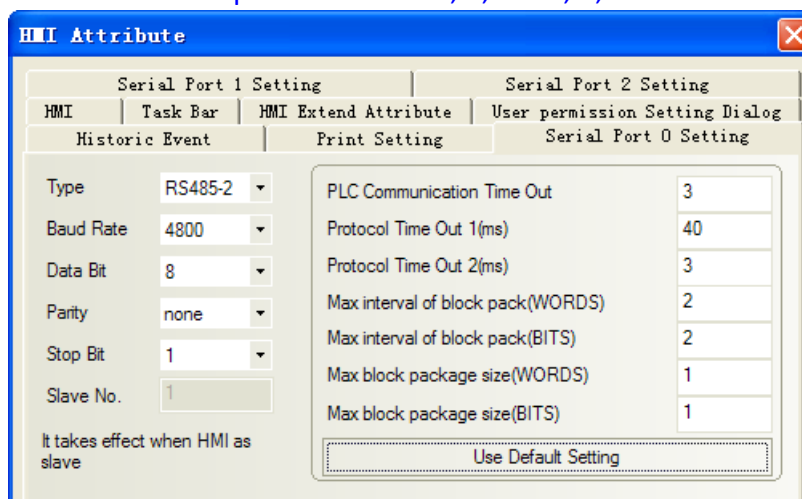

### Inverter internal setting

Code	Name	description
A001	Frequency set	00(VR)/01(Terminal)/02(operator)/03(RS485)/04(OPT 1)/05(OPT 2)
A002	Run set	01(Terminal)/02(operator)/03(RS485) /04(OPT 1)/05(OPT 2)
C71	Baudrate	02(close loop detect)/ 03(2400bps)/ 04(4800bps)/ 05(9600bps)/ 06(19200bps)
C72	Station set	1~32
C73	Data bit	7(7 bit)/8(8 bit)
C74	Parity	00(none)/01(even)/02(odd)
C75	Stop bit	1(bit)/2(bit)

**NOTE:** A001, A002 must be set 03 (RS485) in order to communication with HMI.

### ◎ Supported Device

Device	Bit Address	Word Address	Format	Notes
	-----	P Extend Func 0~50	DD	
	-----	H Extend Func 0~512	DDD	
	-----	F Func Date 0~65535	DDDDD	
	-----	C Func Date 0~65535	DDDD	
	-----	B Func Date 0~999	DDD	
	-----	A Func Date 0~999	DDD	
FWD/REW/STOP		(00)FWD/REW/STOP 0	D	Write only
FREQ SET	-----	(01)FREQ SET 0	D	Write only



TerminalPoint State		(02)TerminalPoint State 0~7	D	Write only
Surveillance Data	-----	(03)Surveillance Data 0~12	DD	Read only
Transducer State		(04)Transducer State 0~3	D	Read only
Trip Record	-----	(05)Trip Record 0~54	DD	Read only
Revert	-----	(08)Revert 0	D	Write only
Recount Motor Con	-----	(0B)Recount Motor Cons 0	D	Write only
Store EEPROM	-----	Store EEPROM 0	D	

**NOTE:** (02)Terminal Point State 0~7 use text part

### ◎ Cable Diagram

#### RS485 communication cable

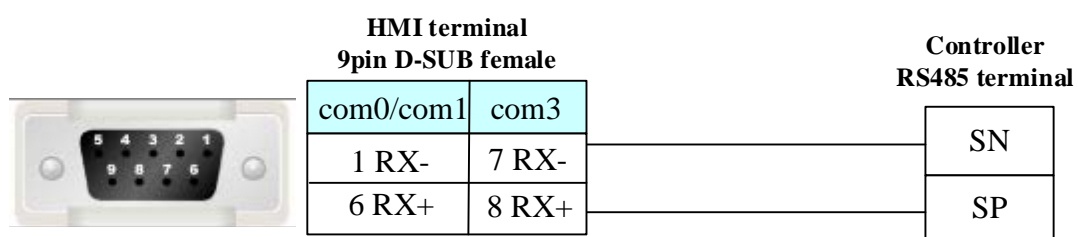

## 4.30 Hitachi IES Co., Ltd

### ◎ Serial Communication

Series	CPU	Link Module	Driver
H	H-20	port on CPU	Hitachi
	H-28		
	H-40		
	H-64		
	H-200(CPU-02H)		
	H-250(CPU21-02H)		
	H-252B(CPU22-02HB)		
	H-252C(CPU22-02HC)		
	H-300(CPU-03Ha)		
	H-302(CPU2-03H)		
	H-700(CPU-07Ha)		
	H-702(CPU2-07H)		
	H-2000(CPU-20Ha)		
	H-2002(CPU2-20H)		
H-4010(CPU3-40H)			
H-1002(CPU2-10H)			
H-300(CPU-03Ha)	COMM-H	Hitachi	
H-302(CPU2-03H)	COMM-2H		

	H-700(CPU-07Ha) H-702(CPU2-07H) H-2000(CPU-20Ha) H-2002(CPU2-20H) H-4010(CPU3-40H)		
	H-1002(CPU2-10H)	COMM-2H	
EH-150	EH-150(EH-CPU104) EH-150(EH-CPU104A) EH-150(EH-CPU208) EH-150(EH-CPU208A) EH-150(EH-CPU308) EH-150(EH-CPU308A) EH-150(EH-CPU316) EH-150(EH-CPU316A) EH-150(EH-CPU448) EH-150(EH-CPU448A) EH-150(EH-CPU516) EH-150(EH-CPU548)	Serial port 1 on CPU Serial port 2 on CPU	
	EH-150(EH-CPU516) EH-150(EH-CPU548)	Port 1 on EH-SIO Port 2 on EH-SIO	
MICRO-EH	MICRO-EH(EH-D10□□□) MICRO-EH(EH-A14□□□) MICRO-EH(EH-D14□□□) MICRO-EH(EH-A23□□□) MICRO-EH(EH-D23□□□) MICRO-EH(EH-A28□□□) MICRO-EH(EH-D28□□□)	Port 1 on CPU	
	MICRO-EH(EH-A23□□□) MICRO-EH(EH-D23□□□) MICRO-EH(EH-A28□□□) MICRO-EH(EH-D28□□□)	Port 2 on CPU	
	MICRO-EH(EH-A64□□□) MICRO-EH(EH-D64□□□) MICRO-EH(EH-A40□□□) MICRO-EH(EH-D40□□□) MICRO-EH(EH-A20□□□) MICRO-EH(EH-D20□□□)	Port on CPU  EH-OB232 EH-OB485	

### ◎ Ethernet Communication

Series	CPU	Link Module	Driver
S10V	LQP510-Z	LQP520-Z	HITACHI S10V Series Ethernet (TCP Slave)
EHV	EHV-CPU32	Ethernet interface on CPU	HITACHI EHV Series Ethernet (TCP Slave)

### ◎ Serial System configuration

Series	CPU	Link Module	COMM Type	Parameter	Cable
H	H-20	RS232 on the CPU unit	<a href="#">RS232</a>	<a href="#">Setting</a>	<a href="#">Your owner cable</a>
MICRO-EH	EH-A23DR	Port 1 on CPU	<a href="#">RS232</a>	<a href="#">Setting</a>	<a href="#">Your owner cable</a>
		Port 2 on CPU	<a href="#">RS485</a>	<a href="#">Setting</a>	<a href="#">Your owner cable</a>

### ◎ Ethernet System Communication

Series	CPU	Link Module	Connect Type	Parameter	Cable
S10V	LQP510-Z	LQP520-Z	Ethernet	<a href="#">Setting</a>	<a href="#">Your owner cable</a>
EHV	EHV-CPU32	Ethernet interface on CPU	Ethernet	<a href="#">Setting</a>	

### ◎ Serial Communication Setting

#### RS232 communication

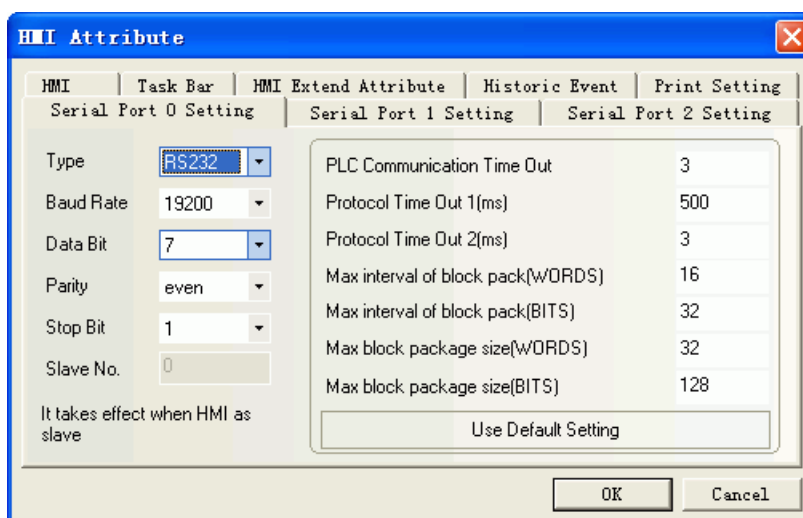

#### RS422 communication

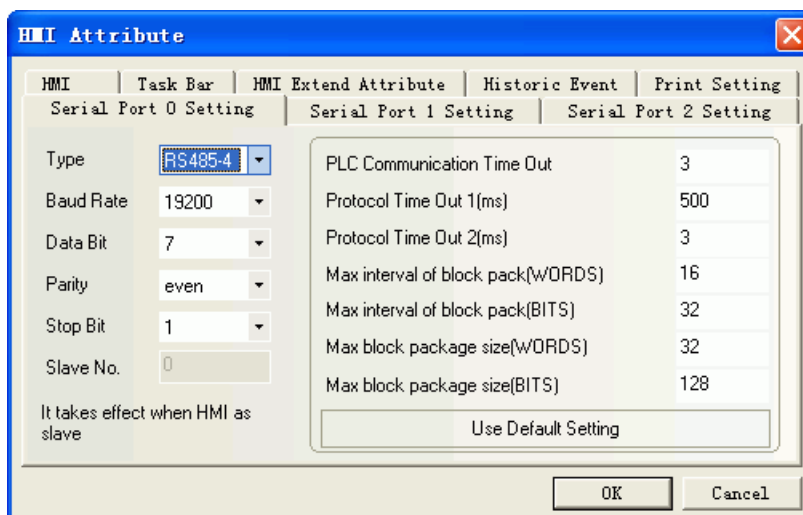

### Ethernet Communication Setting

#### HITACHI S10V Series Ethernet (TCP Slave)

#### HMI Setting

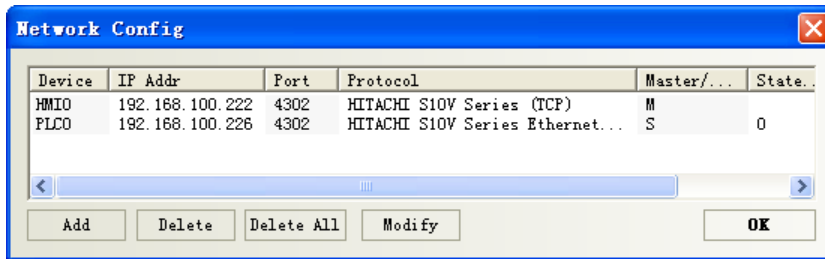
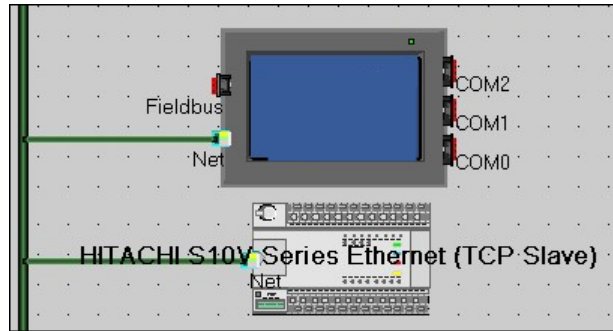

### HITACHI EHV Series Ethernet (TCP Slave) HMI Setting

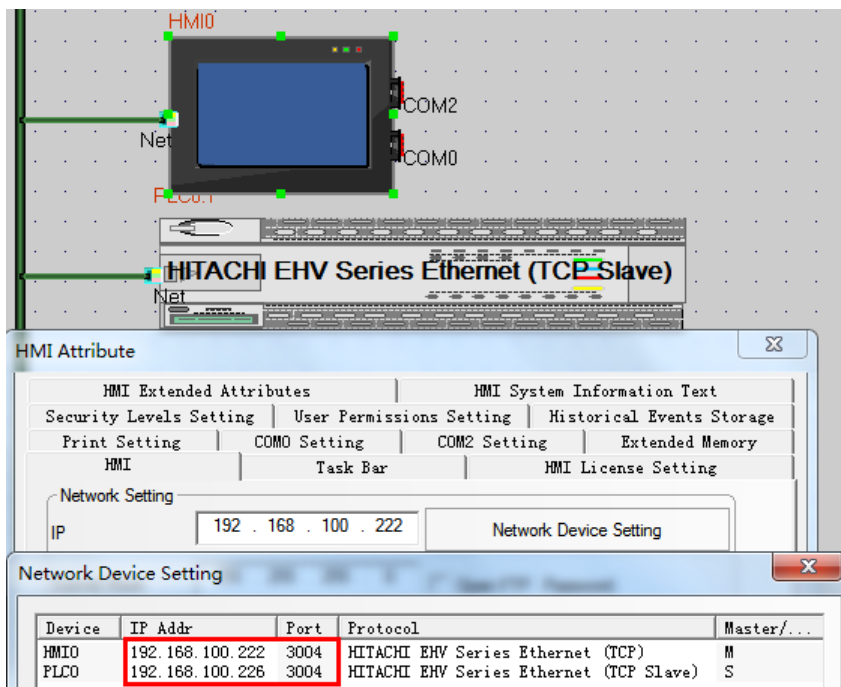

### © Supported Device

**Hitachi EH-A23DR**

Device	Bit Address	Word Address	Format	Notes
External Input	X 00.000-5A.095	-----	HHH.DDD	Read Only
External Output	Y 00.000-5A.095	-----	HHH.DDD	
Remote Input	X 100.000-9FF.095	-----	HHH.DDD	Read Only
Remote Output	Y 100.000-9FF.095	-----	HHH.DDD	
Internal Output	R 0000-FFFF	-----	HHHH	
Data Area	M 0000-FFFF	-----	HHHH	
First CPU Link	L 00000-03FFF	-----	HHHHH	
Second CPU Link	L 10000-FFFFF	-----	HHHHH	
On Delay Timer	TD 00000-65535	-----	DDDDD	
External Input	-----	WX 000.00-05A.09	HHH.DD	Read Only
External Output	-----	WY 000.00-05A.09	HHH.DD	
Remote Input	-----	WX 100.00-9FF.09	HHH.DD	Read Only
Remote Output	-----	WY 100.00-9FF.09	HHH.DD	
Word Internal Output	-----	WR 0000-C3FF	HHHH	
Special Word Output	-----	WRF 000-FFFF	HHHH	
Data Area	-----	WM 0000-FFFF	HHHH	
First CPU Link	-----	WL 0000-03FF	HHHH	
Second CPU Link	-----	WL 1000-FFFF	HHHH	
Timer Counter	-----	TC 00000-65535	DDDDD	

**Note:** X0.015 in the HMI match x15 in the PLC, Y1.000 in the HMI match Y100, WX0.09 in the HMI match WX9 in the Plicate effective address is deleted radix point and the first zero behind radix point.

**The list of address correspondence**

Bit Address	Word Address	PLC address	Notes
X 00.000-00.047	-----	X 0000-0047	
Y 01.000-01.031	-----	Y 0100-0131	
-----	WX 000.00-000.03	WX 0000-0003	
-----	WY 001.00-Y001.01	WY 0010-0011	

**Note:** The range of X, Y, WX, WY is according to the I/O assign. Make sure the I/O address before using the register.

**Note:****1. Communication setting**

EH series, only port1 supports procedure 2. Switch DIP and change special Internal Input (WR) value to select procedure.

EH150 series, only EHCPU\*\*\*A/448/516/548 support procedure 2.

EH PLC connect with PC only by procedure 1.

**2. CPU related actions****EH150**

DIP 5 must be set on.

If DIP 5 is on, which procedure (1 or 2) to use by judging the value of the **WR F037**. The highest bit of **WR F037** must be on, so that the other bits can be written in. The data keep on, when turn on the power again.

o By entering **0x8000**, turn on the power again and value of the address is **0x0000**. After settings, communication with procedure 1.

o By entering **0xC000**, turn on the power again and value of the address is **0x4000**. After settings, communication with procedure 2.

The transmission speed of port 1 will be set with DIP 3, 4 switches

o 3 on, 4 off is 19200 bps

The transmission speed of port 2 will be set with DIP 6, PHL switches.

o 6 off, PHL on is 19200 bps

#### MicroEH

The transmission speed will be set with DIP switches

o SW1 on is 19200 bps

Which procedure (1 or 2) to use by judging the value of the **WR F01A**. Different with EH150, The highest bit of **WR F01A** is optional, The data will reset when turn on the power again. If the value of **R 7F6** is set on, the data of **WR F01A** will be stored in Flash memory.

o **0x0000** for procedure 1.

o **0x8000** for procedure 2.

**Note:** if procedure 2 is set and written in Flash memory, external device (only supports procedure 1) or ladder editor will not connect with it.

#### **S10V**

Device	Bit Address	Word Address	Format	Notes
S	S 0-BFF	-----	HHH	
Z	Z 0-3FF	-----	HHH	
E	E 0-FFF	-----	HHH	
V	V 0-FFF	-----	HHH	
P	P 0-7F	-----	HH	
N	N 0-FF	-----	HH	
CCC	CCC 0-FF	-----	HH	
CR	CR 0-FF	-----	HH	
CD	CD 0-FF	-----	HH	
CU	CU 0-FF	-----	HH	
UUU	UUU 0-FF	-----	HH	
UU	UU 0-FF	-----	HH	
TTT	TTT 0-1FF	-----	HHH	
TT	TT 0-1FF	-----	HHH	
K	K 0-FFF	-----	HHH	
M	M 0-FFF	-----	HHH	
R	R 0-FFF	-----	HHH	

G	G 0-FFF	-----	HHH	
Q	Q 0-FFF	-----	HHH	
Y	Y 0-FFF	-----	HHH	
J	J 0-FFF	-----	HHH	
X	X 0-FFF	-----	HHH	
OW	-----	OW 0-FFF	HHH	
IW	-----	IW 0-FFF	HHH	
DW	-----	DW 0-FFF	HHH	
FW	-----	FW 0-BFF	HHH	
SW	-----	SW 0-BF	HH	
ZW	-----	ZW 0-3F	HH	
EW	-----	EW 0-FF	HH	
VW	-----	VW 0-FF	HH	
PW	-----	PW 0-8	H	
NW	-----	NW 0-F	H	
CW	-----	CW 0-F	H	
UW	-----	UW 0-F	H	
TW	-----	TW 0-1F	HH	
KW	-----	KW 0-FF	HH	
MW	-----	MW 0-FF	HH	
RW	-----	RW 0-FF	HH	
GW	-----	GW 0-FF	HH	
QW	-----	QW 0-FF	HH	
YW	-----	YW 0-FF	HH	
JW	-----	JW 0-FF	HH	
XW	-----	XW 0-FF	HH	
CC	-----	CC 0-FF	HH	
CS	-----	CS 0-FF	HH	
UC	-----	UC 0-FF	HH	
US	-----	US 0-FF	HH	
TC	-----	TC 1FF	HHH	
TS	-----	TS 0-1FF	HHH	

#### HITACHI EHV Series Ethernet (TCP Slave)

Device	Bit Address	Word Address	Format	Notes
Timer	T 0-65535	-----	DDDDD	
Internal output(shared Bit/Word)	M 0-FFFFF	-----	HHHHH	
Link area No.n(n is 0 to 7)	L 0-73FFF	-----	HHHHH	
Internal output	R 0-FFFF	-----	HHHH	
External output	Y 0-65535	-----	DDDDD	
External input	X 0-65535	-----	DDDDD	

Timer progress value	-----	TC 0-65535	DDDDD	
Internal output	-----	WM 0-FFFF	HHHH	
Link area No.n(n is 0 to 7)	-----	WL 0-FFFF	HHHH	
Internal output	-----	WR 0-FFFF	HHHH	
External output	-----	WY 0-65535	DDDDD	
External input	-----	WX 0-65535	DDDDD	

© Cable Diagram

Hitachi EH-A23DR RS232 communication cable

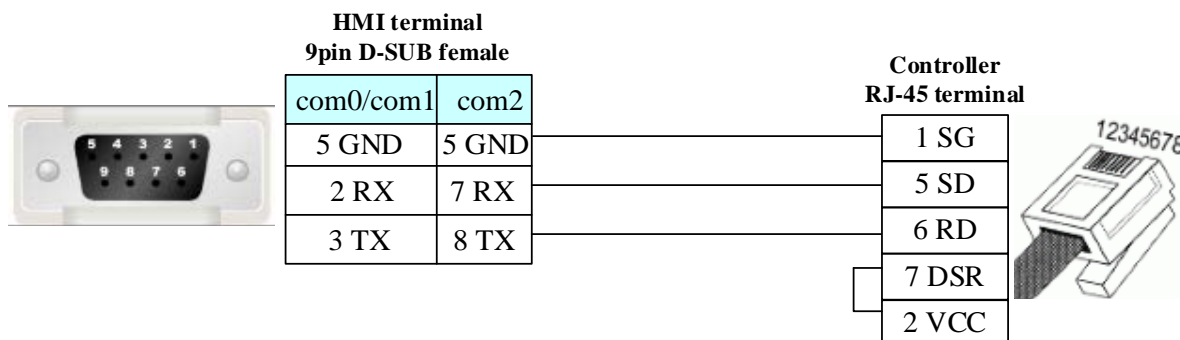

Hitachi EH-A23DR RS422 communication cable

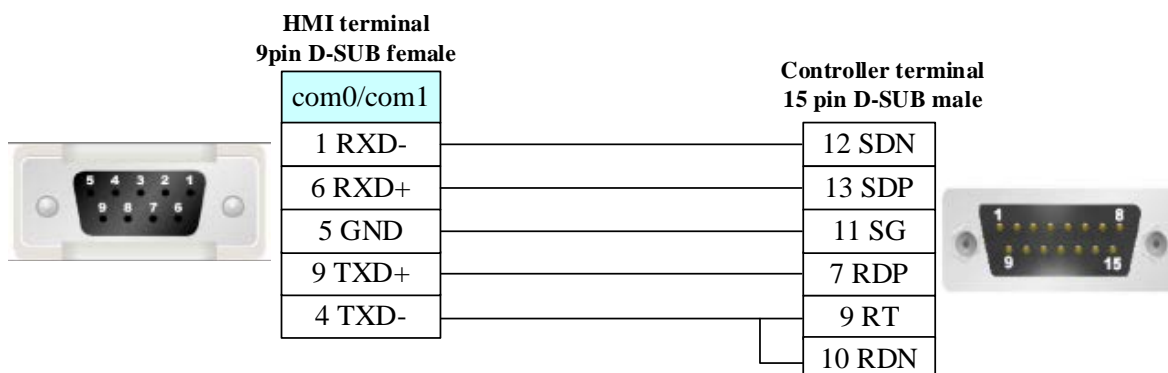

Ethernet Cable

Cross-connection or crossover network cable can be used as communication cable via the hub  
Refer to [4.3 Download by Network Ethernet](#) for method of making connection cable.

4.31 Hollysys Corporation

© Serial Communication

Series	CPU	Link Module	Driver
Hollysys LM	LM3109	Serial port0 on CPU 485 Serial port1 on CPU 232	Hollysys LM Modbus RTU



	LM3107	RS232 on CPU	
Hollysys LK		RS232 on CPU	Hollysys LK Modbus RTU

◎ Ethernet Communication

Series	CPU	Link Module	Driver
Hollysys LK	LK210	Ethernet interface on CPU	Hollysys LK Modbus TCP Slave*1

\*1 Support dual redundancy

◎ Serial System Configuration

Series	CPU	Link Module	COMM Type	Parameter	Cable
Hollysys LM	LM3109	RS232 on the CPU unit	RS232	<a href="#">Setting</a>	<a href="#">Your owner cable</a>
		RS485 on the CPU unit	RS485	<a href="#">Setting</a>	<a href="#">Your owner cable</a>
	LM3107	RS232 on the CPU unit	RS232	<a href="#">Setting</a>	<a href="#">Your owner cable</a>
Hollysys LK		RS232 on the CPU unit	RS232	<a href="#">Setting</a>	<a href="#">Your owner cable</a>

◎ Ethernet System Configuration

Series	CPU	Link Module	COMM Type	Parameter	Cable
Hollysys LK	LK210	ETH on the CPU unit	ETH	<a href="#">Setting</a>	<a href="#">Your owner cable</a>

◎ Serial Communication Setting

HMI Setting

Default communication parameters: 38400, 8, none, 1; station: 51

RS232

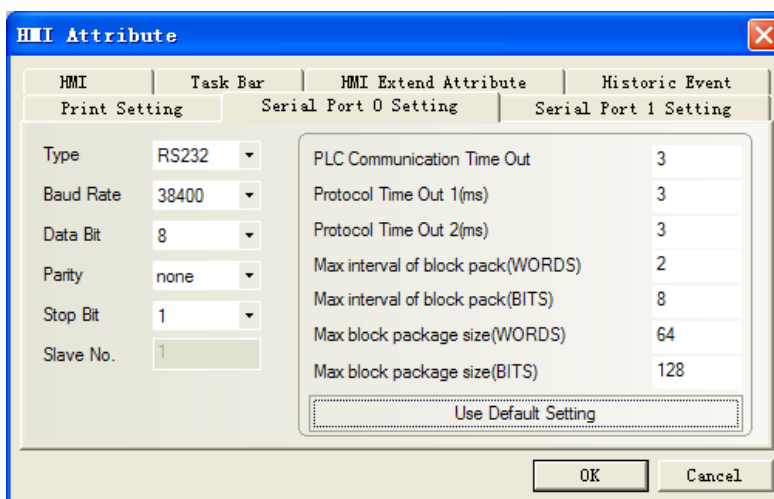

RS485

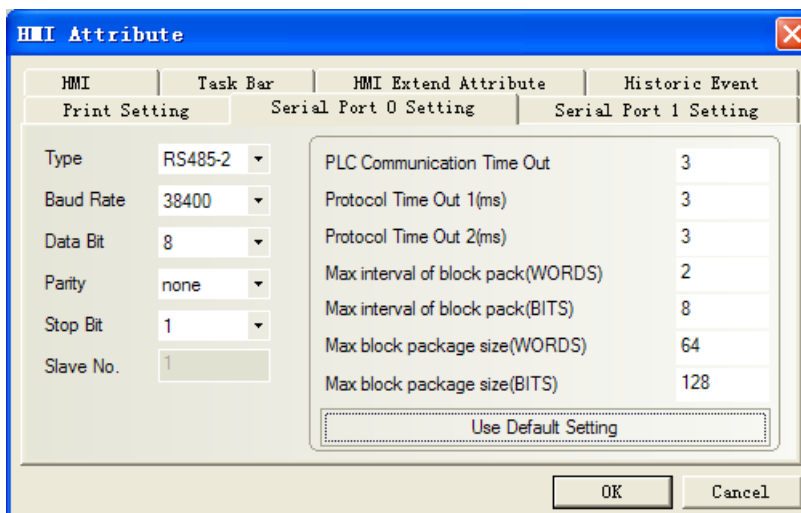

## ⊙ Ethernet Communication Setting

### HMI Setting

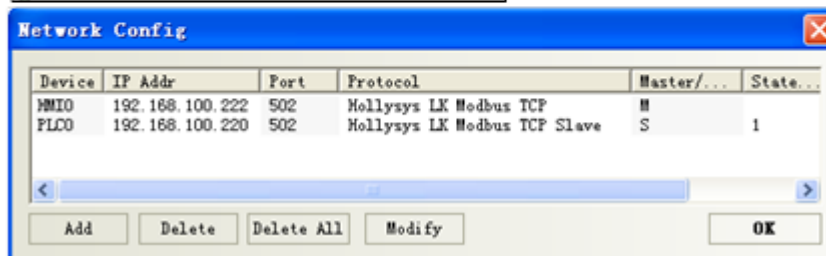
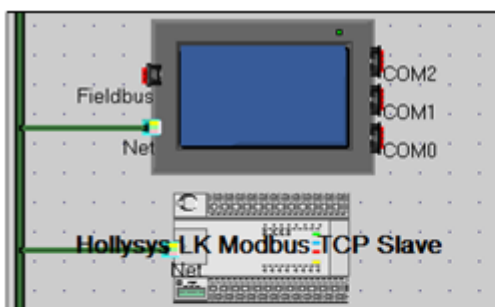

**Note:** In the dual redundancy system, just set one of IP addresses in Network Device Setting

### PLC Setting

Must set the PLC station in PLC program software.

## ⊙ Supported Device

### LM

Device	Bit Address	Word Address	Format	Notes
Discrete inputs and image Relay	I0.0-2.7	-----	D.O	
Discrete outputs and image Relay	Q0.0-1.7	-----	D.O	
Internal memory Relay	M100.0-7816.7	-----	DDDD.O	M0-99 are occupied by system diagnosis.
Analog inputs	-----	IW0	D	address must be an even number;
Analog outputs	-----	QW0	D	
Internal register	-----	MW0-8190	DDDD	IW,QW address

Internal register(double word)	-----	MD0-8188	DDDD	range to 30 by adding a module
--------------------------------	-------	----------	------	--------------------------------

**Note:** I,IW register read only

**LK**

Device	Bit Address	Word Address	Format	Notes
Outputs Relay	0X 1-65535	-----	DDDDD	
Inputs Relay	1X 1-65535	-----	DDDDD	
Analog inputs	-----	3X 1-65535	DDDDD	
Data Register	-----	4X 1-65335	DDDDD	
Data Register(DWord)	-----	5X 1-65535	DDDDD	

© **Cable Diagram**

**Hollysys LM RS232 communication cable**

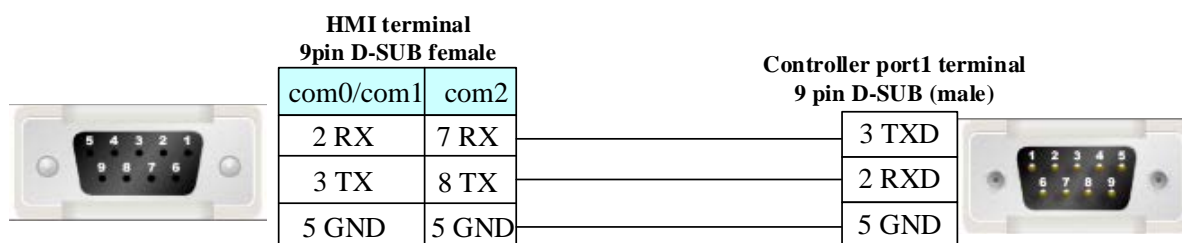

**Hollysys LM RS485 communication cable**

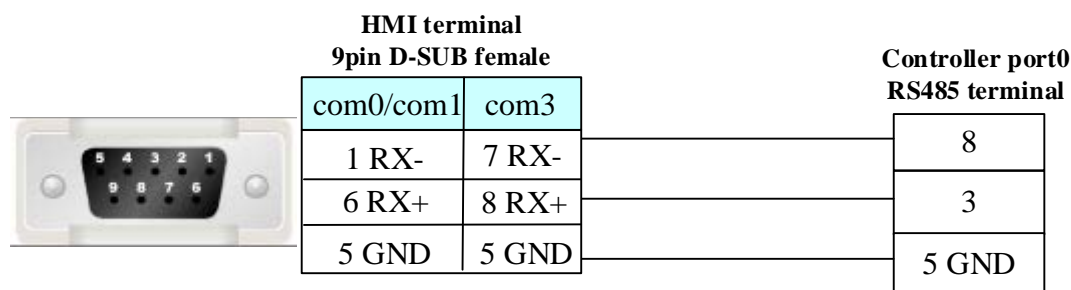

**Ethernet Cable**

Cross-connection or crossover network cable can be used as communication cable via the hub  
Refer to [3.3 Download by Network Ethernet](#) for method of making connection cable.

**4.32 HuaDA HD-JZ06**

© **Serial Communication**

Series	CPU	Link Module	Driver
HD	HD-JZ06	RS232 on the CPU unit	HuaDA HD-JZ06\ HuaDA
		RS485 on the CPU unit	HD SLAVE

◎ **System configuration**

Series	CPU	Link Module	COMM Type	Parameter	Cable
HD	HD-JZ06	RS232 on the CPU unit	RS232	<a href="#">Setting_</a>	<a href="#">Your owner cable</a>
		RS485 on the CPU unit	RS485	<a href="#">Setting_</a>	<a href="#">Your owner cable</a>

◎ **Communication Setting**

**RS232 communication**

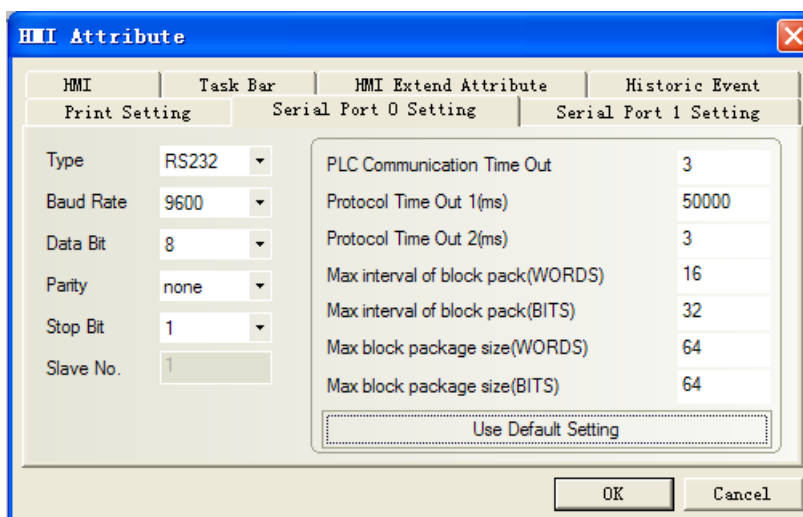

**RS485 communication**

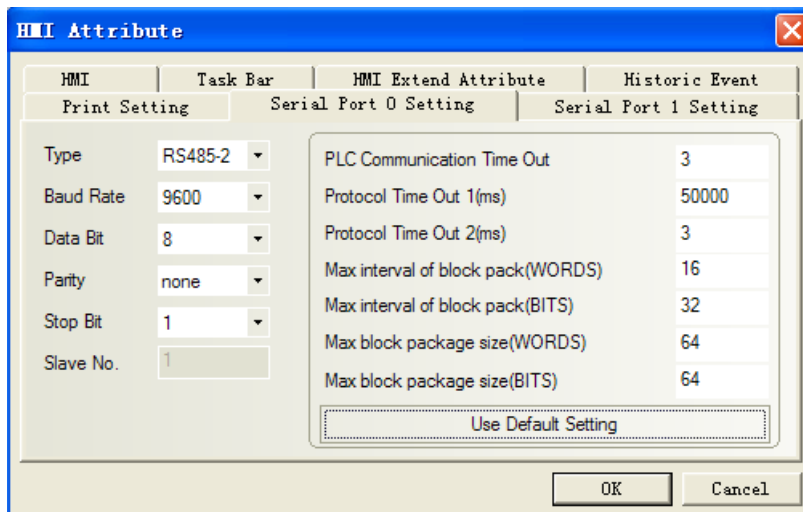

◎ **Supported Device**

Device	Bit Address	Word Address	Format	Notes
HMI Internal Relay	LB 0-4095	-----	DDDD	
MCU Register	VB 0-4095	-----	DDDD	
HMI Internal register	-----	LW 0-4094	DDDD	
MCU Register	-----	VW 0-4094	DDDD	

◎ **Cable Diagram**

### RS232 Port

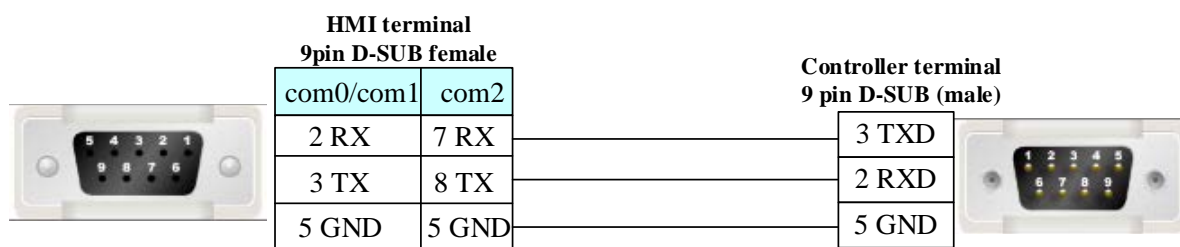

### RS485 Port

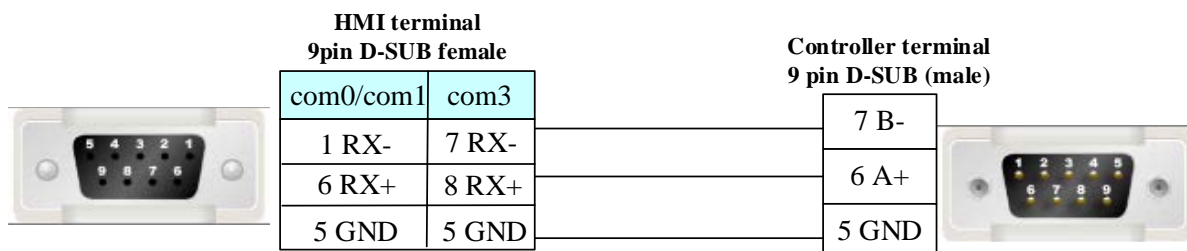

## 4.33 IDEC Corporation

### ◎ Serial Communication

Series	CPU	Link Module	Driver
MICRO SMART	FC4A-C10R2 FC5A-C24R2 FT1A-H48SA	RS232 on the CPU unit	IDEC MicroSmart

### ◎ Ethernet Communication

Series	CPU	Link Module	Driver
MicroSmart	FC6A	Ethernet on CPU	<b>IDEC MicroSmart FC6A Series (TCP Slave)</b>

### ◎ Serial System configuration

Series	CPU	Link Module	COMM Type	Parameter	Cable
MICRO SMART	FC4A-C10R2 FC5A-C24R2 FT1A-H48SA	RS232 on the CPU unit	RS232	<a href="#">Setting</a>	<a href="#">Your owner cable</a>
		RS485 on the CPU unit	RS485	<a href="#">Setting</a>	<a href="#">Your owner cable</a>

### ◎ Ethernet System Configuration

Series	CPU	Link Module	COMM Type	Parameter	Cable
MicroSmart	FC6A	Ethernet on CPU	ETH	<a href="#">Setting</a>	<a href="#">Your owner cable</a>

### ◎ Serial Communication Setting

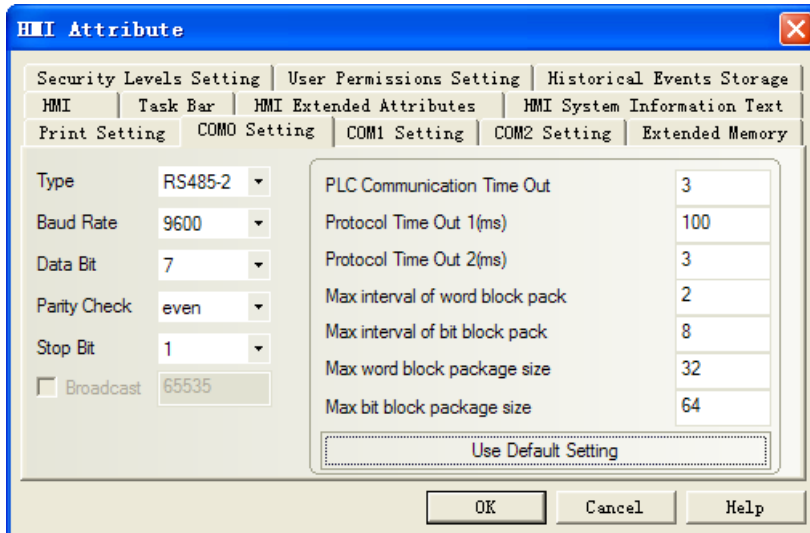
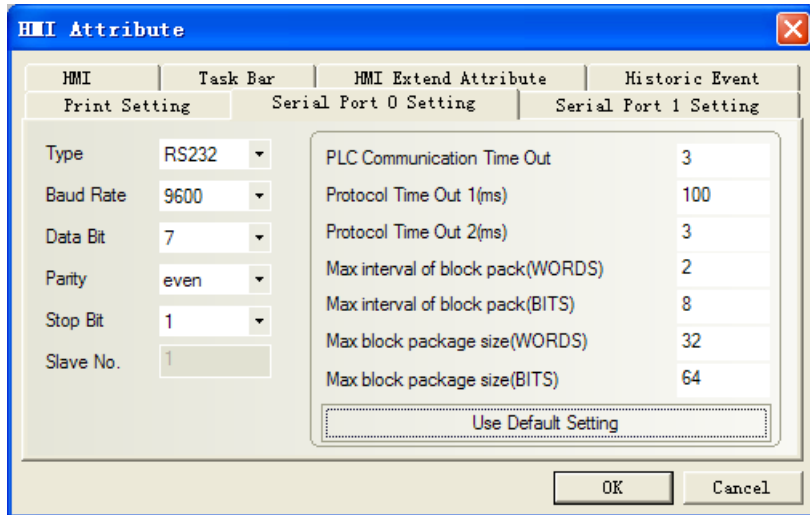

## © Ethernet Communication Setting

### HMI Setting

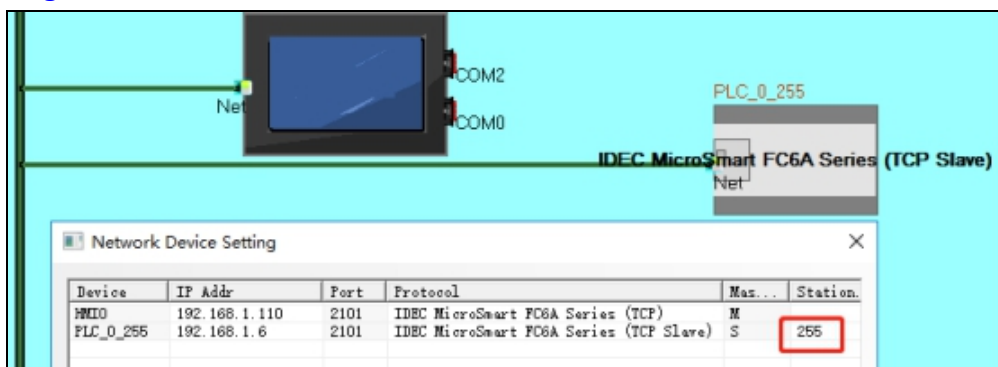

### PLC Setting

Must set the PLC station in PLC program software.

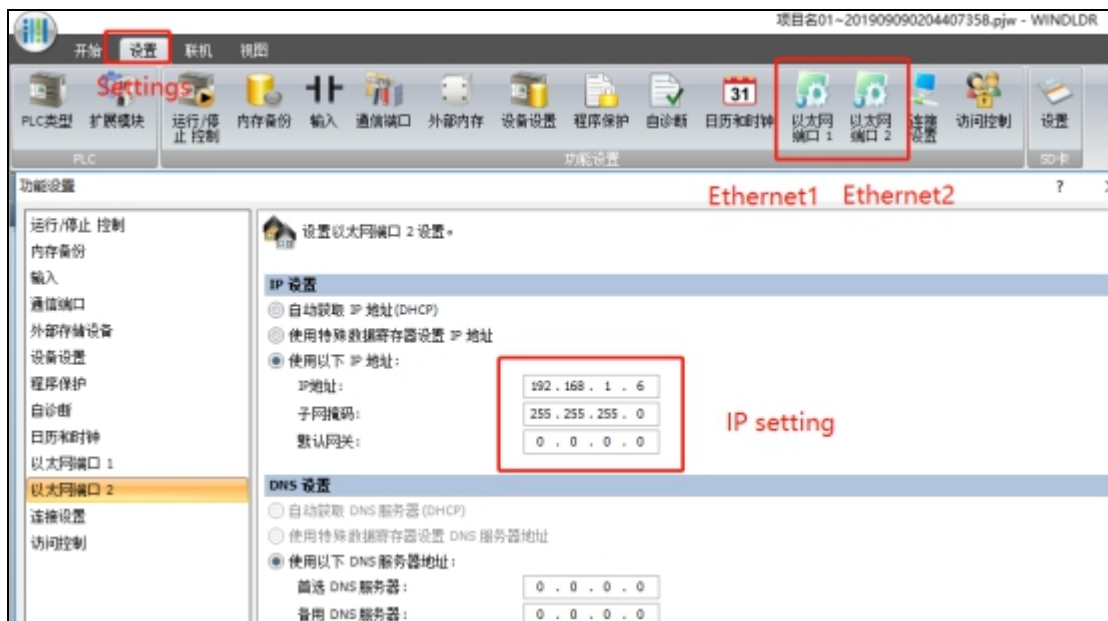

◎ Supported Device

IDEC MicroSmart

Device	Bit Address	Word Address	Format	Notes
Internal Relay	M0.0-127.7	-----	DDD.O	
Output	Q0.0-30.7	-----	DD.O	
Input	I0.0-30.7	-----	DD.O	
Data Register	-----	D 0-9999	DDDD	
Counter(Current Value)	-----	C_CV 0-999	DD	
Counter(Preset Value)	-----	C_SV 0-999	DD	
Timer(Current Value)	-----	T_CV 0-999	DD	
Timer( Preset Value)	-----	T_SV 0-999	DD	
Dword data register	-----	D_Dword0-9999	DDDD	

**Note:** M address: 121 in the plc correspond to 12.1 in the HMI.

Q\I address: 1277 in the plc corresponds to 127.7 in the HMI.

IDEC MicroSmart FC6A Series (TCP Slave)

Device	Bit Address	Word Address	Format	Notes
Internal Relay	M 0.0-1749.7	-----	DDDD.O	
Output	Q 0.0-63.7	-----	DD.O	
Input	I 0.0-63.7	-----	DD.O	
Counter	C 0-511	-----	DDD	
Timer	T 0-1023	-----	DDDD	
R Register	R 0-255	-----	DDD	
Data Register	D_Bit 0.00-55999.15	-----	DDDDD.DD	

Data Word Register	-----	D 0-55999	DDDDD	
Data Double Register	-----	D_Dword 0-55998	DDDDD	
Internal Relay	-----	MW0.0-1748.0	DDDD.O	
Internal Double Relay	-----	M_Dword0.0-1746.0	DDDD.O	
Input Word Register	-----	IW 0.0-62.0	DD.O	
Input Double Register	-----	I_Dword 0.0-60.0	DD.O	
Output Word Register	-----	QW 0.0-62.0	DD.O	
Output Double Register	-----	Q_Dword 0.0-60.0	DD.O	
Counter(Current Value)	-----	CC 0-511	DDD	
Counter(Preset Value)	-----	CP 0-511	DDD	
Timer(Current Value)	-----	TC0-1023	DDDD	
Timer( Preset Value)	-----	TP 0-1023	DDDD	
R Word Register	-----	RW 0-240	DDD	
R Double Register	-----	R_Dword 0-224	DDD	

© Cable Diagram

Idec RS232 communication cable

FC4A

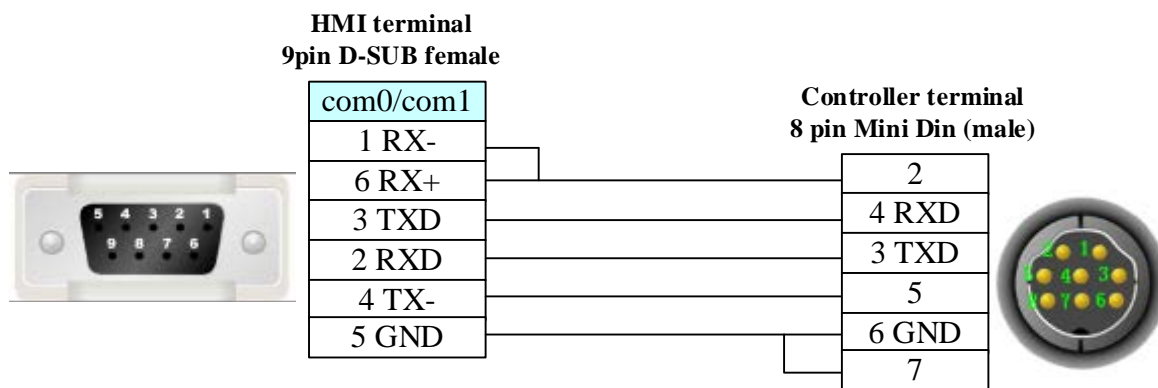

FC5A

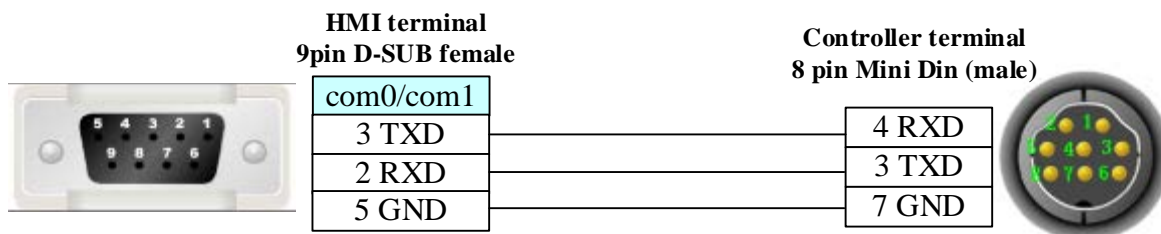

RS485



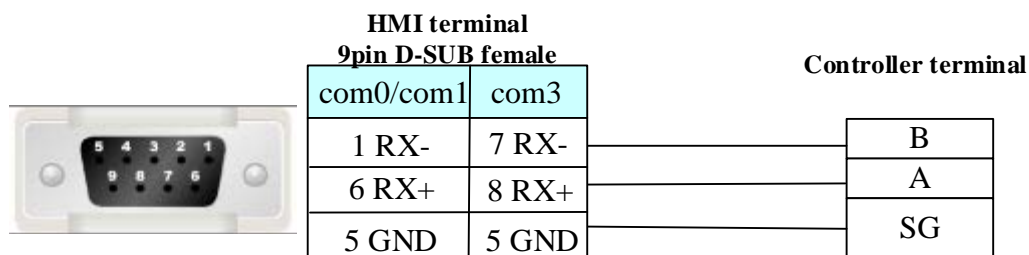

### Ethernet communication protocol cable

Cross-connection or crossover network cable can be used as communication cable via the hub

Refer to [3.3 Download by Network Ethernet](#) for method of making connection cable.

## 4.34 Inovance Electric Corporation

### ◎ Serial Communication

Series	CPU	Link Module	Driver
H2U	H2U-3624MR	CPU direct	Inovance H2u (don't support multi station)
		COM1	
		CPU direct	Modbus RTU*1
		COM1	
H3U	H3U-1616MT-XP	CPU direct	Inovance H3u (don't support multi station)
AM600	AM401-1608TP	RS485	Inovance AM600 Series

**NOTE:** \*1 Support multi-station

### ◎ Ethernet Communication

Series	CPU	Link Module	Driver
H3U	H3U-1616MT-XP	Ethernet interface on CPU	Inovance H3u Ethernet(TCP Slave)
AM600	AM401-1608TP	Ethernet interface on CPU	Inovance AM600 Ethernet(TCP Slave)

### ◎ Serial System configuration

Series	CPU	Driver	Link Module	COMM Type	Parameter	Cable
H2U	3624 MR	Inovance H2u	RS232 on the CPU unit	RS232	<a href="#">Setting</a>	<a href="#">Your owner cable</a>
			RS422 on the CPU unit	RS422	<a href="#">Setting</a>	<a href="#">Your owner cable</a>
			RS485 on the CPU unit	RS485	<a href="#">Setting</a>	<a href="#">Your owner cable</a>
			RS485 on the com1	RS485	<a href="#">Setting</a>	<a href="#">Your owner cable</a>
		Modbus RTU	RS485 on the CPU unit	RS485	<a href="#">Setting</a>	<a href="#">Your owner cable</a>
			RS485 on the com1	RS485	<a href="#">Setting</a>	<a href="#">Your owner cable</a>
H3U	1616MT-XP		RS232 on the CPU unit	RS232	<a href="#">Setting</a>	<a href="#">Your owner cable</a>
			RS422 on the CPU unit	RS422	<a href="#">Setting</a>	<a href="#">Your owner cable</a>
			RS485 on the com1	RS485	<a href="#">Setting</a>	<a href="#">Your owner cable</a>
AM600	AM401-1608TP		RS485 on the CPU unit	RS485	<a href="#">Setting</a>	<a href="#">Your owner cable</a>

◎ Ethernet System configuration

Series	CPU	Link Module	Connect Type	Parameter	Cable
AM600	H3U-1616MT-XP	Ethernet interface on CPU	Ethernet	<a href="#">Setting</a>	<a href="#">Your owner cable</a>
AM600	AM401-1608TP	Ethernet interface on CPU	Ethernet	<a href="#">Setting</a>	<a href="#">Your owner cable</a>

◎ Serial Communication Setting

Inovance H2u protocol

HMI Setting

HMI monitor protocol communication: 9600, 7, even, 1; station: 0

RS232

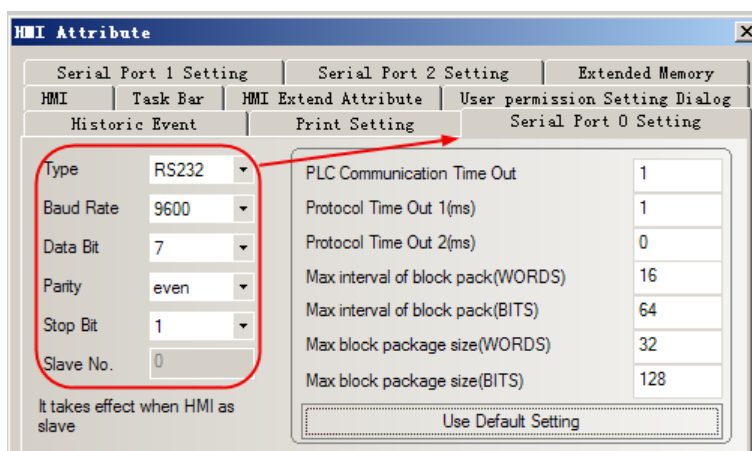

RS422

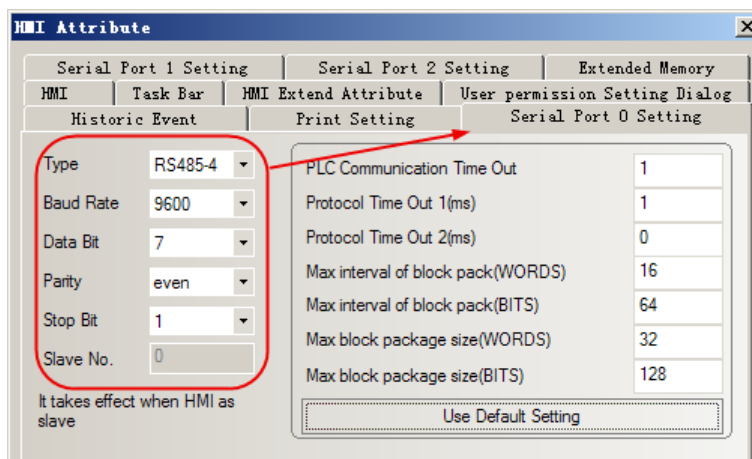

RS485

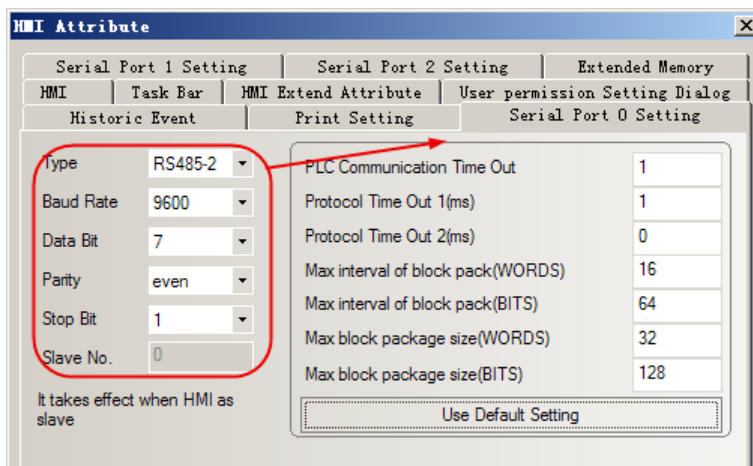

### PLC Setting

You should put off JPO, if communication on the COM0, RS485.

You should set D8126=01h, if communication on the COM1, RS485.

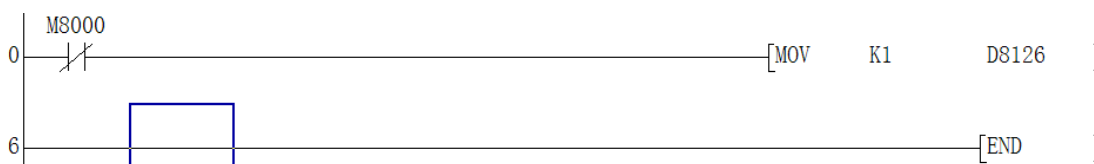

### Modbus RTU protocol

#### HMI Setting

**RS485 communication parameter:** PLC COM0 port is controlled by D8110; COM1 port is controlled by D8120.

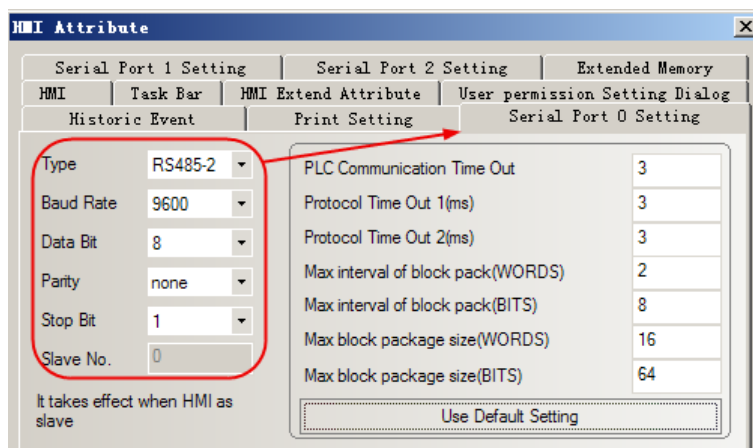

### PLC setting

COM0 setting: D8116=02h, modbus-RTU slave protocol; D8111=1, station: 1; D8110=81h, communication parameter: 9600, 8, none, 1.

COM1 setting: D8126=02h, modbus-RTU slave protocol; D8121=1, station: 1; D8120=81h, communication parameter: 9600, 8, none, 1.

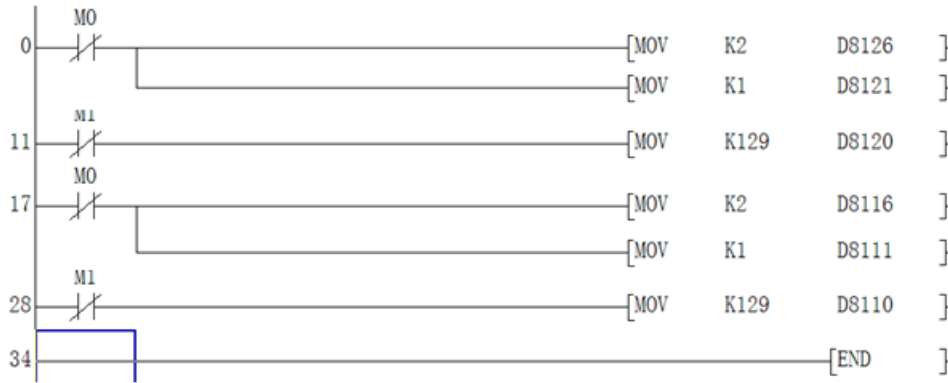

## Inovance H3u protocol

### HMI Setting

Default parameter: 9600bps, 7, even, 1; station NO.: 0

#### RS232

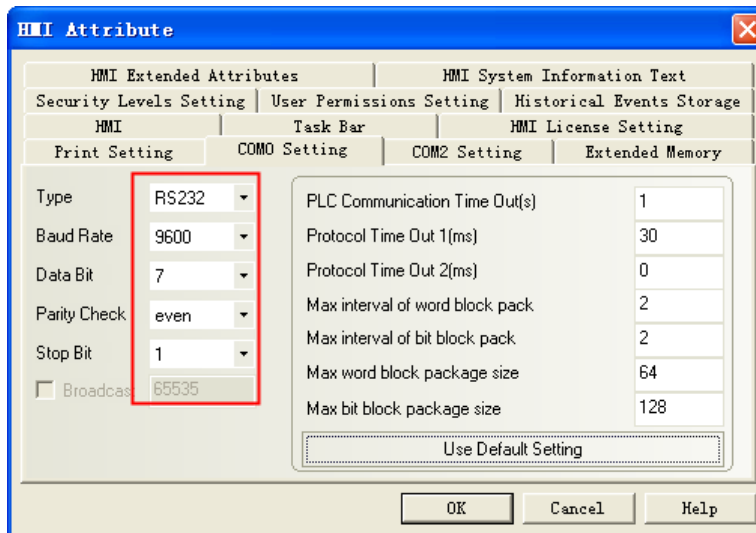

#### RS422

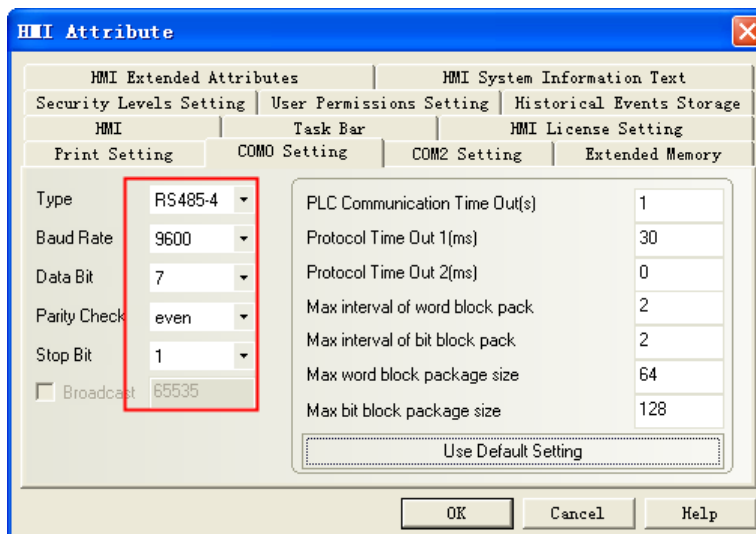

#### RS485

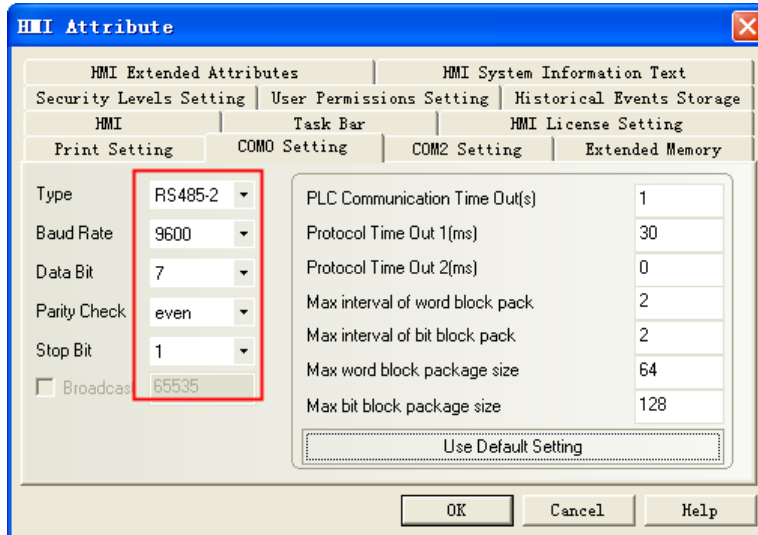

PLC Setting  
PLC COMO

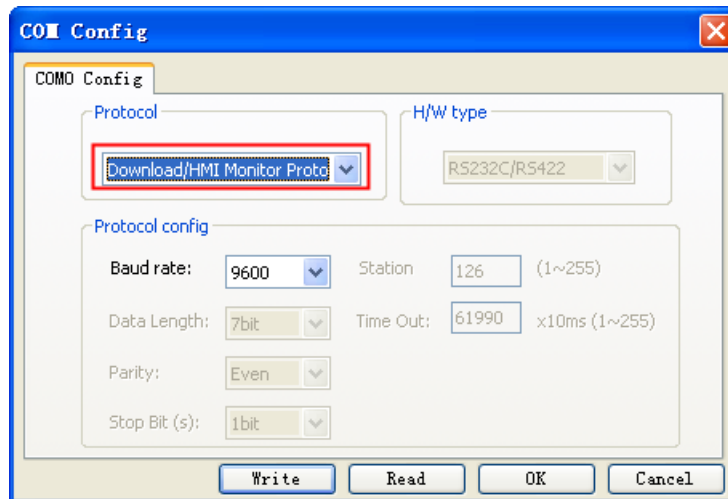

PLC COM1

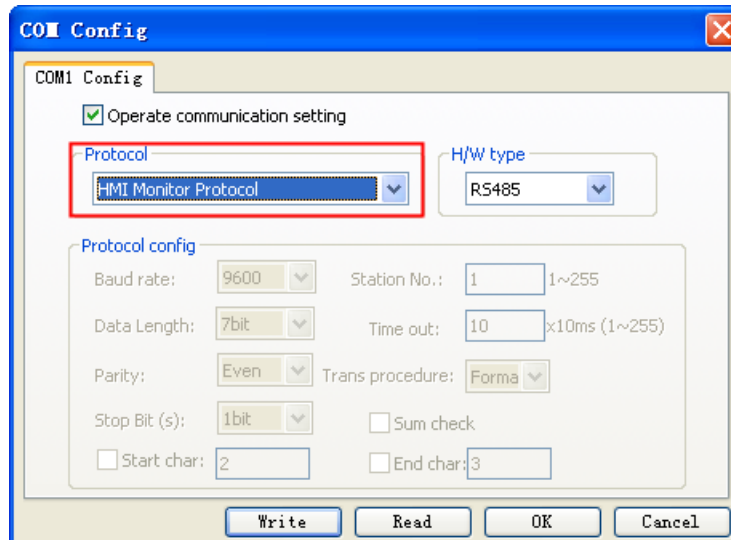

Note: COM1 parameter only support 9600bps;

Inovance AM600 Series protocol

## HMI Setting

Default parameter: 115200bps, 8, even, 1; station NO.: 1

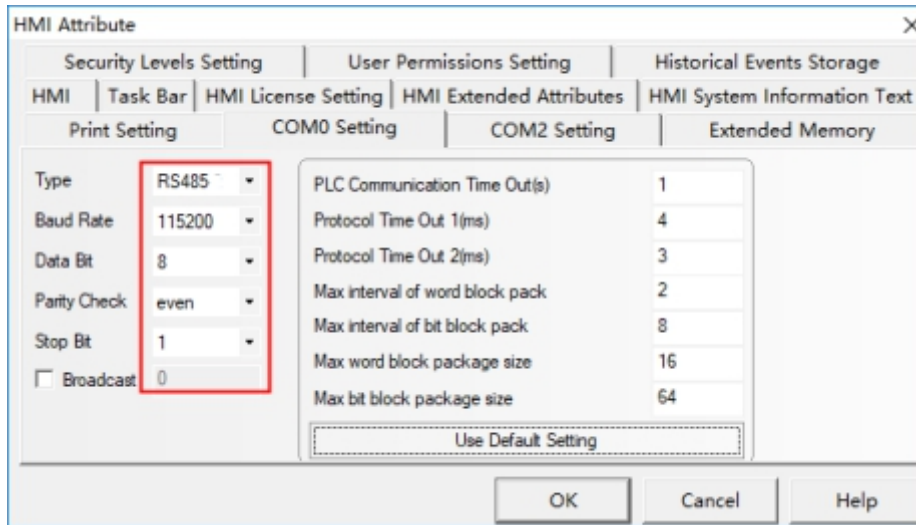

## PLC Setting

Connect PLC with PC by USB or network

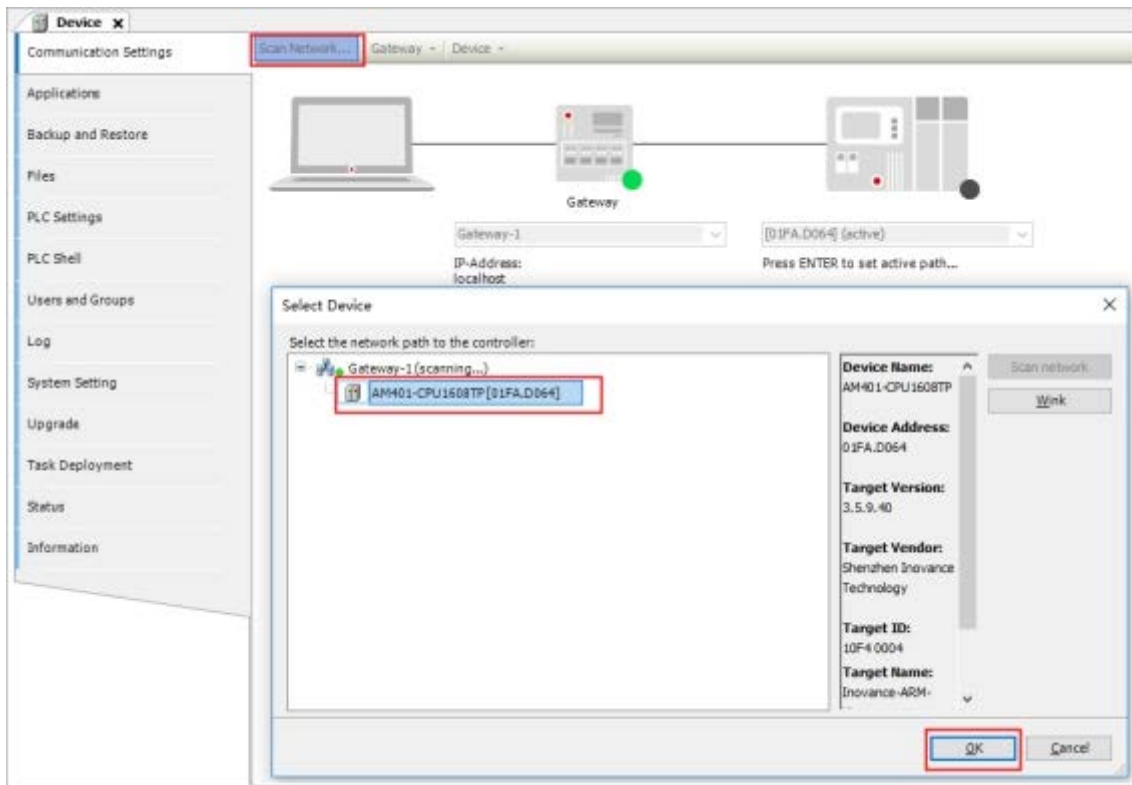

Defining the PLC variable

```

1  PROGRAM PLC_PRG
2  VAR
3
4      //QX
5      QX00 AT %QX0.0: BOOL;
6      QX01 AT %QX0.1: BOOL;
7      QX02 AT %QX0.2: BOOL;
8      QX03 AT %QX0.3: BOOL;
9      QX04 AT %QX0.4: BOOL;
10     QX05 AT %QX0.5: BOOL;
11     QX06 AT %QX0.6: BOOL;
12     QX07 AT %QX0.7: BOOL;
13
14     //IX
15     IX00 AT %IX0.0: BOOL;
16     IX01 AT %IX0.1: BOOL;
17     IX02 AT %IX0.2: BOOL;
18     IX03 AT %IX0.3: BOOL;
19     IX04 AT %IX0.4: BOOL;
20     IX05 AT %IX0.5: BOOL;
21     IX06 AT %IX0.6: BOOL;
22     IX07 AT %IX0.7: BOOL;

```

Online login PLC to monitor the value of the PLC variable

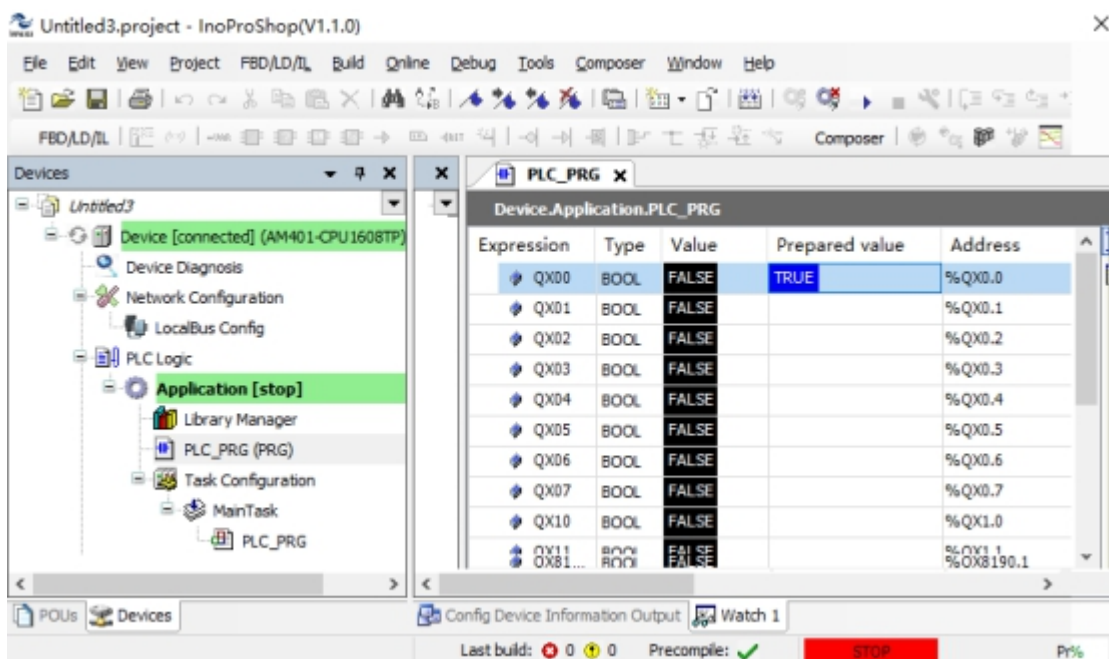
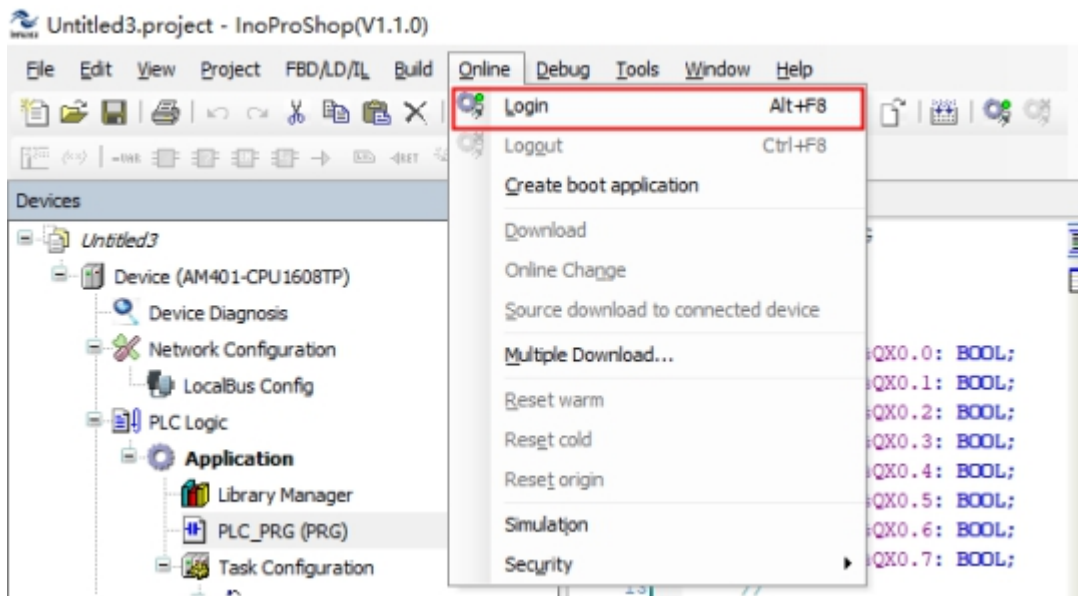

### © Ethernet Communication Setting

### Inovance H3u Ethernet (TCP Slave) protocol

#### HMI Setting

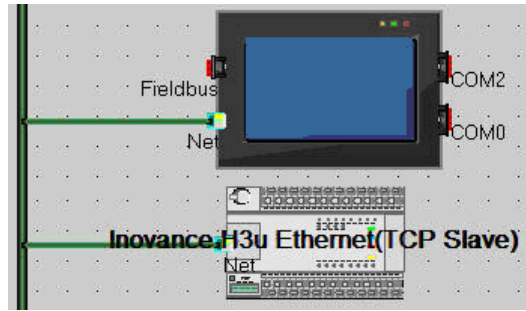

Device	IP Addr	Port	Protocol	Master/...	Stati...	Virtual...
HMI0	192.168.205.68	502	Inovanc...	M		
PLC0	192.168.205.112	502	Inovanc...	S	2	

#### PLC Setting

Set a right IP address.

### Inovance AM600 Ethernet (TCP Slave) protocol

#### HMI Setting

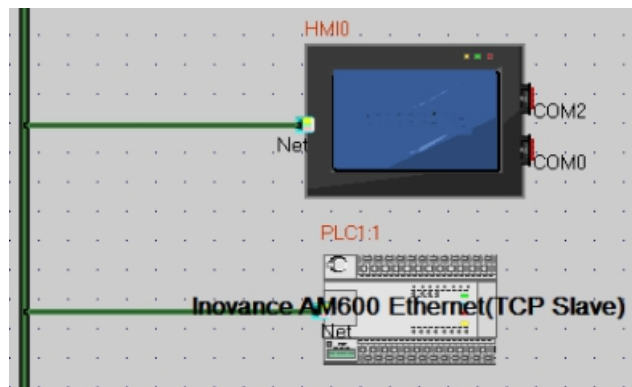

Device	IP Addr	Port	Protocol	Master/..
HMI0	192.168.205.48	502	Inovance AM600 Ethernet	M
PLC1	192.168.205.100	502	Inovance AM600 Ethernet(TCP Slave)	S

#### PLC Setting



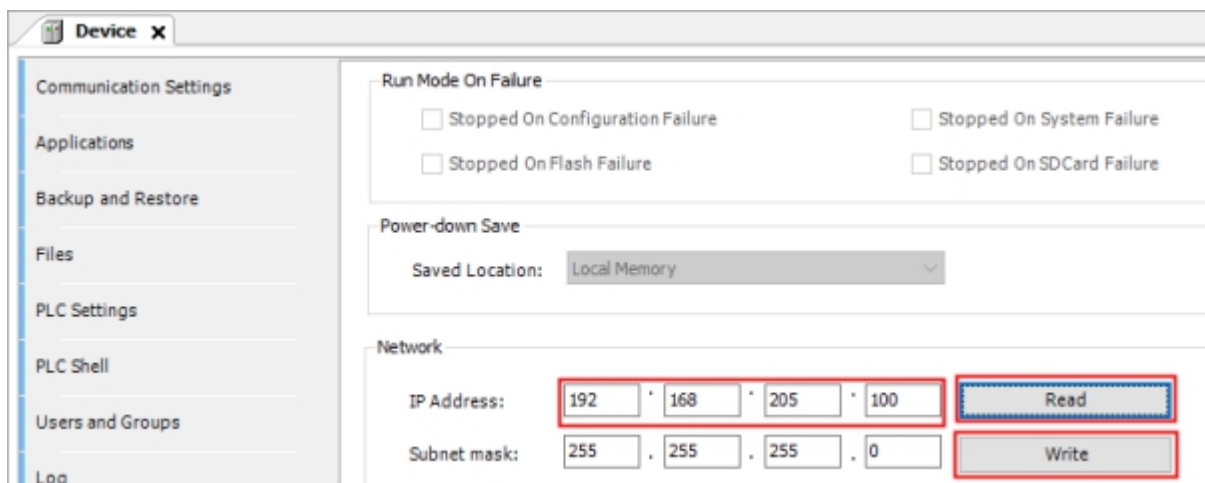

© Supported Device

Inovance H2u

Device	Bit Address	Word Address	Format	Notes
Input Relay	X 000-177	-----	OOO	
Output Relay	Y 000-177	-----	OOO	
Auxiliary Relay	M 0000-1535	-----	DDDD	
Timer Relay	T_bit 000-255	-----	DDD	
Counter Relay	C_bit 000-255	-----	DDD	
Data Register Relay	SM 8000-8255	-----	DDDD	
Status Relay	S 000-999	-----	DDD	
Timer	-----	T 000-255	DDD	
Counter	-----	C 000-255	DDD	
Data register	-----	D 0000-7999	DDDD	
Special Data Register	-----	SD 8000-8255	DDDD	
Counter Memory ( DWord )	-----	C_dword 200-255	DDD	

Inovance H3u Ethernet(TCP Slave)

Device	Bit Address	Word Address	Format	Notes
Input Relay	X0-377	-----	OOO	
Output Relay	Y0-377	-----	OOO	
Auxiliary Relay	M0-8511	-----	DDDD	
Data Register Relay	SM0-1023	-----	DDD	
Status Relay	S 0-4095	-----	DDDD	
Timer Relay	T 0-511		DDD	
Counter Relay	C 0-255		DDD	
Timer	-----	T0-511	DDD	
Counter	-----	C0-199	DDD	
Data register	-----	D0-8511	DDDD	

Special Data Register	-----	SD0-1023	DDDD	
R Register	-----	R 0-32767	DDDDD	

**Inovance H3u**

Device	Bit Address	Word Address	Format	Notes
Input Relay	X 0-377	-----	OOO	
Output Relay	Y 0-377	-----	OOO	
Auxiliary Relay	M 0-8511	-----	DDDD	
Data Register Relay	SM 0-1023	-----	DDDD	
Status Relay	S 0-4095	-----	DDDD	
Timer Relay	T_bit 0-511		DDD	
Counter Relay	C_bit 0-255		DDD	
Timer	-----	T 0-511	DDD	
Counter	-----	C 0-199	DDD	
Data register		C_dword 200-255	DDD	
Special Data Register	-----	D 0-8511	DDDD	
R Register	-----	SD 0-1023	DDDD	
Input Relay	-----	R 0-32767	DDDDD	

**AM600 series/Ethernet**

Device	Bit Address	Word Address	Format	Notes
Input Relay	IX 0.0-8191.7	-----	DDDD.D	
Output Relay	QX 0.0-8191.7	-----	DDDD.D	
Auxiliary register	-----	MW 0-65535	DDDDD	
Input register	-----	IW 0-4095	DDDD	
Output register	-----	QW 0-4095	DDDD	

**© Cable Diagram**

**COM0 port communication cable**

**RS232**

Please uses the programming cable: SC-09

**RS422**

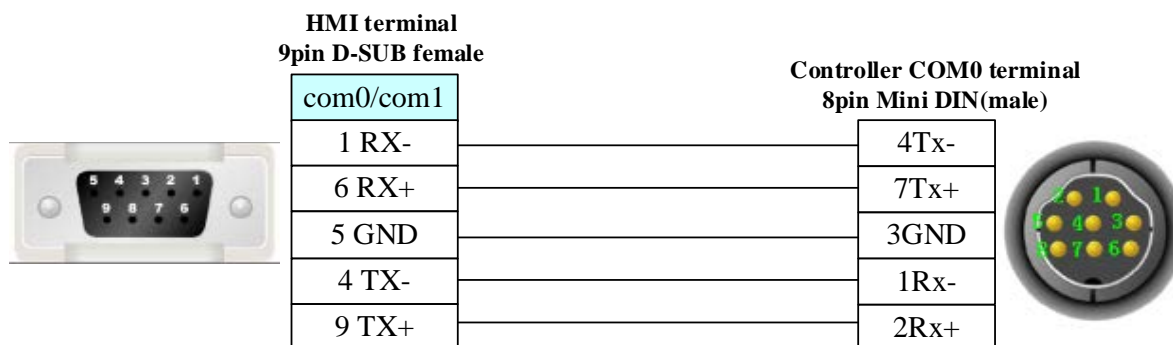

**RS485**

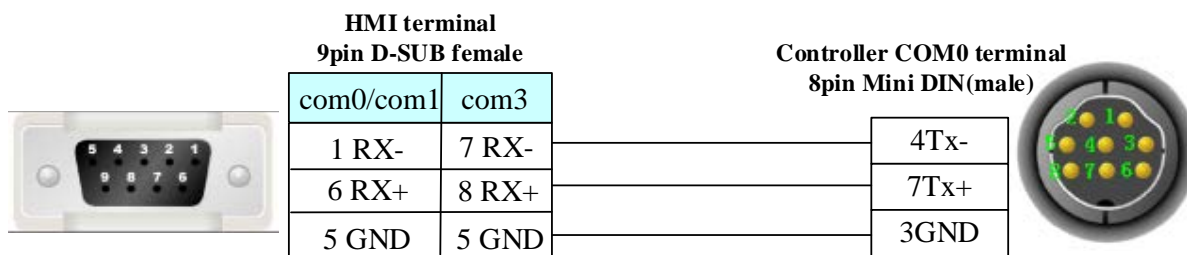

**NOTE:** Put off JP0 by RS485.

### COM1 port communication cable

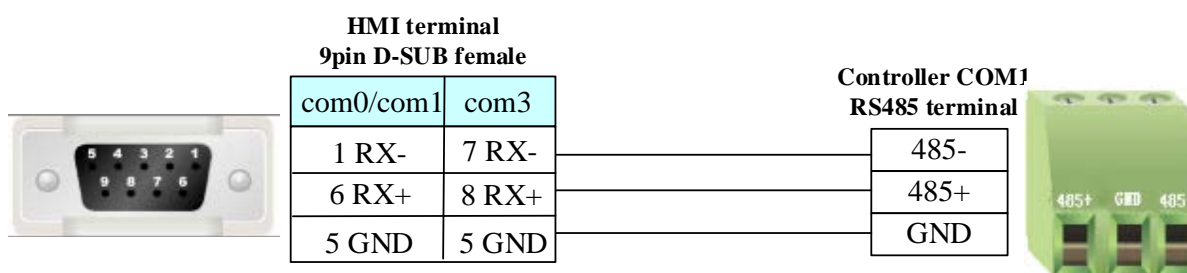

### AM600 Series cable

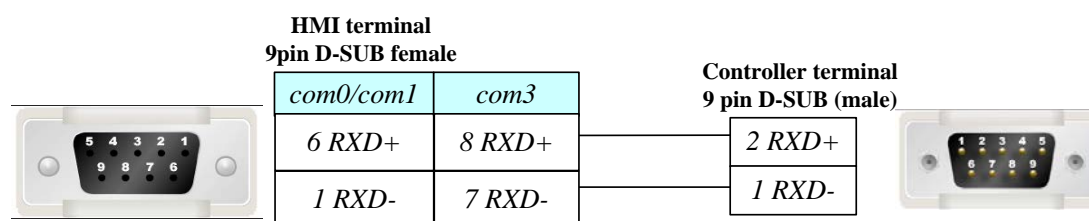

### Ethernet communication protocol cable

Cross-connection or crossover network cable can be used as communication cable via the hub  
Refer to [3.3 Download by Network Ethernet](#) for method of making connection cable.

## 4.35 Invt

### Serial Communication

Series	CPU	Link Module	Driver
INVT	IVC1	RS232 on the CPU unit	Invt IVC1

### System configuration

Series	CPU	Link Module	COM Type	Parameter	Cable
INVT	IVC1	RS232 on the CPU unit	RS232	<a href="#">Setting</a>	<a href="#">Your owner cable</a>
			RS485	<a href="#">Setting</a>	<a href="#">Your owner cable</a>

## ◎ Communication Setting

### HMI Setting

RS232 default communication: 9600, 8, none, 1; station number: 1

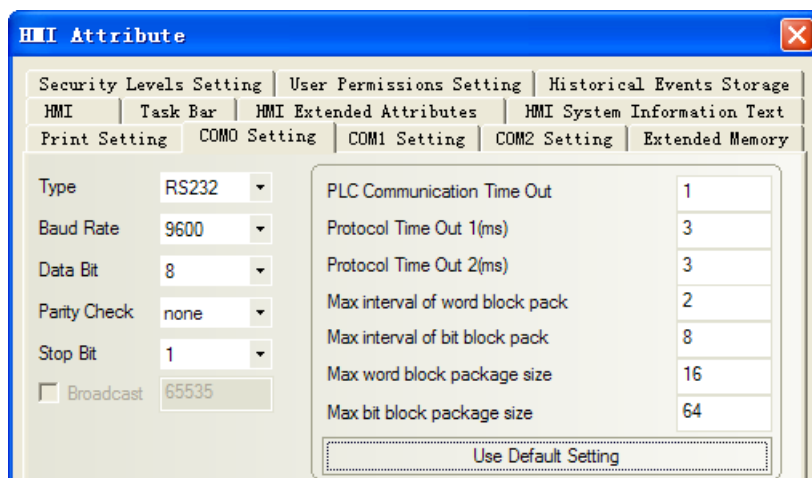

RS485 default communication: 9600, 8, none, 1; station number: 1

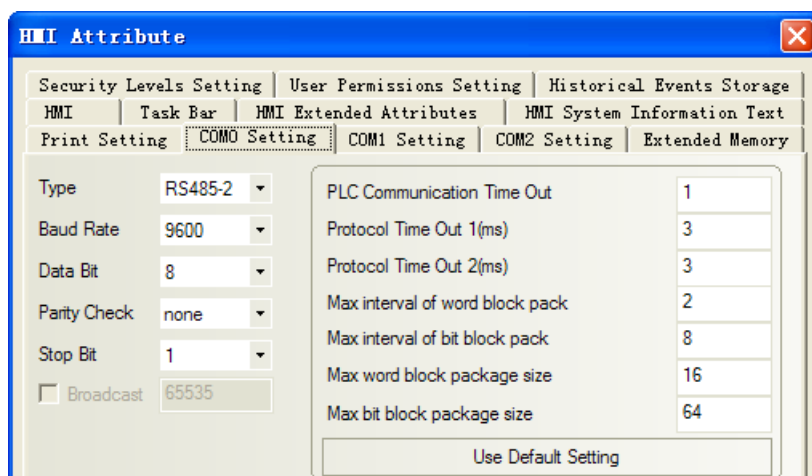

### PLC Setting

1. The PLC has two ports: port0 and port1, port1 support RS232 and RS485
2. Port0 configuration as follow:

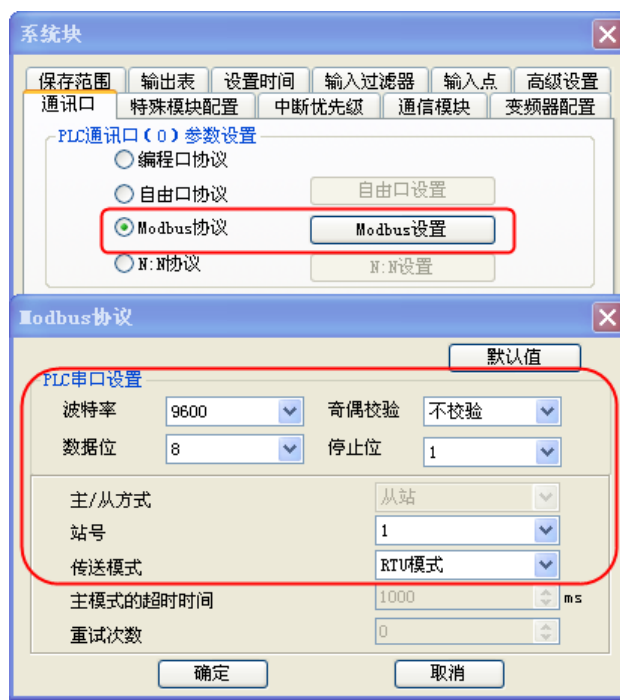

Port1 configuration as follow:

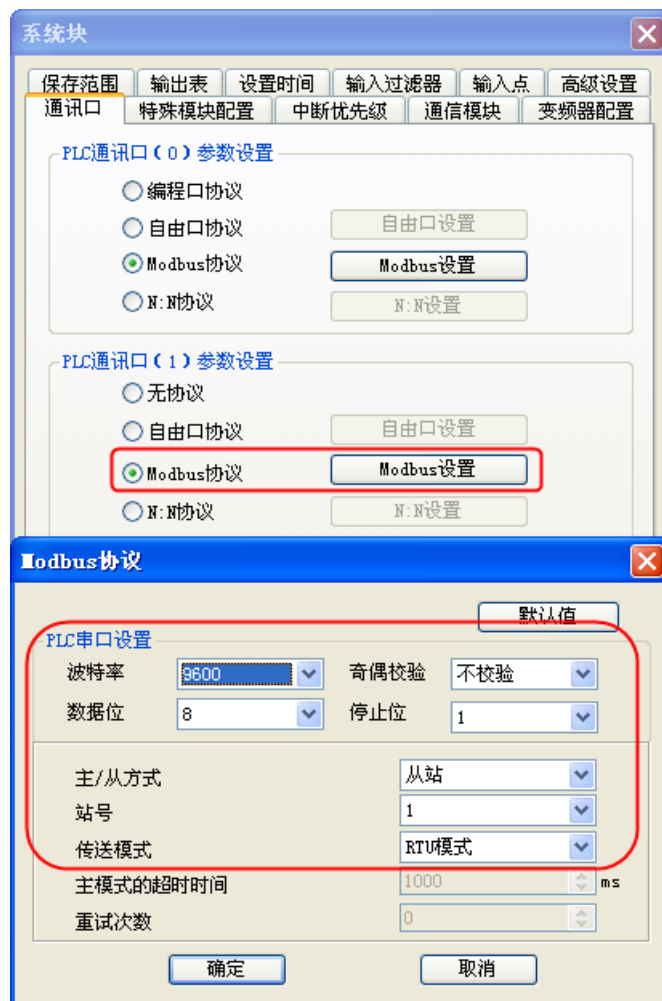

© Supported Device

Device	Bit Address	Word Address	Format	Notes
C_bit	C_bit 0-255	-----	DDD	
T_bit	T_bit 0- 255	-----	DDD	
S	S 0-1023	-----	DDDD	
SM	SM 0-255	-----	DDD	
M	M 0-2047	-----	DDDD	
Y	Y 0-177	-----	OOO	
X	X 0-177	-----	OOO	
SD_double	-----	SD_double 0-127	DDD	
D_double	-----	D_double 0-7999	DDD	
C_double	-----	C_double 200-255	DDD	
C_word	-----	C_word 0-199	DDD	
T_word	-----	T_word 0-255	DDD	
Z	-----	Z 0-15	DD	
SD	-----	SD 0-255	DDD	
D	-----	D 0-7999	DDDD	

### ◎ Cable Diagram

#### RS232 communication cable

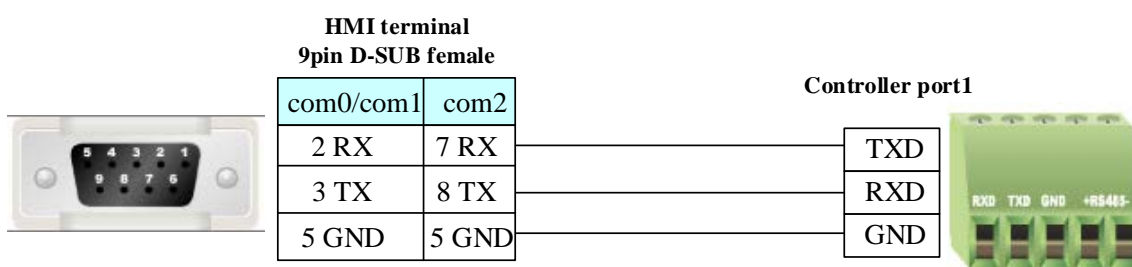
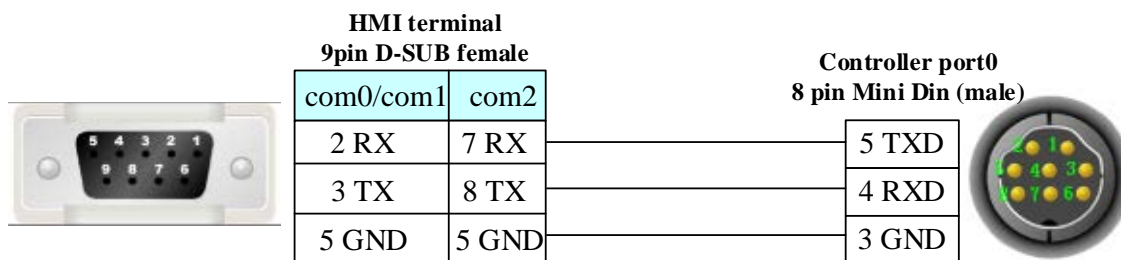

#### RS485 communication cable

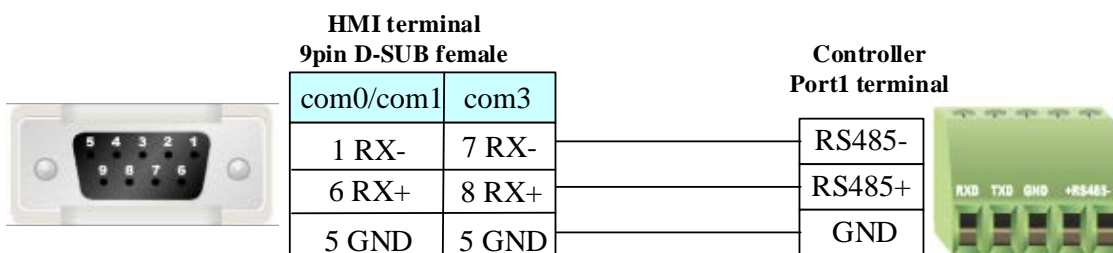

### 4.36 KDN Corporation

#### ◎Serial Communication

Series	CPU	Link Module	Driver
KDN-K3	KDN-K304-14AR	RS232 on the CPU unit	KDN-K3

#### ◎System configuration

Series	CPU	Link Module	COMM Type	Parameter	Cable
KDN-K3	K304-14AR	RS232 on the CPU unit	RS232	<a href="#">Setting</a>	<a href="#">Your owner cable</a>

#### ◎Communication Setting

##### KDN-K3 RS232 communication

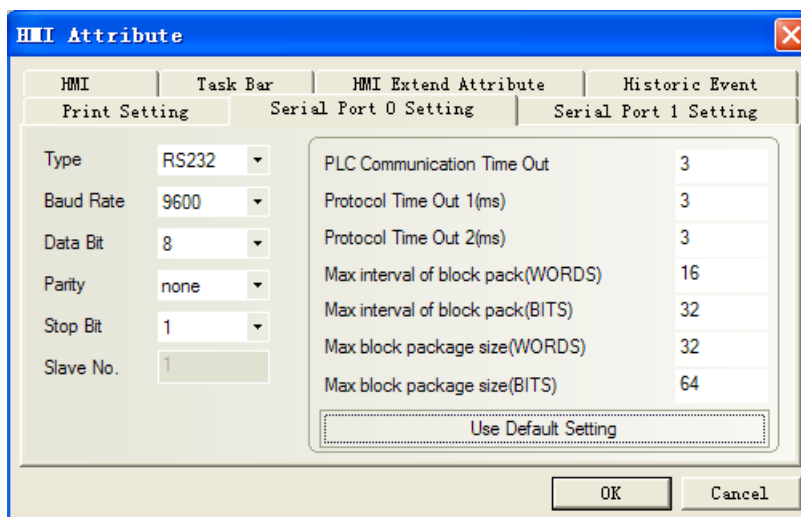

#### ◎Supported Device

##### KDN-K3

Device	Bit Address	Word Address	Format	Notes
Discrete inputs and image Relay	I0.0-7.7	-----	D.O	
Discrete outputs and image Relay	Q0.0-7.7	-----	D.O	
Internal memory Relay	M0.0-31.7	-----	DD.O	
Analog inputs	-----	AIW0-30	DD	
Analog outputs	-----	AQW0-30	DD	
Internal register	-----	VW0-4094	DDDD	
Internal register(double word)	-----	VD0-4092	DDDD	

#### NOTE:

- 1) AIW, AQW, VW, VD address must be an even number.
- 2) AIW and I device read only.
- 3) The single floating VR of PLC corresponds with the VD of the Ev5000 (choose single floating).

## ◎ Cable Diagram

### RS232 communication cable

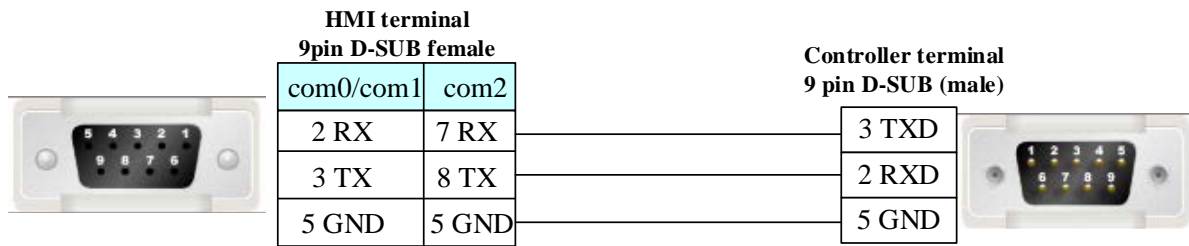

## 4.37 Kinco Corporation

### ◎ Serial Communication

Series	CPU	Link Module	Driver
Kinco	K2 Series	RS485 on the CPU port	Kinco PLC Series
	K3 Series	RS232 on the CPU unit	
		RS485 on the CPU port	
	K5 Series	RS232 on the CPU unit	
RS485 on the CPU port			

### ◎ System configuration

Series	CPU	Link Module	COMM Type	Parameter	Cable
Kinco	K2 Series	RS485 on the port	RS485	<a href="#">Setting</a>	<a href="#">Your owner cable</a>
	K3 Series	RS232 on the CPU unit	RS232	<a href="#">Setting</a>	<a href="#">Your owner cable</a>
		RS485 on the port	RS485	<a href="#">Setting</a>	<a href="#">Your owner cable</a>
	K5 Series	RS232 on the CPU unit	RS232	<a href="#">Setting</a>	<a href="#">Your owner cable</a>
RS485 on the port		RS485	<a href="#">Setting</a>	<a href="#">Your owner cable</a>	

### ◎ Communication Setting

#### RS232 communication



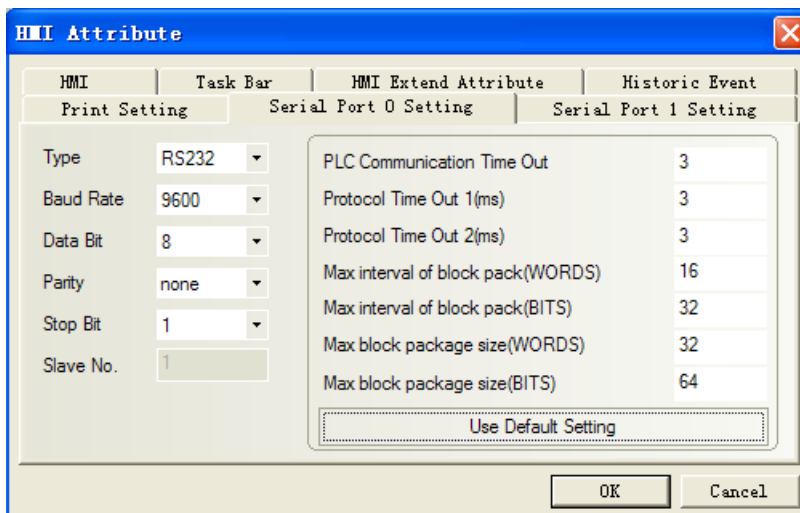

**RS485 communication**

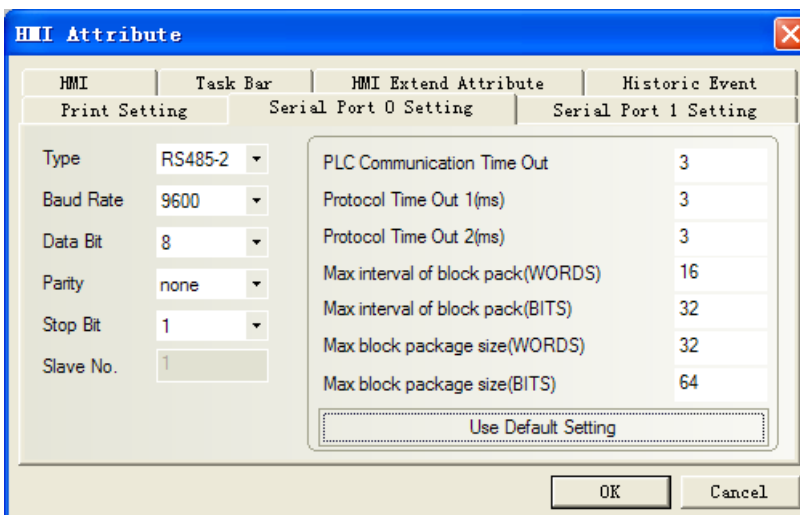

**© Supported Device**

Device	Bit Address	Word Address	Format	Notes
Discrete inputs and image Relay	I0.0-124.7	-----	D.O	
Discrete outputs and image Relay	Q0.0-124.7	-----	D.O	
Internal memory Relay	M0.0-4095.7	-----	DD.O	
Internal register	VW.B0.0-16383.7	-----	DDDD.O	
Analog inputs	-----	AIW0-62	DD	
Analog outputs	-----	AQW0-62	DD	
Internal register	-----	VW0-4094	DDDD	
Internal register(double word)	-----	VD0-4092	DDDD	
ERR	-----	ERR 0~127 <sup>*1</sup> ERR 128~255 <sup>*2</sup> ERR 256~383 <sup>*3</sup> ERR 384~511 <sup>*4</sup>	DDDD	

**NOTE:**

- 1) AIW, AQW, VW, VD address must be an even number.
  - 2) AIW and I device read only.
  - 3) The single floating VR of PLC corresponds with the VD of the Ev5000 (choose single floating).
- \*1 ERR0~127 indicate the recent 128 common errors. ERR0 is the latest error, ERR1 is the later error, and so on.
- \*2 ERR128~255 indicate the recent 128 serious errors. ERR128 is the latest error, ERR129 is the later error, and so on.
- \*3 ERR256~383 indicate the last 128 common errors the last time PLC is powered on. ERR256 is the last error, ERR257 is the previous error, and so on.
- \*4 ERR384~511 indicate the last 128 serious errors the last time PLC is powered on. ERR 384 is the last error, ERR385 is the previous error, and so on.

### ◎ Cable Diagram

#### RS232 communication cable

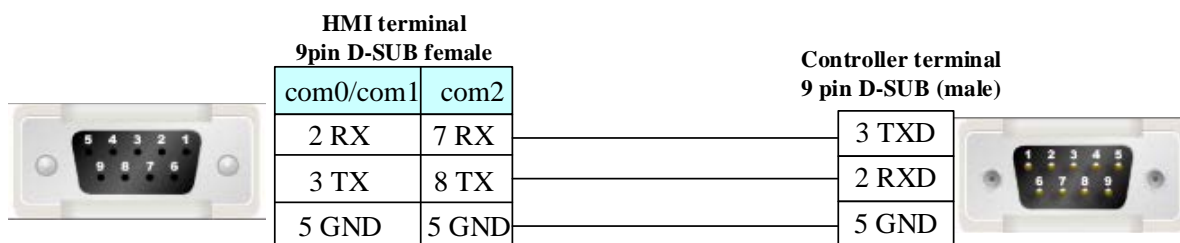

#### CPU304/CPU304EX/CPU306

##### RS485 communication cable

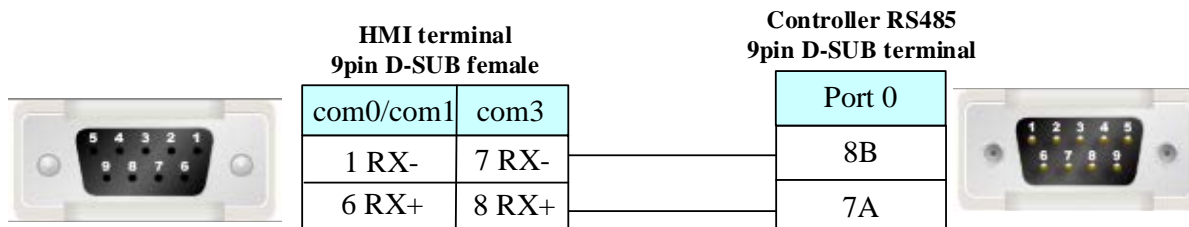

#### CPU306EX /308/504

##### RS485 communication cable

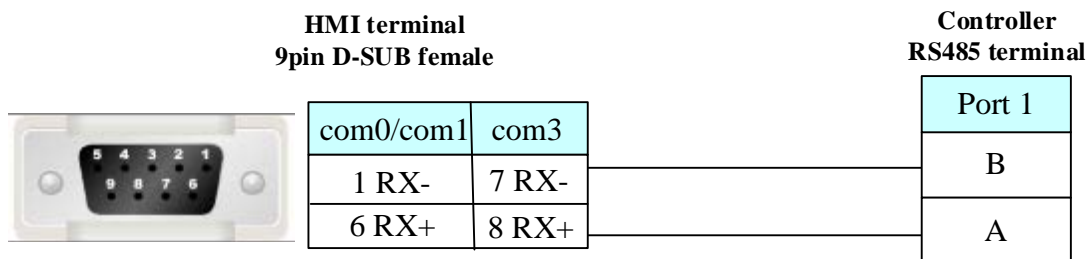

#### CPU506EA

##### RS485 communication cable

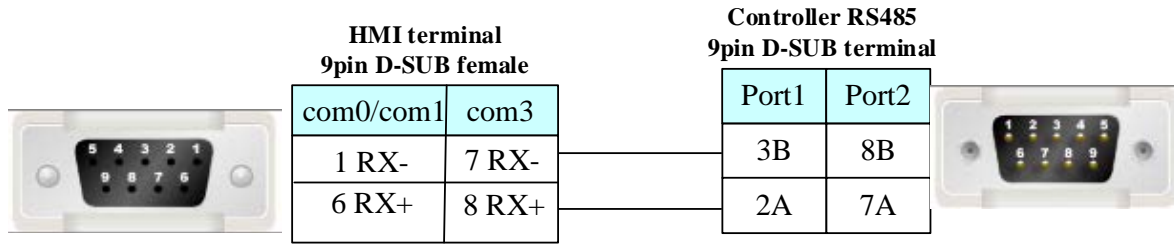

### 4.38 Kinco Inverter

#### ◎Serial Communication

Series	CPU	Link Module	Driver
FV100	FV100-2S-00156	RS485 on the CPU unit	<a href="#">Kinco Inverter</a>

#### ◎ Serial Communication Parameters and Cables Production

Series	CPU	Link Module	COMM Type	Parameter	Cable
FV100	FV100-2S-00156	RS485 on the CPU unit	RS485	<a href="#">Setting</a>	<a href="#">Your owner cable</a>

#### ◎Serial Communication Parameters

##### HMI Setting

Default communication: 9600bps, 8, even, 1; station: 5

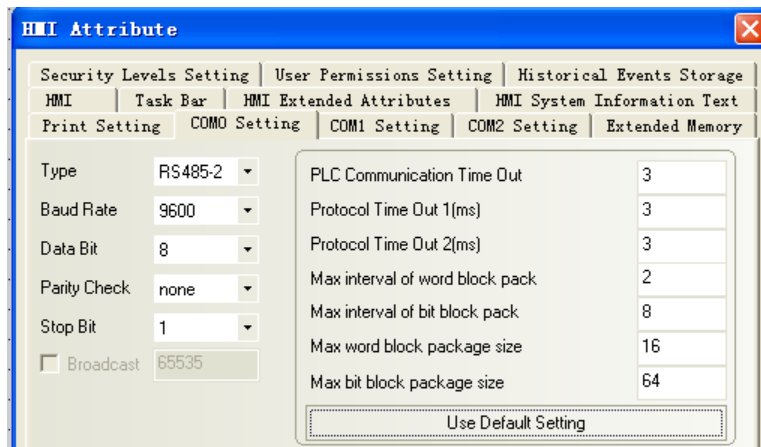

##### PLC Setting

###### A. Inverter operation panel menu

Key	Name	Function
MENU	Programming / Exit key	Enter or exit the programming status
ENTER	Function / Data key	Enter the submenu or confirm data
∧	Increase key	Incremental data or function code
∨	Decrease key	Decreasing the data or function code
SHIFT	Shift key	In edit mode, you can choose to modify the bit setting

		data; in other states, you can switch the display status parameters
M	Multifunction key	The key functions are set by b4.01
RUN	Run key	In the operation panel mode, press this key to run
STOP/RST	Stop / Reset key	Shutdown or fault reset

## B. Inverter function code parameters

### b3: Communication parameters

Function Code	Name	Range	Minimum unit	Factory setting	Change	machine setting range
b3.00	Communication Configuration	LED ones: Baud Rate Selection 0: 4800BPS 1: 9600BPS 2: 19200BPS 3: 38400BPS 4: 115200BPS 5: 125000BPS  LED tens: Data Format 0: 1-8-2-N, RTU 1: 1-8-1-E, RTU 2: 1-8-1-O, RTU 3: 1-7-2-N, ASCII 4: 1-7-1-E, ASCII 5: 1-7-1-O, ASCII  LED hundreds: Connection mode 0: Direct Cable Connection (232/485) 1: MODEM(232)	1	001	X	0~155H
b3.01	Machine Address	0~127, 0: Broadcast address	1	5	X	0~127

X: Operation can not be changed

C. Function code parameters of the inverter, control parameters and status parameters are mapped to Modbus read and write registers; inverter control parameters and status parameters are virtual inverter function code group; Function code group and its high byte register address map correspondence shown in the following table

Inverter parameter group	Mapped address high byte	Inverter parameter group	Mapped address high byte
A0	0x00	B2	0x0C
A1	0x01	B3	0x0D
A2	0x02	B4	0x0E
A3	0x03	C0	0x14
A4	0x04	C1	0x15
A5	0x05	D0	0x1E
A6	0x06	D1	0x1F
A7	0x07	D2	0x20

A8	0x08	U0	0x5A
B0	0x0A	Control parameters group	0x32
B1	0x0B	Status parameter group	0x33

Note: With function code parameter A3.02 example, the register address A3.02 to 0x0302, converted to decimal number 770, so the HMI set the address to  $770 + 1 = 771$  (decimal)

## ◎Supported Device

Device	Bit Address	Word Address	Format
Internal system / external output node	0X 1-65535	-----	DDDDD
Internal system / external input node	1X 1-65535	-----	DDDDD
Analog input data node	3X_bit 0.01-65535.15	-----	DDDDD.DD
Data Node	4X_bit 0.01-65535.15	-----	DDDDD.DD
4X single write data node	6X_bit 0.01-65535.15	-----	DDDDD.DD
Analog Input Data Register	-----	3X 1-65535	DDDDD
Data register	-----	4X 1-65535	DDDDD
Data register	-----	5X 1-65535	DDDDD
4X single write register	-----	6X 1-65535	DDDDD
Data register	-----	41X 1-65535	DDDDD
Data register	-----	43X-DINV 1-65535	DDDDD
Data register	-----	4X-DINV 1-65535	DDDDD
Data register	-----	3X-DINV 1-65535	DDDDD

Notes: 1.5X :Anti-byte; 4X-DINV, 3X-DINV: word high and low bit-reversed;

2.41X:Rewrite a single 16-length inverter function code parameter or control parameters, parameter values after the drive is powered down to save;

3.43X-DINV:Rewrite multiple inverter function code parameter or control parameters, parameter values after the drive is powered down to save;

## ◎Cables Production

### RS485 communication cable

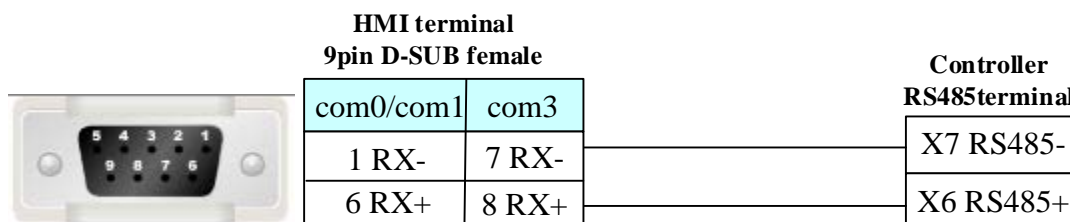

## 4.39 Kinco EB-MOD2P-01(Kinco Bus Bridge)

### ◎Serial Communication

Series	CPU	Link Module	Driver
FieldBus Bridge	EB-MOD2P-01	RS232 on the CPU unit	Kinco EB-MOD2P-01 Modbus RTU
		RS485 on the CPU unit	
		RS422 on the CPU unit	

© System configuration

Series	CPU	Link Module	COMM Type	Parameter	Cable
FieldBus Bridge	EB-MOD2P-01	RS232 on the CPU unit	RS232	<a href="#">Setting</a>	<a href="#">Your owner cable</a>
		RS422 on the CPU unit	RS422	<a href="#">Setting</a>	<a href="#">Your owner cable</a>
		RS485 on the CPU unit	RS485	<a href="#">Setting</a>	<a href="#">Your owner cable</a>

© Communication Setting

EB-MOD2P-01 RS232 communication

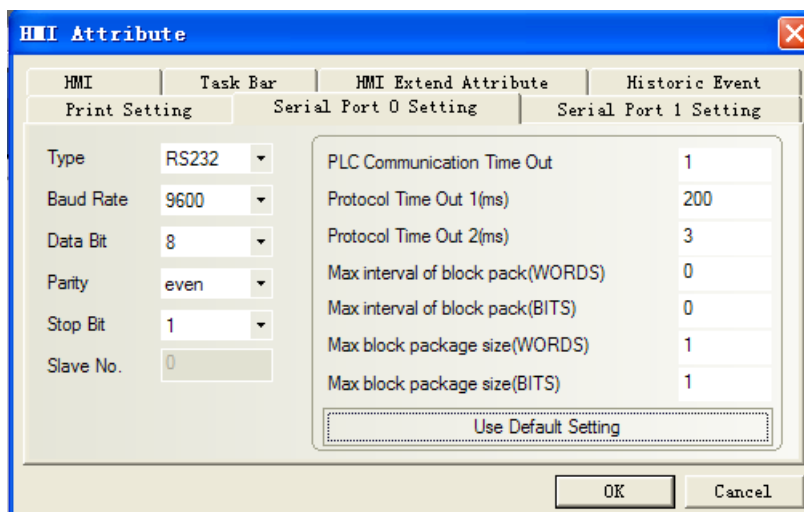

NOTE: Communication parameter must be the same as the controller panel.

EB-MOD2P-01 RS422 communication

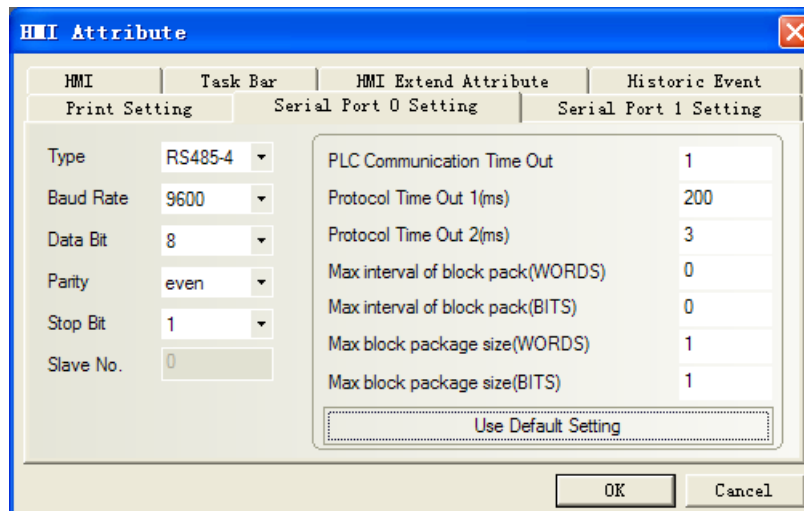

EB-MOD2P-01 RS485 communication

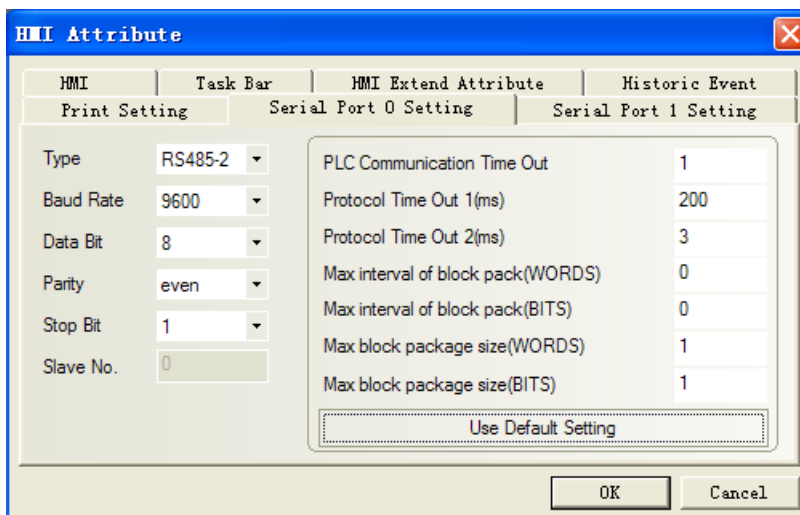

### © Supported Device

#### EB-MOD2P-01

Device	Bit Address	Word Address	Format	Notes
Internal/External Output bit	0X1-60	-----	DDDDD	
Internal/External Input bit	1X1-60	-----	DDDDD	
Data Register bit	3X_bit1-60	-----	DDDDD	
Data Register bit	4X_bit1-60	-----	DDDDD	
Simulate Input Register bit	-----	3X1-60	DDDDD	
Data Register	-----	4X1-60	DDDDD	
Data Register	-----	5X1-60	DDDDD	
Data Register	-----	6X1-60	DDDDD	
Data Register	-----	3X-DINV 1-60	DDDDD	
Data Register	-----	4X-DINV 1-60	DDDDD	

**NOTE:** The correspondence between the device of EV5000 and the s7-300 software, as follows:

4X-DINV-----PID  
 e.g.: 4X-DINV1-----PID256      4X-DINV3-----PID260

3X-DINV-----PQD  
 e.g.: 3X-DINV1-----PQD256      3X-DINV3-----PQD260

4X-----PIW  
 e.g.: 4X1-----PIW256      4X2-----PIW258

3X-----PQW  
 e.g.: 3X1-----PQW256      3X2-----PQW258

0X-----I  
 e.g.: 0X1-----I0.0      0X9-----I1.0

1X-----Q  
 e.g.: 1X1-----Q0.0      1X9-----Q1.0

4X\_BIT-----PIW (binary)  
 e.g.: 4X\_BIT1.0~~1.15-----PIW256 (binary)

3X\_BIT-----PQW (binary)

e.g. : 3X\_BIT1.0~1.15-----PQW256 (binary)

## PLC software setting

### Setup the GSD in the S7-300 software

#### Procedure :

- (1) .Close all stations in "HW Config".
- (2) .And select "option"-->"setup GSD".
- (3) . In the "installation \*.GSD file" dialog box, select Source: folders contain \*. GSD file, or the STEP 7 project contain \*. GSD file
- (4) .Select one or more files from \*.GSD file list, and then click on "install" button.

Copy the icon (. BMP file) to the relevant path, such as BRIDGE product: Bitmap\_Device = "EVIEW", that copy the "EVIEW" BMP file to the relevant path: c:\siemens\step7\s7data\nsbmp or c:\siemens\cpbv51\bitmaps

After installation, you can find the appropriate symbol in "PROFIBUS DP\GATWAY".

#### Project configuration

- (1) Use the guide to set up projects in the s7-300 software.
- (2) Double click "DP" of "HW Config"->attribute->new

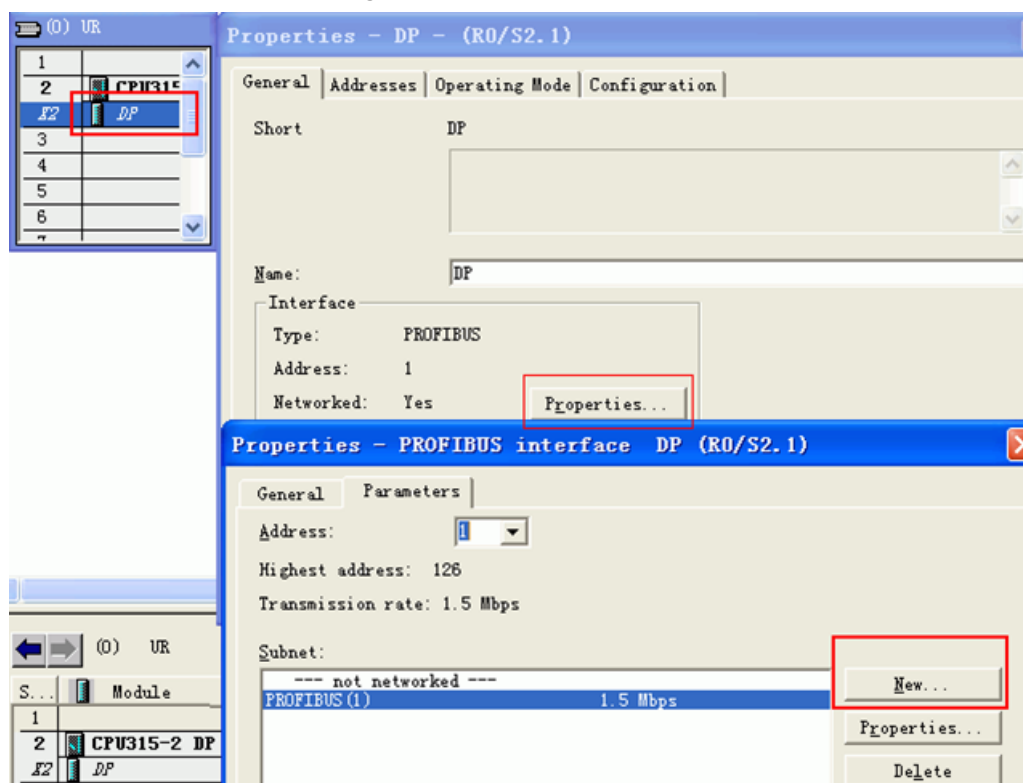

- (3) After press "ok", and then give a connection as follows:



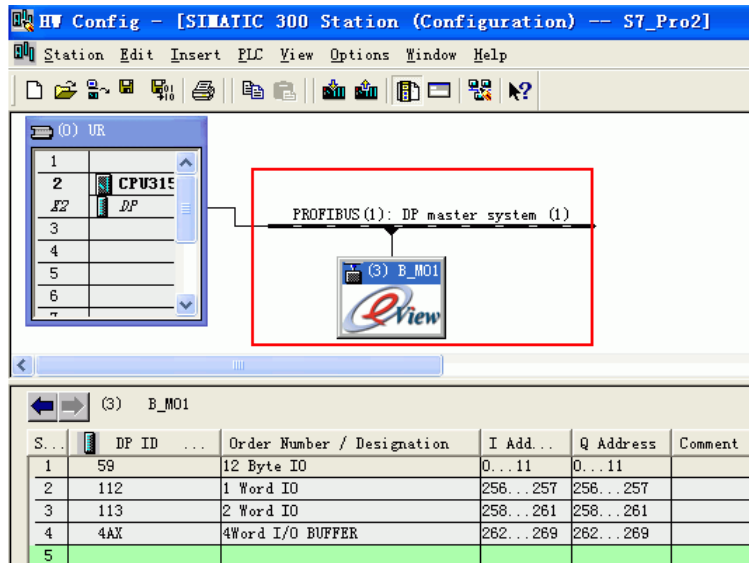

**NOTE:** the address of DP can't be the same as MPI's. Double click the address number to change.

(4) Double click "GATEWAY"->"eview"->"B\_MO1" to extend device.

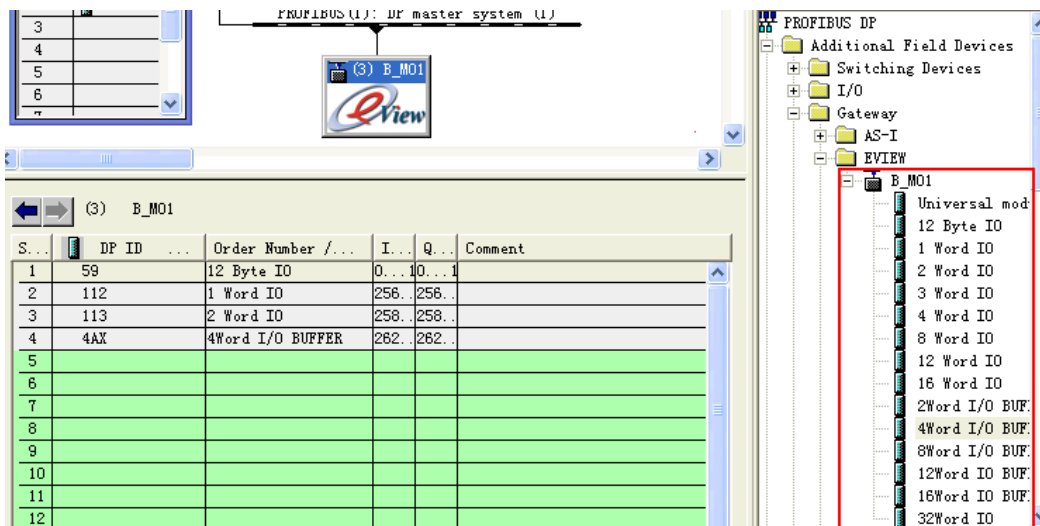

**NOTE:** for project configuration of BRIDGE, you must configure DI/DO resource of 12 bytes firstly. AI/AO is optional.

(5) Must Use OB82,OB86,OB100,OB121,OB122 in the ladder program of the external device, otherwise you need to manually operate the RUN switch of the external device as "RUN,STOP,RUN" in this order upon restart the display or PLC. When you use those special OB block, the communication will be automatically recovered even if you restart the display or PLC.

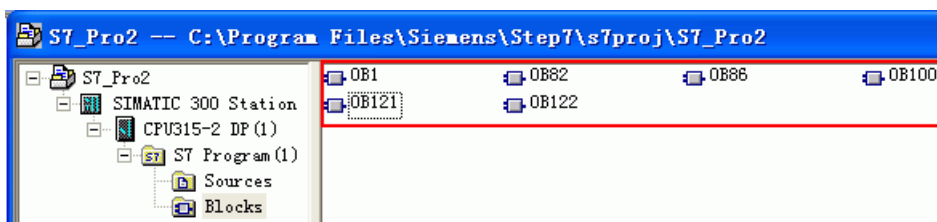

(6) Save and compile, and download to module, then the light of profibus is on.

(7) After configuration, and then you can program.

Bus Bridge setting:

(1) Setting ID of Profibus by switching 8-bit Dip(DIP1 is lowest bit, DIP8 is highest bit),range is from 3 to 125;

ID must be the same as its configuration in Siemens software. As above picture for example, setting is “3”, that the switch DIP1 and DIP2 on the panel of profibus are set ON, others are OFF.

(2) Profibus support baudrate as follows: 9.6Kbit/s, 19.2Kbit/s, 45.45Kbit/s, 93.75Kbit/s, 187.5Kbit/s, 0.5Mbit/s, 1.5Mbit/s, 3Mbit/s, 6Mbit/s, 12Mbit/s, and interface is automatically adaptive.

(3) A cable (purple),connect DP interface of s7-300 and bus bridge of profibus. Two sides have active terminal resistors; Switch on the s7-300 PLC is off, on the busbridge is on.

(4) Setting baudrate of modbus by switching DIP1-3 of modbus ID port, support 8 kinds of baudrate .Setting as follows:

1	2	3	Baud
OFF	OFF	OFF	1200
ON	OFF	OFF	2400
OFF	ON	OFF	4800
ON	ON	OFF	9600
OFF	OFF	ON	19200
ON	OFF	ON	38400
OFF	ON	ON	57600
ON	ON	ON	115200

(5) Setting station number of modbus by switching DIP4-8 of modbus ID port ,support 1 to 30 kinds of station number(DIP4 is lowest bit,DIP8 is highest bit, if DIP4 is on and DIP5~8 is off, it means station number is 00001,that is No. 1 station).

### ◎ Cable Diagram

#### RS232 communication cable

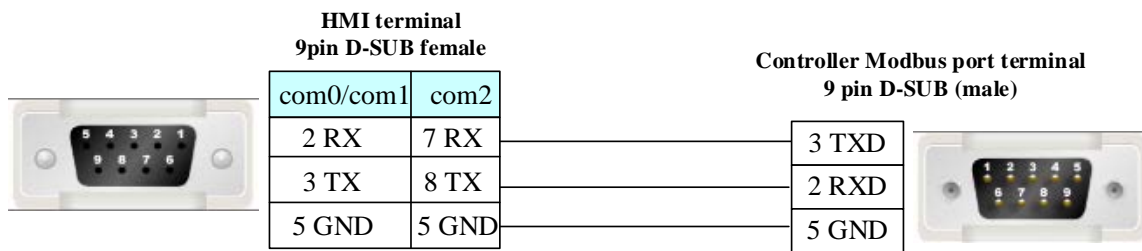

#### RS422 communication cable

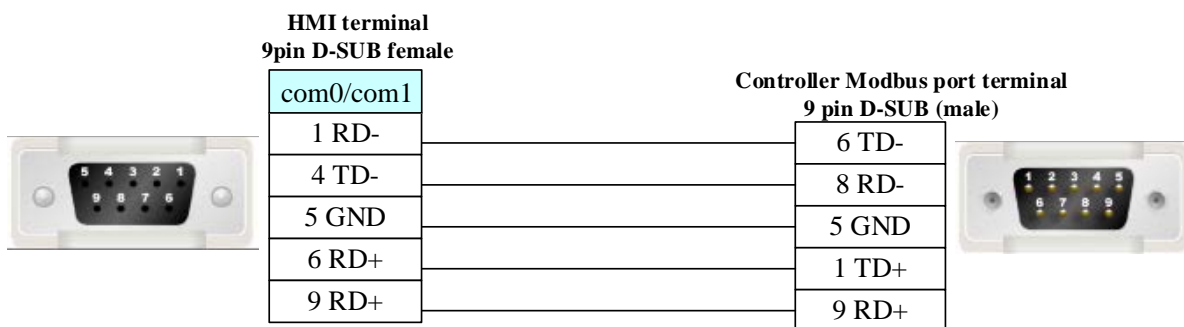

### RS485 communication cable

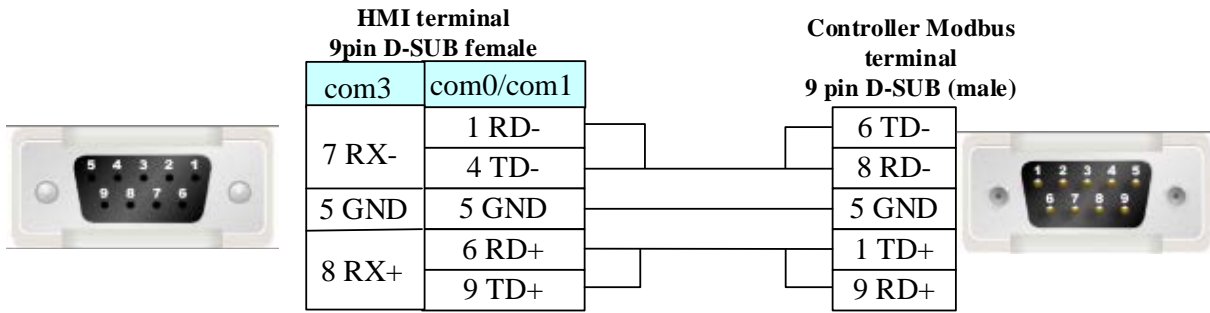

## 4.40 Kinco Servo Series

### Serial Communication

Series	CPU	Link Module	Driver
ED	ED100	RS232 on the CPU unit	Kinco Servo Series
	ED430	RS485 on port	
	ED620		
	ED630		
CD	CD420	RS232 on the CPU unit	
	CD430		
	CD620		

### System configuration

Series	CPU	Link Module	COMM Type	Parameter	Cable
ED	ED100	RS232 on the CPU unit	RS232	<a href="#">Setting</a>	<a href="#">Your owner cable</a>
	ED430	RS485 on port	RS485	<a href="#">Setting</a>	<a href="#">Your owner cable</a>
	ED620				
	ED630				
CD	CD420	RS232 on the CPU unit	RS232	<a href="#">Setting</a>	<a href="#">Your owner cable</a>
	CD430				
	CD620				

### Communication Setting

Default communication: 9600, 8, none, 1; staion: 1

#### RS232 communication

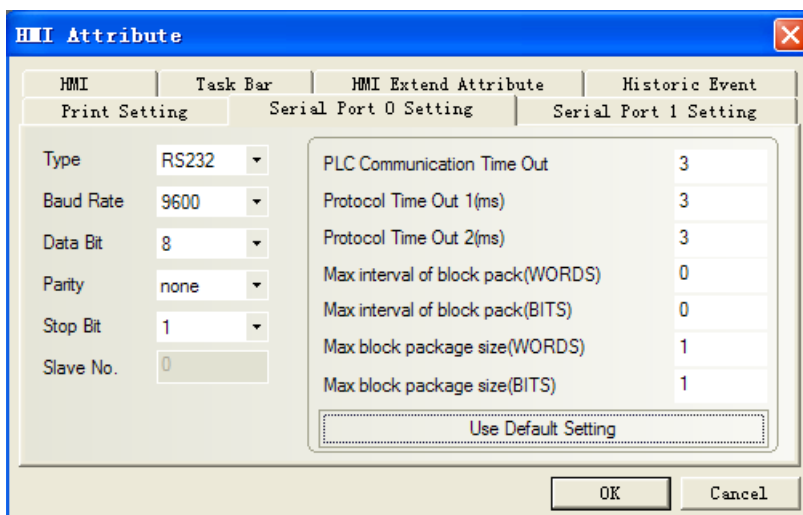

**NOTE:** If the servo controller to modify the station number, the servo power needed to restart, the station number to take effect, otherwise the communication is incorrect.

**RS485 communication**

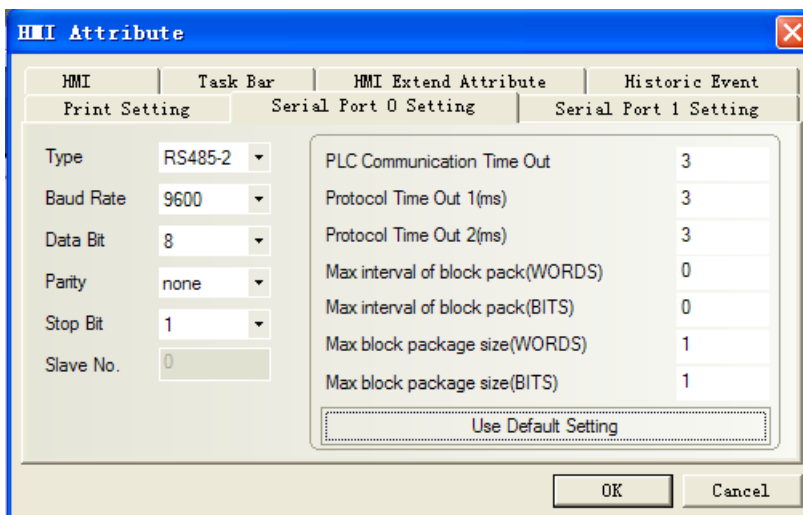

**© Supported Device**

Device	Bit Address	Word Address	Range	Notes
Dword	————	20	Refer to the kinco manual	
word	————	10	Refer to the kinco manual	
word	————	8	Refer to the kinco manual	
Dword	————	TBL	Refer to the kinco manual	

**NOTE:** Use the touch screen, pay attention to the rules addressing. The specific reference to the following description.

Touch-screen type of address: according to the number of bits to the servo. Can only be 20, 10, 8.

Address of the touch screen: master address, and sub address

For example, kinco servo drive manual on page 117, the address 2509, sub-address 06, median 20, addressing the touch screen as shown:

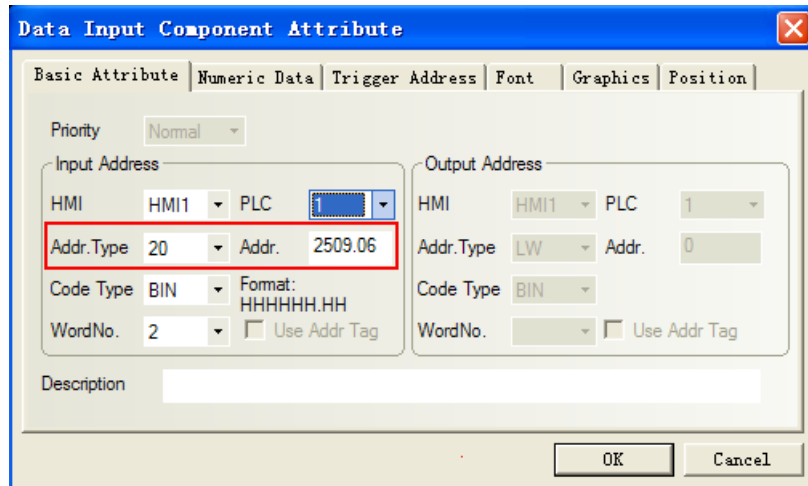

### ◎ Cable Diagram

#### ED Series

##### RS232 communication cable

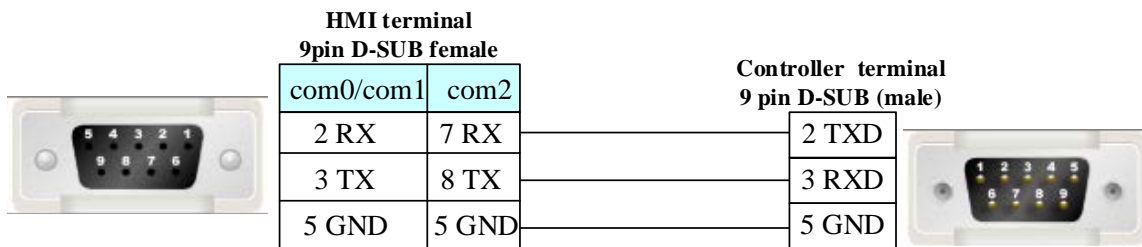

##### RS485 communication cable

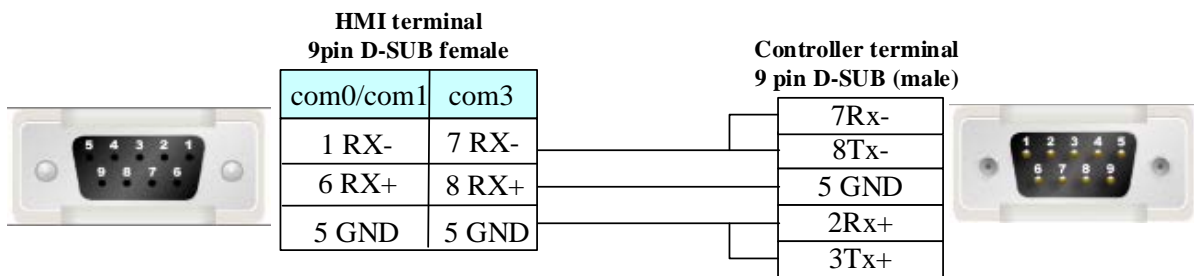

#### CD Series

##### RS232 communication cable

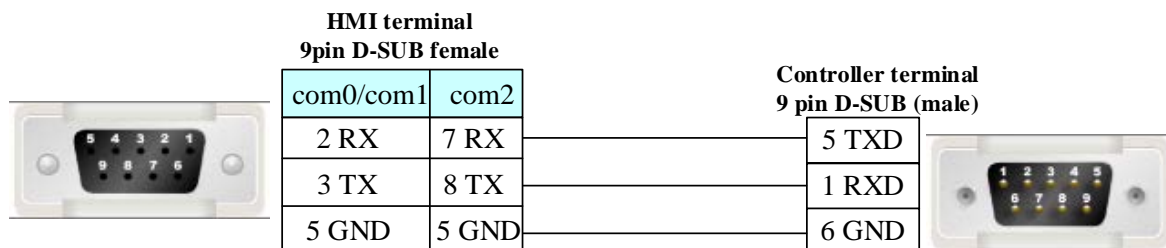

## 4.41 Kinco Master & Kinco Slave(Master/Slave Protocol Connection)

### ◎Serial Communication

Series	CPU	Link Module	Driver
Kinco Master			Kinco Master
Kinco Slave			Kinco Slave

### ◎System configuration

Series	CPU	Link Module	COMM Type	Parameter	Cable
Kinco Master				<a href="#">Setting</a>	<a href="#">Your owner cable</a>
Kinco Slave				<a href="#">Setting</a>	<a href="#">Your owner cable</a>

### ◎Communication Setting

#### Kinco Master

The screenshot shows the 'HMI Attribute' dialog box with the 'Serial Port 0 Setting' tab selected. The 'Type' is set to RS232, Baud Rate to 9600, Data Bit to 8, Parity to even, Stop Bit to 1, and Slave No. to 0. The 'PLC Communication Time Out' is 1, 'Protocol Time Out 1(ms)' is 50000, 'Protocol Time Out 2(ms)' is 0, 'Max interval of block pack(WORDS)' is 2, 'Max interval of block pack(BITS)' is 2, 'Max block package size(WORDS)' is 56, and 'Max block package size(BITS)' is 128. There is a 'Use Default Setting' button and 'OK'/'Cancel' buttons at the bottom.

#### Kinco Slave

The screenshot shows the 'HMI Attribute' dialog box with the 'Serial Port 0 Setting' tab selected. The 'Type' is set to RS232, Baud Rate to 9600, Data Bit to 8, Parity to even, Stop Bit to 1, and Slave No. to 1. The 'PLC Communication Time Out' is 1, 'Protocol Time Out 1(ms)' is 50000, 'Protocol Time Out 2(ms)' is 0, 'Max interval of block pack(WORDS)' is 2, 'Max interval of block pack(BITS)' is 2, 'Max block package size(WORDS)' is 56, and 'Max block package size(BITS)' is 128. There is a 'Use Default Setting' button and 'OK'/'Cancel' buttons at the bottom.

## ◎ Supported Device

Device	Bit Address	Word Address	Format	Notes
	B0 - 8999	-----	DDDD	
	-----	W0 - 8999	DDDD	

## ◎ Cable Diagram



## 4.42 Keyence Corporation

### ◎ Serial Communication

Series	CPU	Link Module	Driver
KV-16DT	KV-16DT	CPU Direct	<a href="#">Keyence KV-16DT</a>
KV-1000	KV-1000	CPU Direct	<a href="#">Keyence KV-1000</a>
KV-3000	KV-3000	CPU Direct	<a href="#">Keyence KV-3000</a>
KV-Nano Series	KV-N60AT	CPU Direct	<a href="#">Keyence KV-N60AT/7000</a>

### ◎ Network communication

Series	CPU	Link Module	Driver
KV-5000	KV-5000	CPU Direct	<a href="#">Keyence KV-5000/7000 EtherNet Slave</a>
KV-7000	KV-7500	CPU Direct	

### ◎ Serial System configuration

Series	CPU	Link Module	COMM Type	Parameter	Cable
KV-16DT	KV-16DT	CPU Direct	RS232	<a href="#">Setting</a>	<a href="#">Your owner cable</a>
KV-1000	KV-1000	CPU Direct	RS232	<a href="#">Setting</a>	<a href="#">Your owner cable</a>
KV-3000	KV-3000	CPU Direct	RS232	<a href="#">Setting</a>	<a href="#">Your owner cable</a>
KV-Nano Series	KV-N60AT	CPU Direct	RS232	<a href="#">Setting</a>	<a href="#">Your owner cable</a>
			RS485		<a href="#">Your owner cable</a>

### ◎ Network System configuration

Series	CPU	Link Module	Connect Type	Parameter	Cable
KV-5000	KV-5000	CPU Direct	Ethernet	<a href="#">Setting</a>	<a href="#">Your owner cable</a>
KV-7000	KV-7500	CPU Direct	Ethernet		

## ◎ Serial Communication Setting

### Keyence KV-16DT protocol

Default communication: 9600, 8, 1, even; station: 0

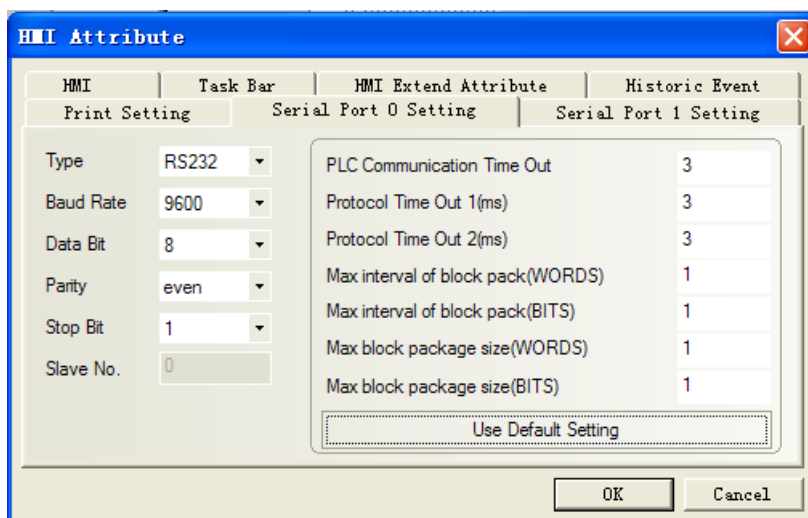

### Keyence KV-1000 protocol

Default communication: 9600, 8, 1, even; station: 0

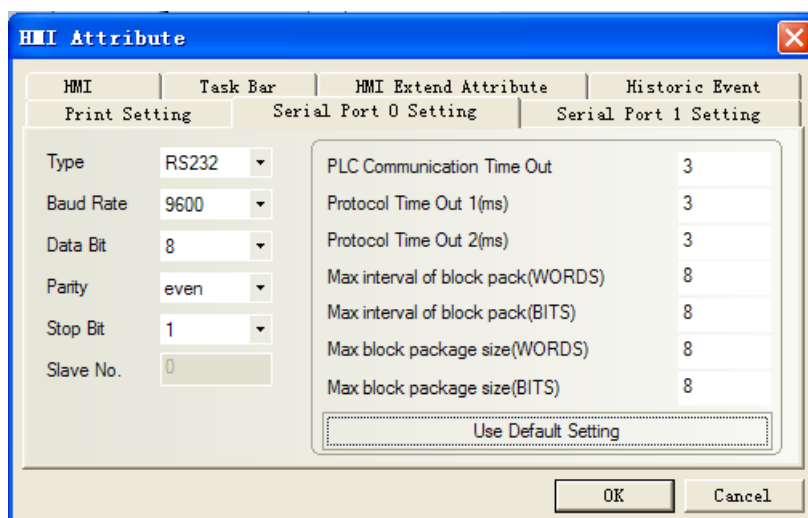

### Keyence KV-3000 protocol

Default communication: 9600, 8, 1, even; station: 0(Don't support station No.)



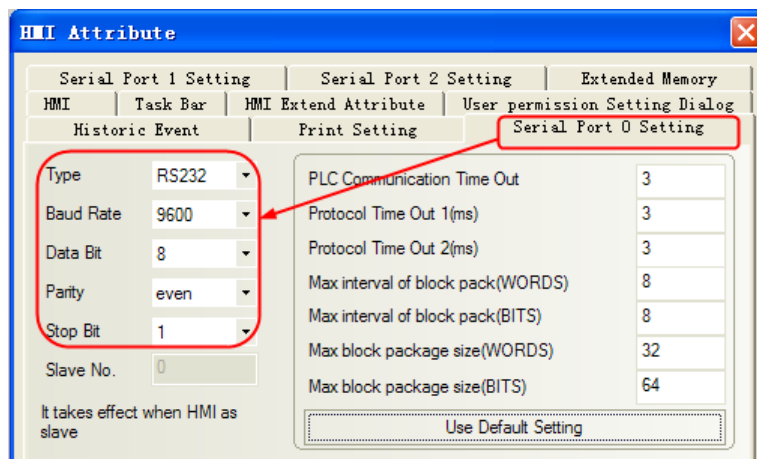

### Keyence KV-N60AT protocol

Default communication parameters, 9600bps, 8, even, 1,; station NO: 0  
**RS232**

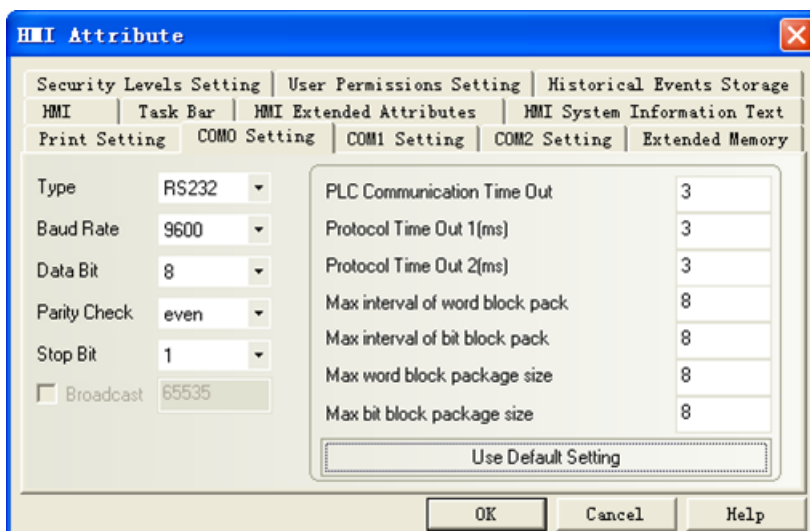

### PLC setting

1. In the [Confirm unit setting information] dialog box click [Yes], and the [Unit Editor] window will display. On the [Select unit] tab, from the displayed list of units select “KV-N60”, then drag &drop to the unit placement area. Configure the setup items as follows.

Operation Mode: KV STUDIO mode; Baud Rate: 9600 bps.

**Note: 1. Timer and counter register must be programmed in the KV STUDIO software before it be used in the HMI.**

**2. If the communication is slower, you can change the baud rate and the Protocol time out 1(ms)**

## © Network Communication Setting

### Keyence KV-5000/7000 EtherNet Slave protocol

#### HMI Setting

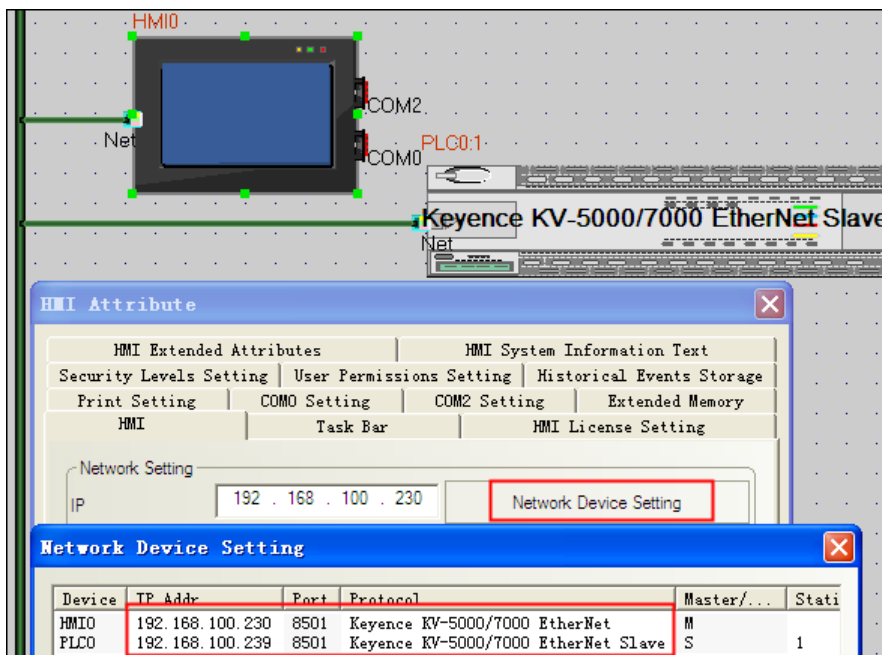

### PLC configuration

1. "Editor" window, click [Configure unit] in the "[0] KV-5000 R30000" to modify the IP address of the PLC, PLC and PC in the same segment, modify the IP address of the test shown, click [confirm] to save the modifications

2. Switch to the "Monitor" window to see the changes of the figure will pop up window, Click [PLC transfer -> Monitor mode (T)], pop-up "transmission program [communication goals: KV-5000 path: USB]", Click [implementation], content writing, once again view the "[0] KV-5000 R30000" in the PLC's IP address in the "Monitor" window [unit configuration], This indicates that the address has been modified over.

## © Supported Device

### KV-16DT

Device	Bit Address	Word Address	Format
Counter Relay	Counter_contact0- 59915	-----	DDDDD
Timer Relay	Timer_contact0- 65535	-----	DDDDD
High speed counter	CTH_contact0- 511	-----	DDD
High speed counter Comparator	CTC_contact0- 511	-----	DDD
Relay	Relay0- 32766	-----	DDDDD
Counter current	-----	Counter_current0- 3915	DDDD
Counter preset	-----	Counter_preset0- 65535	DDDDD
Timer current	-----	Timer_current0- 65534	DDDDD
Timer preset	-----	Timer_preset0- 11998	DDDDD
High speed counter	-----	CTH_current0- 65534	DDDDD
High speed counter	-----	CTH_preset0- 32766	DDDDD
High speed counter Comparator	-----	CTC_current0-65534	DDDDD
High speed counter Comparator	-----	CTC_preset0- 32766	DDDDD

Data memory	-----	DM0- 32766	DDDDD
Temporary data memory	-----	TM0- 32766	DDDDD

**Note:** Non-supported batch transfer of bits or words for this protocol.

### KV-1000

Device	Bit Address	Word Address	Format	Notes
Relay	R0-599.15	-----	DDDDD	
Control Relay	CR0-39.15	-----	DDDD	
Internal auxiliary relay	MR0-999.15	-----	DDDDD	
Latch Relay	LR0-999.15	-----	DDDDD	
Data Memory	-----	DM0-65534	DDDDD	
Control Memory	-----	CM0-11998	DDDDD	
Temporary data memory	-----	TM0-511	DDD	
Extended Data memory	-----	EM0-65534	DDDDD	
Extended Data memory	-----	FM0-32766	DDDDD	

### KV-3000

Device	Bit Address	Word Address	Format	Notes
Relay	R0-999.15	-----	DDD.DD	
Control Relay	CR0-39.15	-----	DD.DD	
Internal auxiliary relay	MR0-999.15	-----	DDD.DD	
Latch Relay	LR0-999.15	-----	DDD.DD	
Data Memory	-----	DM0-65534	DDDDD	
Control Memory	-----	CM0-5999	DDDD	
Temporary data memory	-----	TM0-511	DDD	
Extended Data memory	-----	EM0-65534	DDDDD	
Extended Data memory	-----	FM0-32767	DDDDD	

**Note:** PLC bit address without a decimal point in the distinction, in fact, the last two addresses corresponding to the fractional part, makes a distinction between the touch screen.

模块/宏	软元件	当前值	显示格式
全局	R000	-	1 位二进制数
全局	R001	-	1 位二进制数
全局	R002	-	1 位二进制数
全局	R003	-	1 位二进制数
全局	R004	-	1 位二进制数
全局	R005	-	1 位二进制数
全局	R006	-	1 位二进制数
全局	R007	-	1 位二进制数
全局	R008	-	1 位二进制数
全局	R009	-	1 位二进制数
全局	R010	-	1 位二进制数
全局	R011	-	1 位二进制数
全局	R012	-	1 位二进制数
全局	R013	-	1 位二进制数
全局	R014	-	1 位二进制数
全局	R015	-	1 位二进制数
全局	R100	-	1 位二进制数
全局	R101	-	1 位二进制数
全局	R102	-	1 位二进制数
全局	R103	-	1 位二进制数
全局	R104	-	1 位二进制数
全局	R105	-	1 位二进制数
全局	R106	-	1 位二进制数
全局	R107	-	1 位二进制数
全局	R108	-	1 位二进制数
全局	R109	-	1 位二进制数
全局	R110	-	1 位二进制数
全局	R111	-	1 位二进制数
全局	R112	-	1 位二进制数
全局	R113	-	1 位二进制数
全局	R114	-	1 位二进制数
全局	R115	-	1 位二进制数
全局	R200	-	1 位二进制数

Example, PLC which corresponds to R009, the touch screen address is R0.09; PLC which corresponds to R015, the touch screen address is R0.15.

### KV-5000/7000

Device	Bit Address	Word Address	Format	Notes
Relay	R0-999.15	-----	DDD.DD	
Control Relay	CR0-79.15	-----	DD.DD	
Internal auxiliary relay	MR0-999.15	-----	DDD.DD	
Latch Relay	LR0-999.15	-----	DDD.DD	
Timer	T0~3999	-----	DDD	
Counter	C0~3999	-----	DDDD	
Data Relay	DM_bit 0~65535.15	-----	DDDDD.DD	
	CTC_contact 0~4	-----	D	
	CTH_contact 0~1	-----	D	
Link Relay	B 0~7FFF	-----	HHHH	
	VB 0~F9FF	-----	HHHH	
Timer(Setting Value)	-----	CTC_preset 0~4	D	
Timer(Current Value)	-----	CTC_current 0~4	D	
Counter(Setting Value)	-----	CTH_preset 0~1	D	
Counter(Current Value)	-----	CTH_current 0~1	D	

Data Memory	-----	DM0-65534	DDDDD	
Control Memory	-----	CM0-5999	DDDD	
Temporary data memory	-----	TM0-999	DDD	
Extended Data memory	-----	EM0-65534	DDDDD	
Extended Data memory	-----	FM0-32767	DDDDD	
File Memory	-----	ZF 0~524287	DDDDDD	
	-----	VM 0~59999	DDDDD	
Link Memory	-----	W 0~7FFF	HHHH	
Timer current	-----	TC 0-3999	DDDD	
Timer set	-----	TS 0-3999	DDDD	
Counter current	-----	CC 0-3999	DDDD	
Counter set	-----	CS 0-3999	DDDD	

Note: PLC bit address without a decimal point in the distinction, in fact, the last two addresses corresponding to the fractional part, makes a distinction between the touch screen.

#### KV-N60AT

Device	Bit Address	Word Address	Format	Notes
Relay	R0-599.15	-----	DDD.DD	
Control Relay	CR0-89.15	-----	DD.DD	
Internal auxiliary relay	MRO-599.15	-----	DDD.DD	
Latch Relay	LR0-199.15	-----	DDD.DD	
Link Relay	B0-1FFF	-----	HHHH	
Work Relay	VB0-1FFF	-----	HHHH	
	CTC_contact 0~4	-----	D	
	CTH_contact 0~1	-----	D	
Counter	-----	CC0-3999	DDD	
Timer	-----	TC0-3999	DDD	
	-----	CTC_preset 0~4	D	
	-----	CTC_current 0~4	D	
	-----	CTH_preset 0~1	D	
	-----	CTH_current 0~1	D	
Data Memory	-----	DM0-65534	DDDDD	
Control Memory	-----	CM0-8999	DDDD	
Temporary data memory	-----	TM0-511	DDD	
Link register	-----	W0-7FFF	HHHH	
	-----	VM0-59999	DDDDD	
File register	-----	ZF0-131071	DDDDDD	
Extend data memory	-----	FM0-32767	DDDDD	
Extend data memory	-----	EM0-65534	DDDDD	

#### © Cable Diagram

### KV Series RS232 communication cable

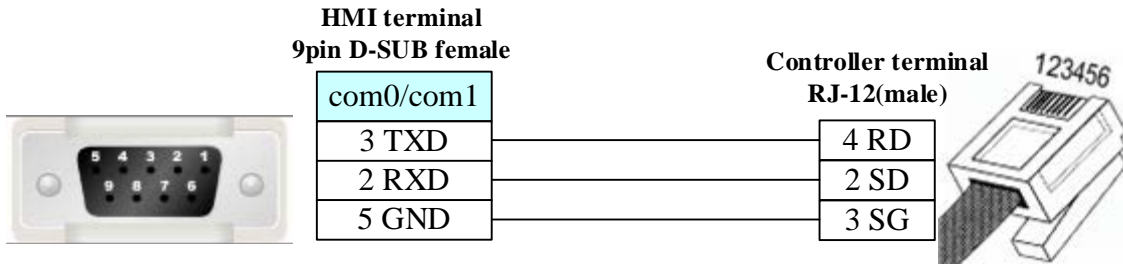

### KV Series RS485 communication cable

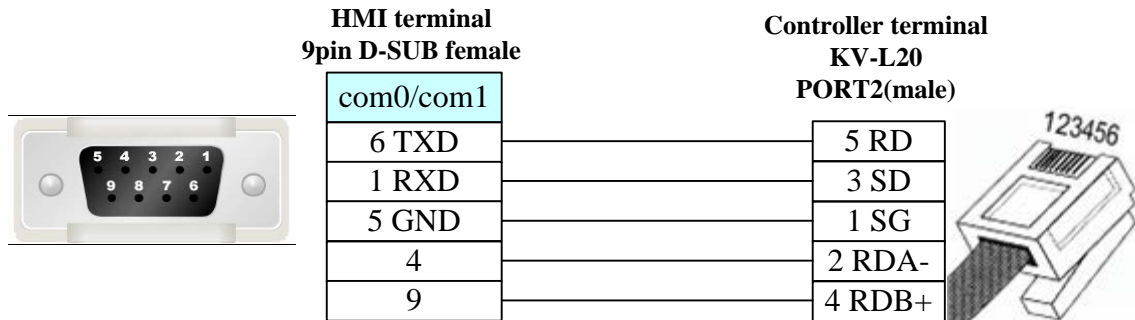

### KV L20 module RS232 communication cable

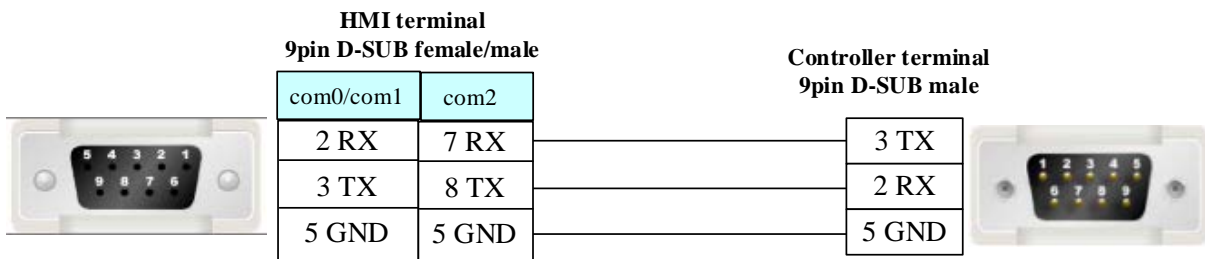

### KV L20 module RS422 communication cable

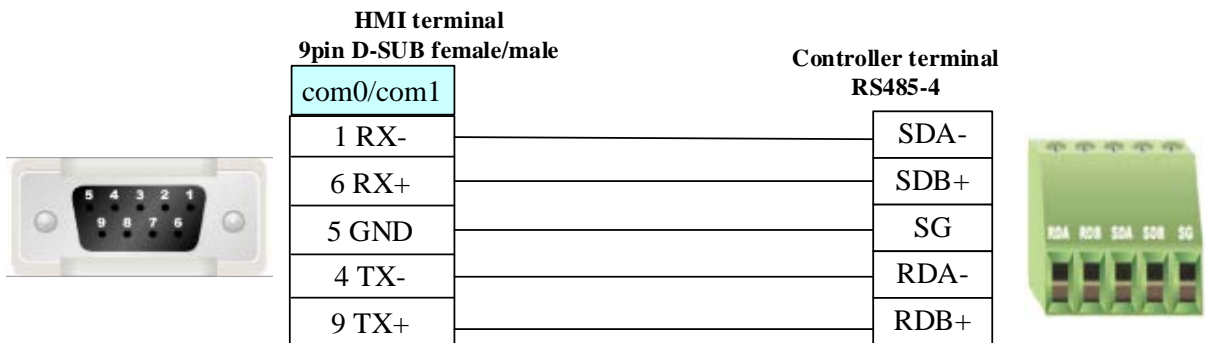

### KV L20module RS485-2 communication cable

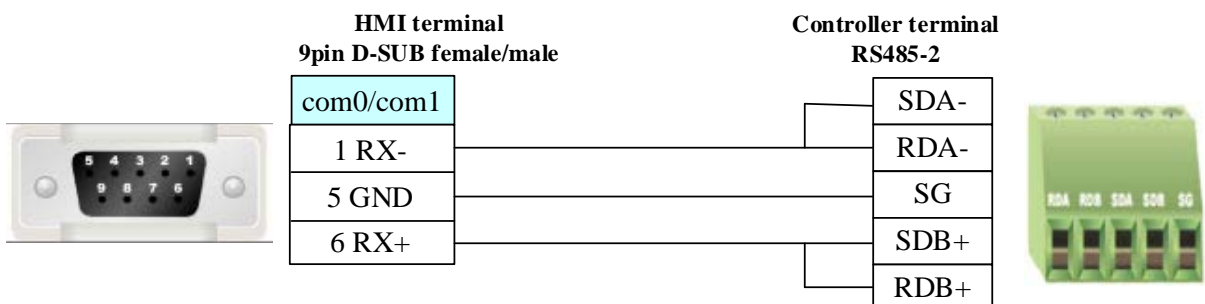

### Ethernet communication protocol cable

Cross-connection or crossover network cable can be used as communication cable via the hub

Refer to [3.3 Download by Network Ethernet](#) for method of making connection cable.

## 4.43 Koyo Corporation

### ◎ Serial Communication

Series	CPU	Link Module	Driver
KOYO DIRECT	SM24-T	RS232 on the CPU unit	Koyo Direct
	DL06	RS232 on the port1	
	DL105		
	DL230	RS232\RS422 on the port2	
	DL240		
	DL250		
	DL350		
	DL450		

### ◎ Network Communication

Series	CPU	Link Module	Driver
KOYO	NK1	CPU Direct	Koyo NK1 Ethernet(TCP Slave)

### ◎ System configuration

Series	CPU	Link Module	COMM Type	Parameter	Cable
KOYO DIRECT	SM24-T	RS232 on the CPU unit	RS232	<a href="#">Setting</a>	<a href="#">Your owner cable</a>
			RS485	<a href="#">Setting</a>	<a href="#">Your owner cable</a>
	DL05 DL06 DL105 DL230 DL240 DL250 DL350 DL450	RS232 on the port1	RS232	<a href="#">Setting</a>	<a href="#">Your owner cable</a>
			RS232	<a href="#">Setting</a>	<a href="#">Your owner cable</a>
		RS232 on the port2	RS232	<a href="#">Setting</a>	<a href="#">Your owner cable</a>
			RS422	<a href="#">Setting</a>	<a href="#">Your owner cable</a>

### ◎ Network configuration

Series	CPU	Link Module	Connect Type	Parameter	Cable
KOYO	NK1	CPU Direct	Ethernet	<a href="#">Setting</a>	<a href="#">Your owner cable</a>

### ◎ Series Communication Setting

#### KOYO series RS232 communication setting

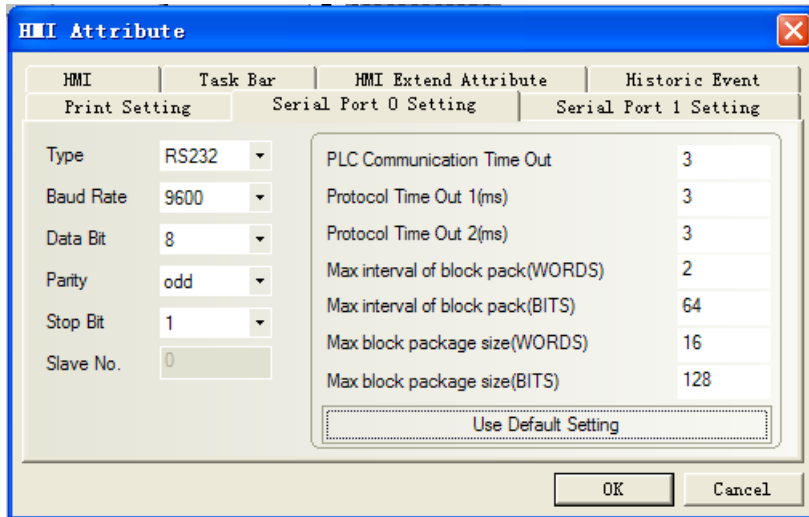

**KOYO series RS485 communication setting**

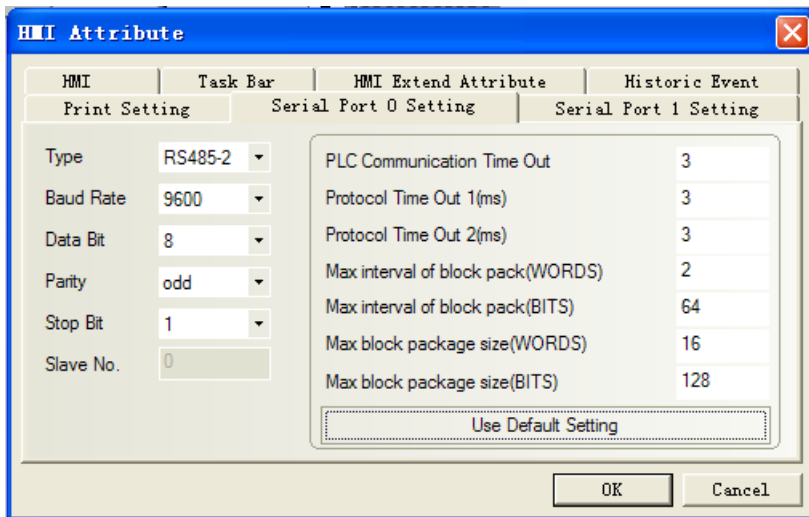

**KOYO DL06 series RS422 communication setting**

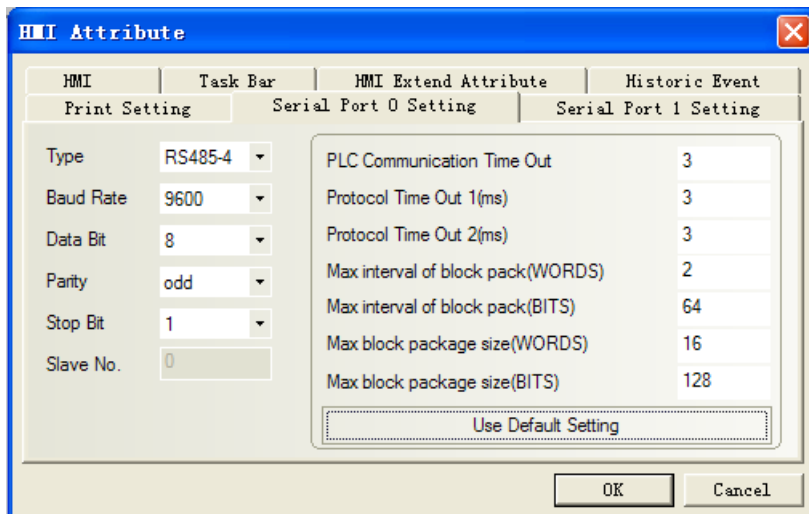

**PLC software setting**



1. The security password function must be disabled.
2. The COM port must adopt K sequence protocol.
3. Set the switch of the CPU with working mode setting switch to the TERM state.

## ◎ Network Communication Setting

### HMI Setting

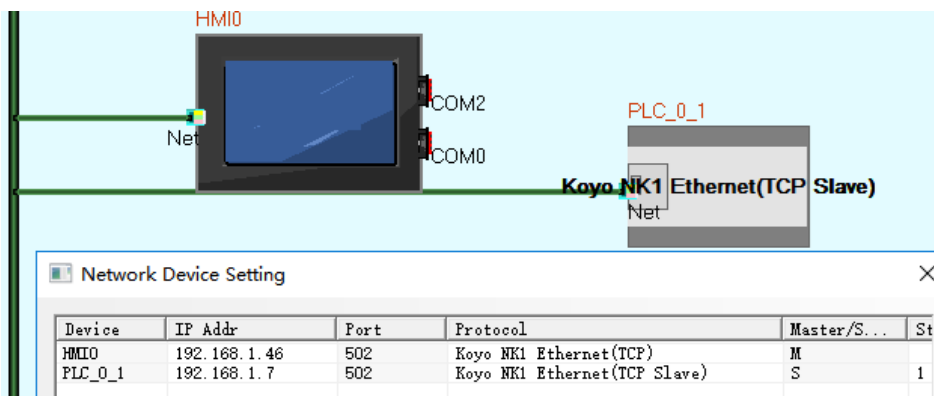

### PLC Setting



## ◎ Supported Device

### Koyo Direct

Device	Bit Address	Word Address	Format	Notes
Input	I(X) 0-77777	-----	00000	
Output	Q(Y) 0-77777	-----	00000	
variable	M(C) 0-77777	-----	00000	
Timer Status	T(T) 0-77777	-----	00000	
Counter Status	C(CT) 0-77777	-----	00000	
Input	GX 0-10000	-----	00000	
Output	GY 0-10000	-----	00000	

	S 0-2000	-----	0000	
	SP 0-2000			
Data Register	-----	R(V) 0-77777	00000	
Counter	-----	Counter 0-2000	0000	
Timer	-----	Timer 0-2000	0000	

**Koyo NK1 Ethernet(TCP Slave)**

Device	Bit Address	Word Address	Format	Notes
Input	I 0-1777	-----	00000	
Output	Q 0-1777	-----	00000	
variable	M 0-3777	-----	00000	
Timer Status	T 0-777	-----	00000	
Counter Status	C 0-777	-----	00000	
Input	GI 0-3777	-----	00000	
Output	GQ 0-3777	-----	00000	
	S 0-1777	-----	0000	
	SP 0-1777	-----	0000	
Data Register	-----	R 0-37777	00000	

**© Cable Diagram**

**KOYO SM24-T series RS232 communication cable**

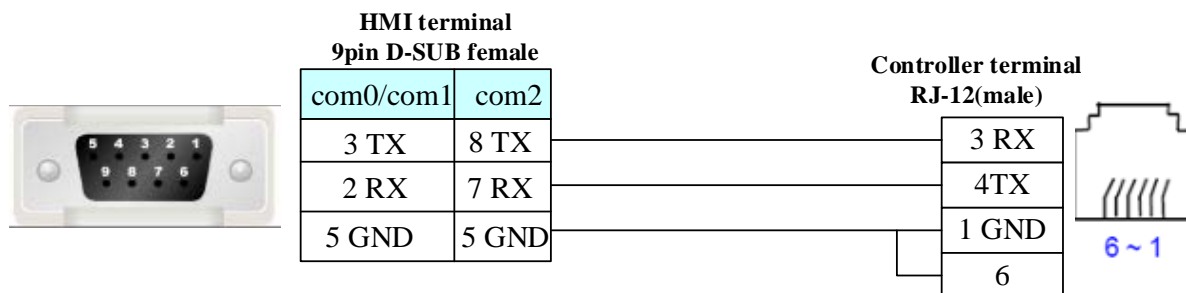

**KOYO SM24-T series RS485 communication cable**

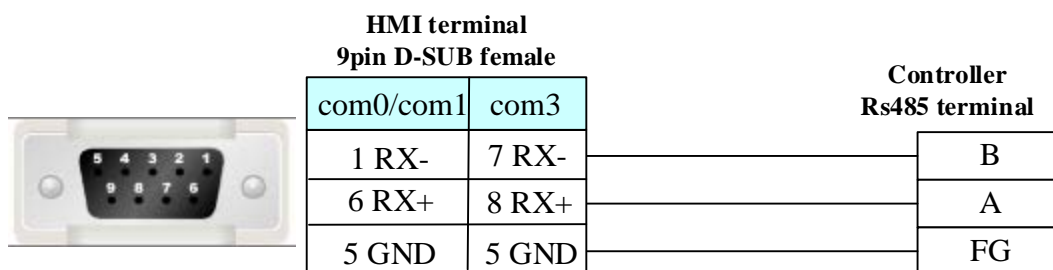

**KOYO DL06 series RS232 communication cable**

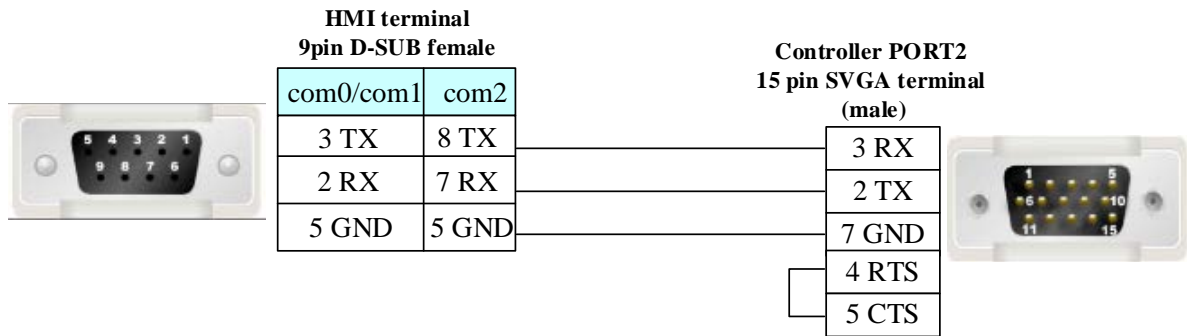
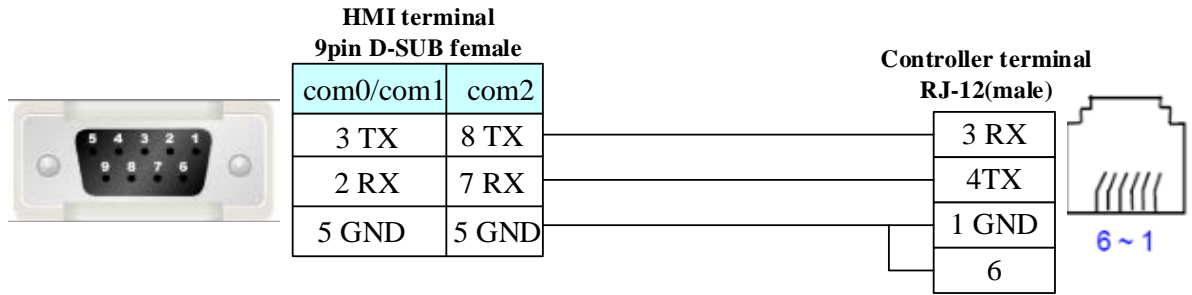

**KOYO DL06 series RS422 communication cable**

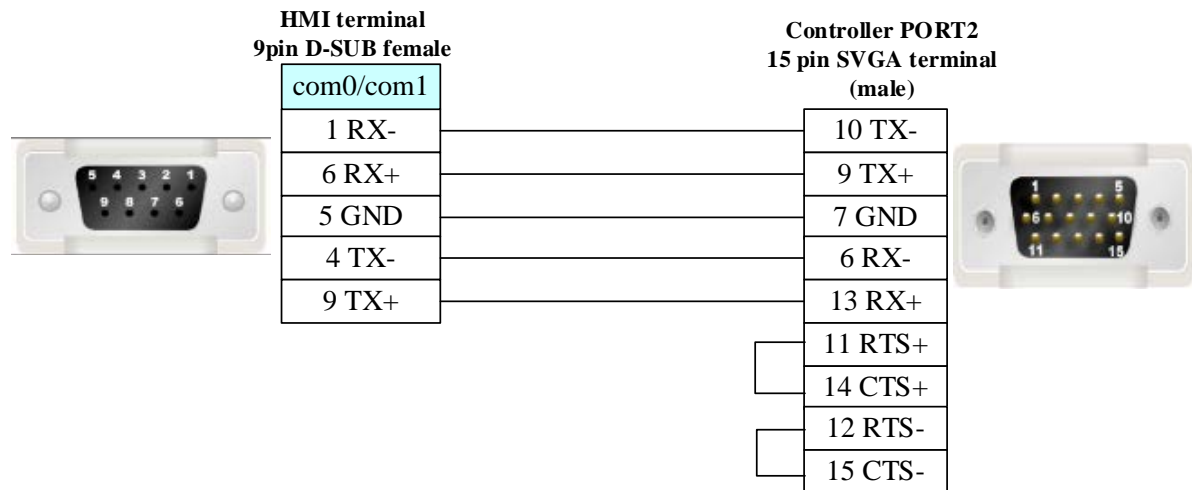

**Ethernet communication protocol cable**

Cross-connection or crossover network cable can be used as communication cable via the hub  
 Refer to [3.3 Download by Network Ethernet](#) for method of making connection cable.

**4.44 KTC Srdlink**

**Serial Communication**

Series	CPU	Link Module	Driver
SRD	SRD2211	RS232 on CPU unit	KTC SRDLINK

		RS485 on CPU unit	
COM	COM2023	RS232 on CPU unit	
		RS485 on CPU unit	

### ◎ System configuration

Series	CPU	Link Module	COMM Type	Parameter	Cable
SRD	SRD2211	RS232 on CPU unit	RS232	<a href="#">Setting</a>	<a href="#">Your owner cable</a>
		RS485 on CPU unit	RS485	<a href="#">Setting</a>	<a href="#">Your owner cable</a>
COM	COM2023	RS232 on CPU unit	RS232	<a href="#">Setting</a>	<a href="#">Your owner cable</a>
		RS485 on CPU unit	RS485	<a href="#">Setting</a>	<a href="#">Your owner cable</a>

### ◎ Communication Setting

#### KTC RS232 communication

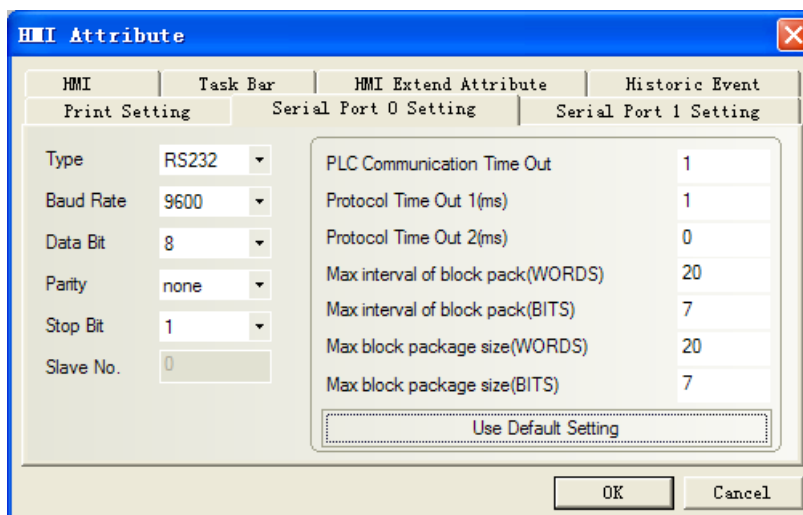

#### KTC RS485 communication

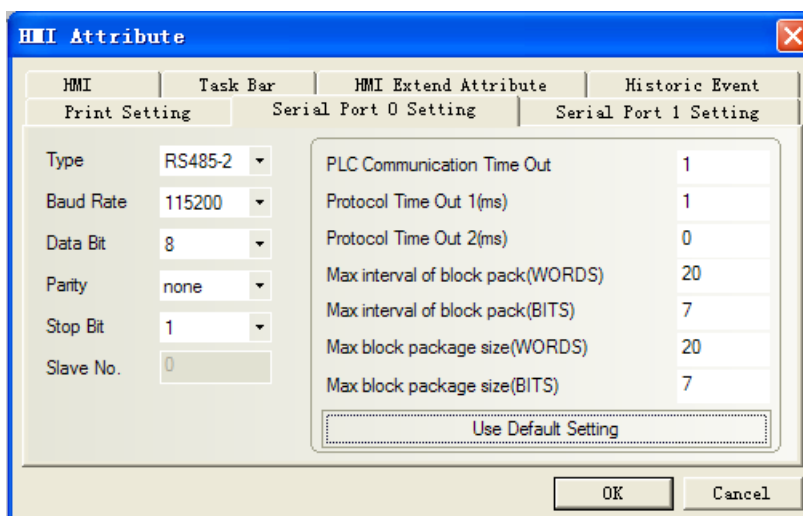

**NOTE:** Must modify communication parameter in the programming software.

### ◎ Supported Device

Please refer to the PLC manual for details.

### ◎ Cable Diagram

#### KTC RS232 communication cable

Direct connect (cable by KTC Corporation)

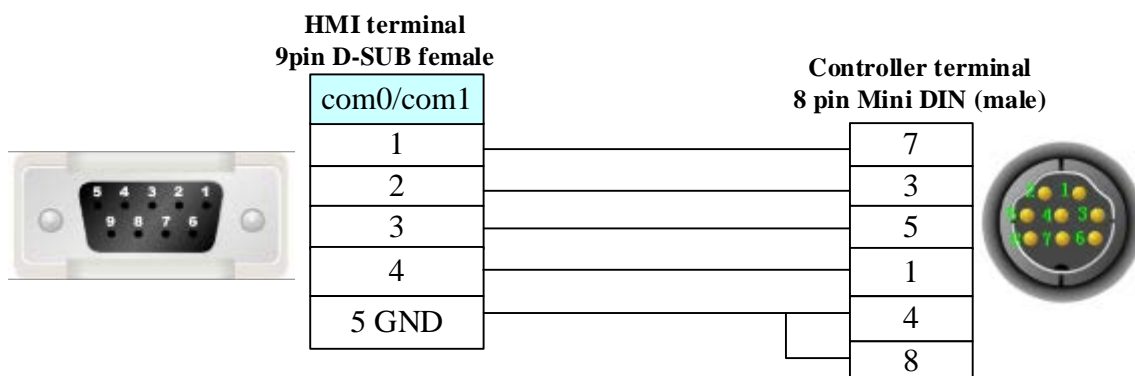

#### KTC RS485 communication cable

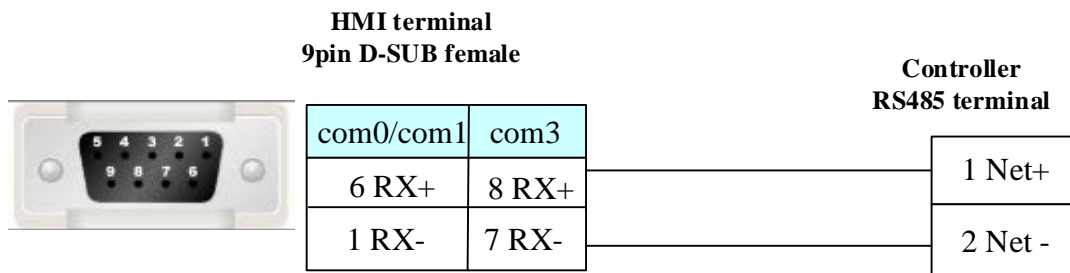

## 4.45 KYL Slave

### ◎ Serial Communication

Series	CPU	Link Module	Driver
KYL Slave	KYL	RS232 on the CPU unit	KYL Slave

### ◎ System configuration

Series	CPU	Link Module	COM Type	Parameter	Cable
KYL Slave	KYL	RS232 on the CPU unit	RS232	<a href="#">Setting</a>	<a href="#">Your owner cable</a>

### ◎ Communication Setting

RS232

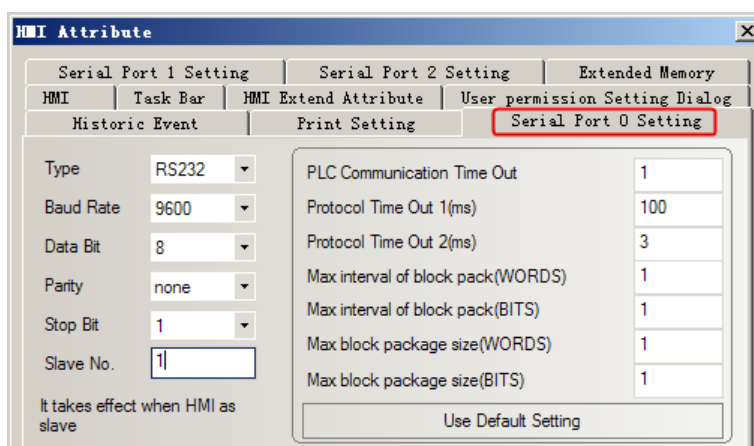

### ◎ Supported Device

Device	Bit Address	Word Address	Format	Notes
Group close instruction	LB0	-----	DD	Station:1; LB address
Remote valve open operation	LB1	-----	DD	
Remote valve close operation	LB2	-----	DD	
Remote valve address set operation	LB3	-----	DD	
Set gain current state	LB4	-----	DD	
flase valve open	LB8	-----	DD	
flase valve close	LB9	-----	DD	
valve open feedback	LB10	-----	DD	
valve close feedback	LB11	-----	DD	
valve uncap alarm	LB12	-----	DD	
valve hypopiesis alarm	LB13	-----	DD	
Show current valve state	LB14	-----	DD	
Show valve state	LB15	-----	DD	
Group close instruction	LB17	-----	DD	
Remote valve open operation	LB18	-----	DD	
Remote valve close operation	LB19	-----	DD	
Remote valve address set operation	LB20	-----	DD	
Set gain current state	LB24	-----	DD	
flase valve open	LB25	-----	DD	
flase valve close	LB26	-----	DD	
valve open feedback	LB27	-----	DD	
valve close feedback	LB28	-----	DD	
valve uncap alarm	LB29	-----	DD	
valve hypopiesis alarm	LB30	-----	DD	
Show current valve state	LB31	-----	DD	

### ◎ Cable Diagram

#### RS232

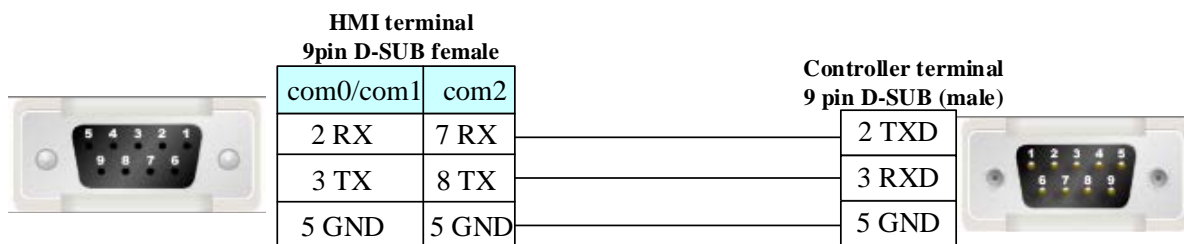

## 4.46 LENZE Inverter

### Serial Communication

Series	CPU	Link Module	Driver
Lenze Lecom A/B	EVF9323-EV	RS232 on the CPU unit	Lenze Lecom_AB

### System configuration

Series	CPU	Link Module	COM Type	Parameter	Cable
Lenze Lecom A/B	EVF9323-EV	RS232 on the CPU unit	RS232	<a href="#">Setting</a>	<a href="#">Your owner cable</a>
		RS485 on the CPU unit	RS485	<a href="#">Setting</a>	<a href="#">Your owner cable</a>

### Communication Setting

#### Lecom AB RS232 communication

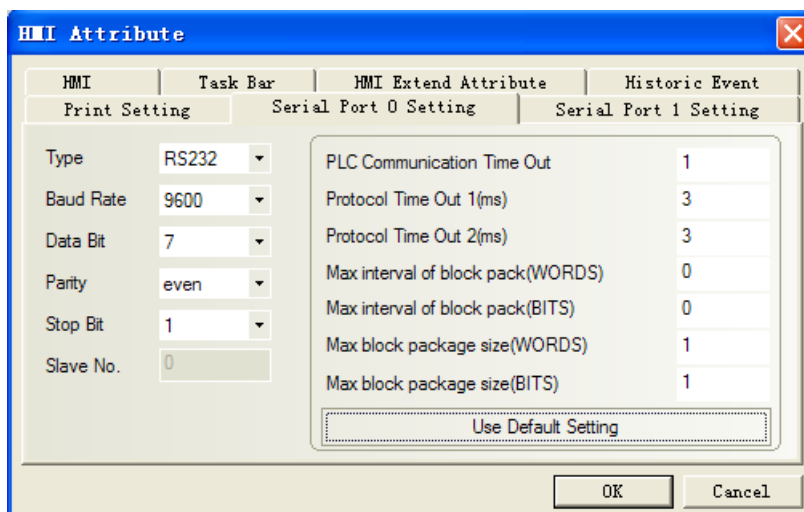

#### Lecom AB RS485 communication

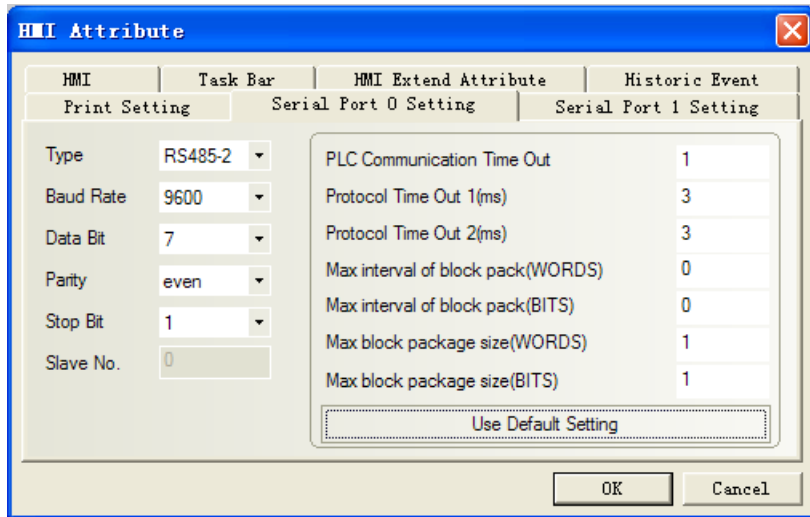

### ◎ Supported Device

Refer to the PLC software for details; Global drive control

- Note:** code\_H: Data type is HEX
- code\_F: Data type is Floating
- code\_D: Data type is Decimal

### ◎ Cable Diagram

#### Lecom AB RS232 communication cable

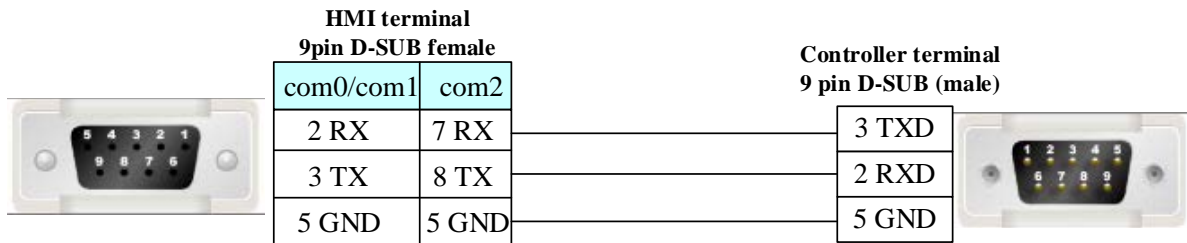

#### Lecom AB RS485 communication cable

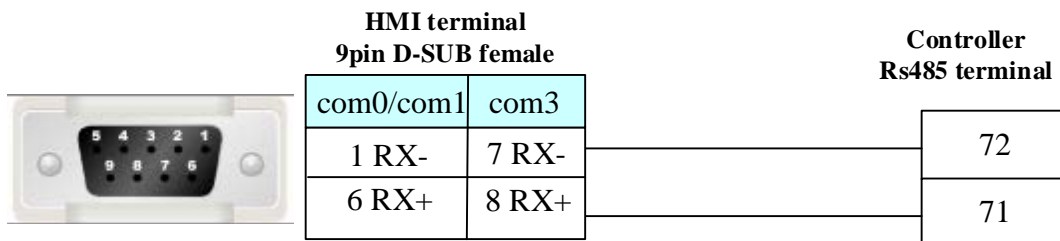



## 4.47 Liteon Corporation

### ◎ Serial Communication

Series	CPU	Link Module	Driver
ISA_7X	ISA_7X-100-A1	RS232 on the CPU unit	Liteon Servo Driver
		RS485 on the CPU unit	
EVO Series	EVO6000	RS232 on the CPU unit	Liteon Inverter Driver
	EVO6800	RS485 on the CPU unit	
	EVO8000		

### ◎ System configuration

Series	CPU	Link Module	COMM Type	Parameter	Cable
ISA_7X	ISA_7X-100-A1	RS232 on the CPU unit	RS232	<a href="#">Setting</a>	<a href="#">Your owner cable</a>
		RS485 on the CPU unit	RS485	<a href="#">Setting</a>	<a href="#">Your owner cable</a>
EVO Series	EVO6000	RS232 on the CPU unit	RS232	<a href="#">Setting</a>	<a href="#">Your owner cable</a>
	EVO6800 EVO8000	RS485 on the CPU unit	RS485	<a href="#">Setting</a>	<a href="#">Your owner cable</a>

### ◎ Communication Setting

#### Liteon Servo Driver protocol

##### HMI Setting

Default communication: 9600, 8, none, 2; station: 127

##### RS232 communication

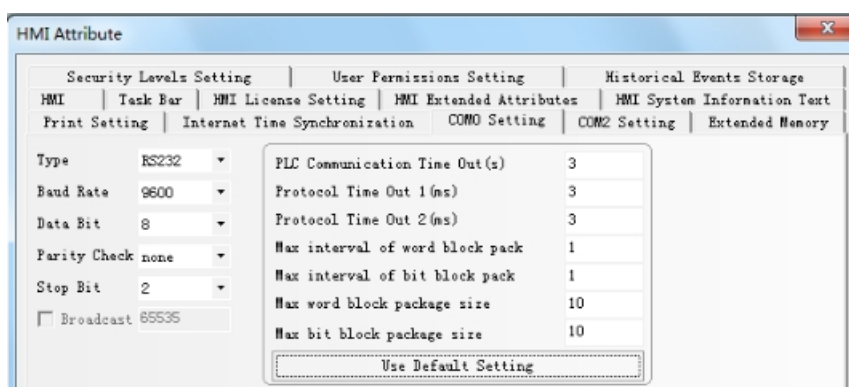

##### RS485 communication

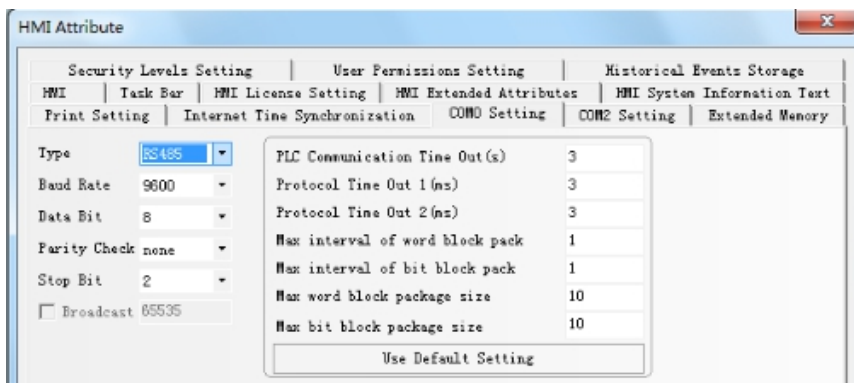

### PLC Setting

For related parameter settings, please refer to the relevant instructions of the communication equipment.

### Liteon Servo Driver protocol

#### HMI Setting

Default communication: 19200, 8, None, 1; station:1

#### RS232 communication

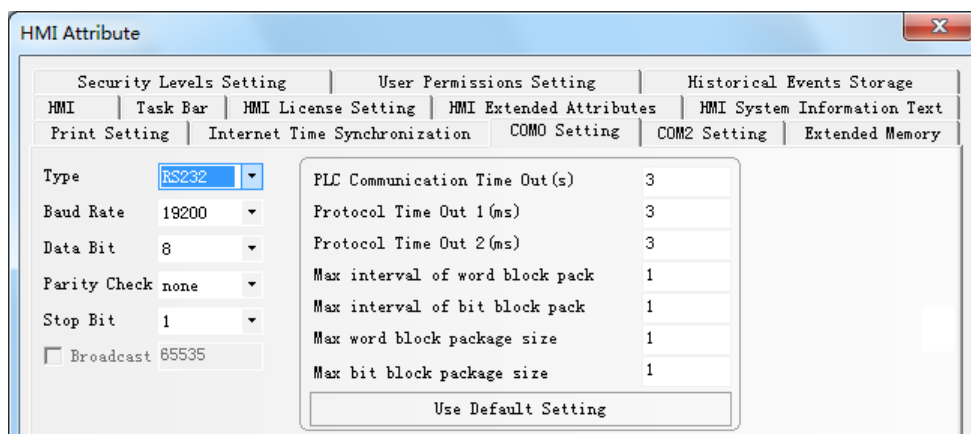

#### RS485 communication

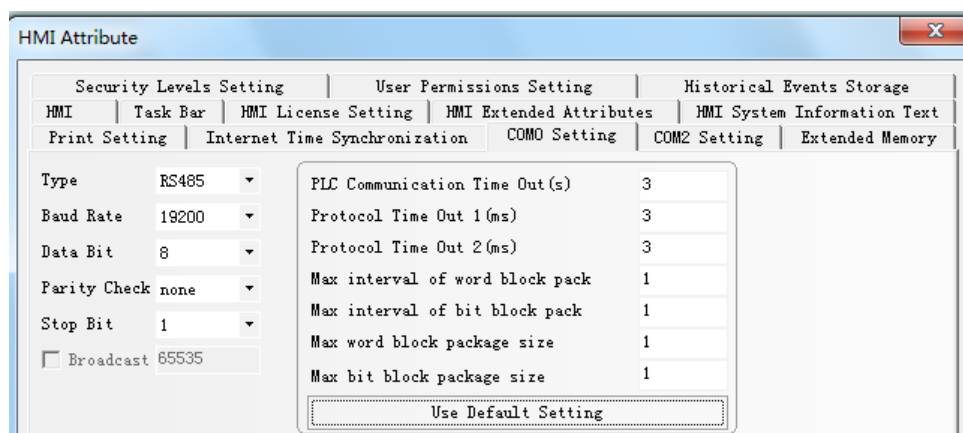

©Supported Device

### Liteon Servo Driver

Device	Bit Address	Word Address	Format	Notes
word	———	4X 0--91D	HHH	

### Liteon Inverter Driver

Device	Bit Address	Word Address	Range	Notes
word	———	4X0--FFFF	Refer to the Liteon manual	

## ◎ Cable Diagram

### RS232 communication cable

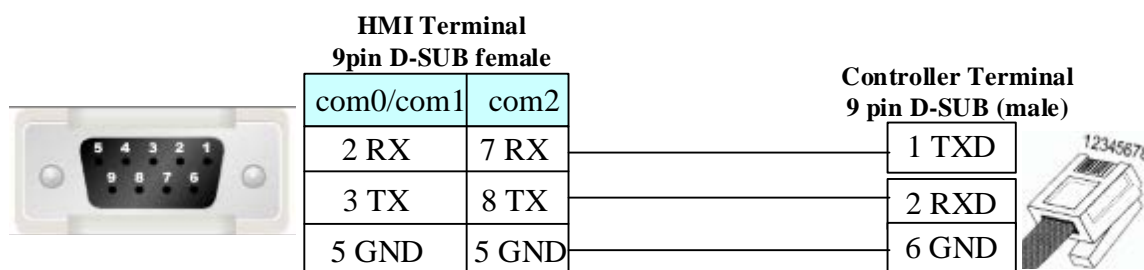

### RS485 communication cable

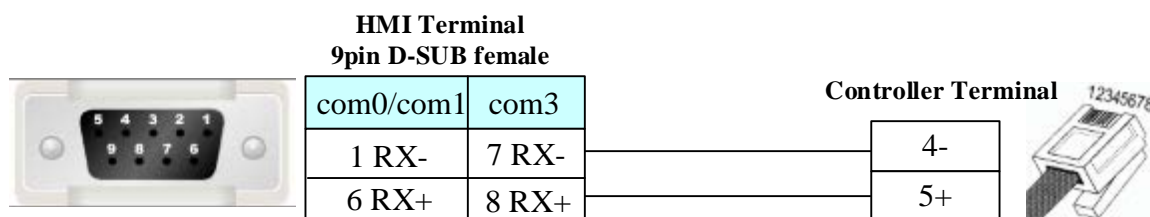

## 4.48 LS Industrial Systems (LG)

### ◎ Serial Communication

Series	Type	CPU	Link Module	Driver
Master-K	K120S	K7M-DR10UE K7M-DR20U K7M-DT30U K7M-DT40U K7M-DT60U	Port1 on CPU unit Port2 on CPU unit	LS Master-K CPU Direct LS Master-K Cnet LS Master-K Modbus RTU
	K200S	K3P-07AS	RS232 on the CPU unit	
XGT		XGK-CPUH	RS232 on the CPU unit	LS XBC/XGK CPU Direct
XGB		XBC-DN64H XBC-DR32H		

		XBC-DR40EB XBC-DN30S	Built-in RS-232C/RS-485	LS XBC/XGK Cnet
		XEC-DN20SU XEC-DR32H XEC-DN32UA	RS232 on the CPU unit	LS XEC CPU Direct
			Built-in RS-232C/RS-485	LS XEC CPU Cnet
GLOFA	GM	GM6	RS232 on the CPU unit	LS GLOFA Cnet
			G6L-CUEB	
			G6L-CUEC	
		GM7	RS232 on the CPU unit	
			G7L-CUEB	
			G7L-CUEC	
Inverter	iG5A	SV008iG5A-2	RS485on the CPU unit	LS iG5A
	iG5	SV004IG5-1	RS485 on the CPU unit	LS iG5
	C100	LV0002C100-2N	RS485on the CPU unit	LS C100 Series Inverter
	iGxA	SV008IGxA-4	RS485on the CPU unit	LS iGxA Series Inverter
	iS7	SV0550-0750iS7-4	RS485on the CPU unit	LS iS7 Series Inverter
	S100	LV0004S100-4EONNS	RS485on the CPU unit	LS S100 Series Inverter

#### The difference of LS Master-K CPU Direct、LS Master-K Cnet、LS Master-K Modbus RTU

Protocol	PLC Setting	Communication Mode	Multi-station	Baud(bps)
LS Master-K Cnet	Switch the DIP2 to be ON, DIP1 to be OFF	RS232/RS485	support	9600/19200 /38400
LS Master-K MODBUS RTU	Switch the DIP2 to be ON, DIP1 to be OFF	RS232/RS485	support	9600/19200 /38400
LS Master-K CPU Direct	Switch the DIP1 and DIP2 to be OFF	RS232	non-support	38400

#### ◎ Ethernet communication

Series	CPU	Link Module	Driver
GLOFA	GM6-CPUA	G6L-EUTP	LS GLOFA FEnet
XGT	XGK-CPUE	XGL-EFMT	LS XGT Ethernet
XGB	XBC-DR60SU	XBL-EMTA	LS XBC FEnet Slave

#### ◎ Serial System Configuration

Series	CPU	Link Module	COMM Type	Parameter	Cable
K120S	K7M-DR10UE	Port1 on CPU unit	RS232	<a href="#">Setting</a>	<a href="#">Your owner cable</a>
		Port2 on CPU unit	RS485	<a href="#">Setting</a>	<a href="#">Your owner cable</a>
	K7M-DR20U	Port1 on CPU unit	RS232	<a href="#">Setting</a>	<a href="#">Your owner cable</a>
		Port2 on CPU unit	RS485	<a href="#">Setting</a>	<a href="#">Your owner cable</a>
K200S	K3P-07AS	RS232 on the CPU unit	RS232	<a href="#">Setting</a>	<a href="#">Your owner cable</a>
XGT	XGK-CPUH	RS232 on the CPU unit	RS232	<a href="#">Setting</a>	<a href="#">Your owner cable</a>
XGB	XBC-DN64H XBC-DR32H	RS232 on the CPU unit	RS232	<a href="#">Setting</a>	<a href="#">Your owner cable</a>
		Built-in RS-232C	RS232	<a href="#">Setting</a>	<a href="#">Your owner cable</a>

	XBC-DR40EB XBC-DN30S	Built-in RS-485	RS485	<a href="#">Setting</a>	<a href="#">Your owner cable</a>
	XEC-DN20SU XEC-DR32H XEC-DN32UA	RS232 on the CPU unit	RS232	<a href="#">Setting</a>	<a href="#">Your owner cable</a>
		Built-in RS-232C	RS232	<a href="#">Setting</a>	<a href="#">Your owner cable</a>
GLOFA	GM6	RS232 on the CPU unit	RS232	<a href="#">Setting</a>	<a href="#">Your owner cable</a>
		G6L-CUEB			
		G6L-CUEC	RS422/RS485	<a href="#">Setting</a>	<a href="#">Your owner cable</a>
	GM7	RS232 on the CPU unit	RS232	<a href="#">Setting</a>	<a href="#">Your owner cable</a>
		G7L-CUEB			
		G7L-CUEC	RS422/RS485	<a href="#">Setting</a>	<a href="#">Your owner cable</a>
iG5A	SV008iG5A-2	on the CPU unit	RS485	<a href="#">Setting</a>	<a href="#">Your owner cable</a>
iG5	SV004iG5-1	R485 on the CPU unit	RS485	<a href="#">Setting</a>	<a href="#">Your owner cable</a>
C100	LV0002C100-2 N	on the CPU unit	RS485	<a href="#">Setting</a>	<a href="#">Your owner cable</a>

### ⊙ Ethernet System Configuration

Series	CPU	Link Module	COMM Type	Parameter	Cable
GLOFA	GM6-CPUA	ETH on the CPU unit	ETH	<a href="#">Setting</a>	<a href="#">Your owner cable</a>
XGT	XGK-CPUE	XGL-EFMT	ETH	<a href="#">Setting</a>	
XGB	XBC-DR60SU	XBL-EMTA	ETH	<a href="#">Setting</a>	

### ⊙ Serial Communication Setting

#### LS Master-K Cnet protocol

Default communication: 38400, 8, none , 1; station:1

#### HMI Setting

##### RS232 communication

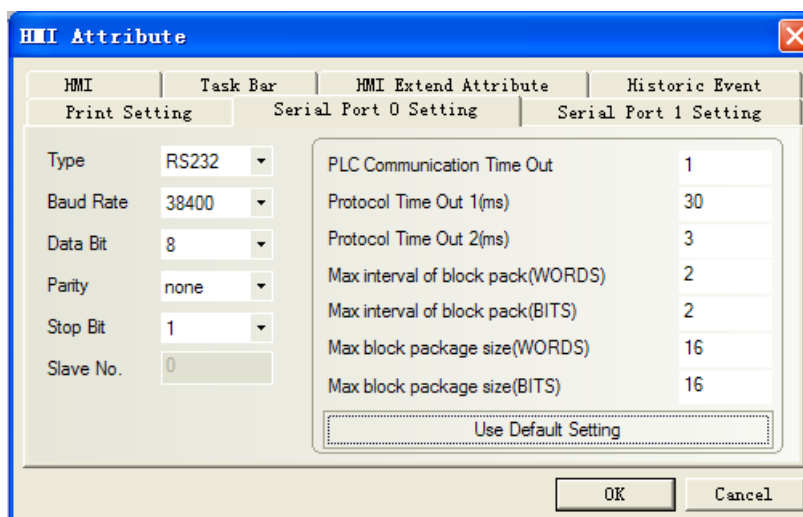

##### RS485 communication

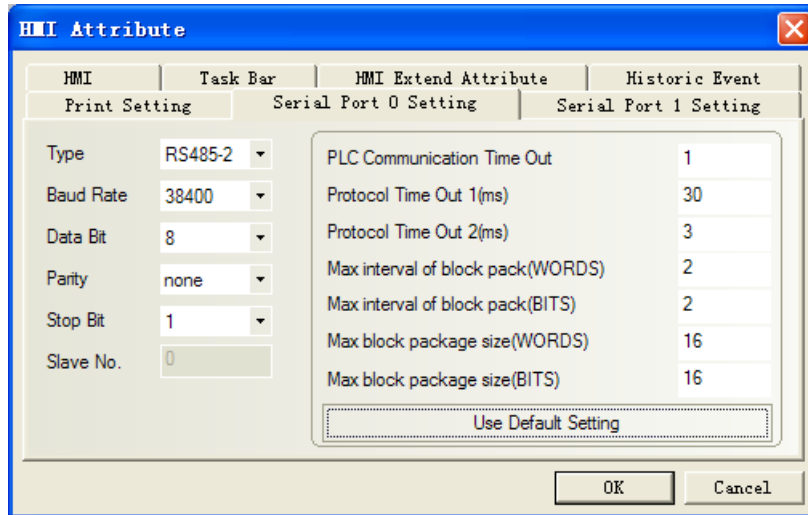

## PLC setting

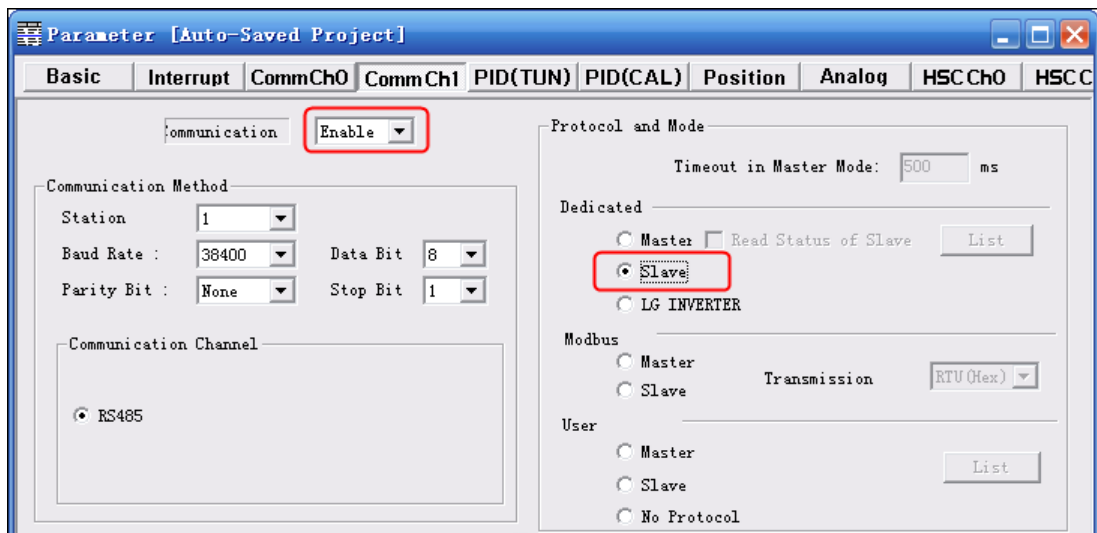

If click “Connect+Write+Run+Monitor Start”, it will give a “Cannot Change PLC Mode”. Need to let the run light go out by manual control, and then download. After download, let the run light keep on.

## LS Master-K CPU Direct protocol

### HMI Setting

Default communication: 38400, 8, none , 1; station:1

### RS232 communication

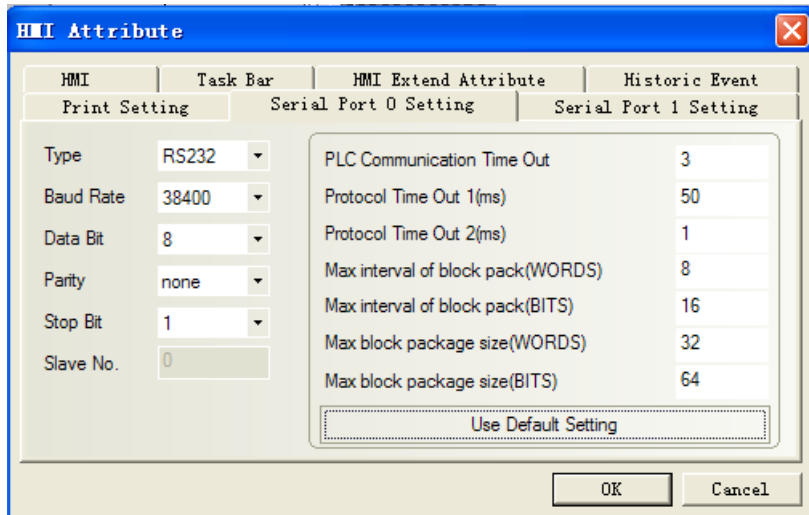

**NOTE:** Only support 38400 baud rate for the protocol

## LS Master-K Modbus RTU protocol

### HMI Setting

Default communication: 38400, 8, none , 1; station:1

### RS232 communication

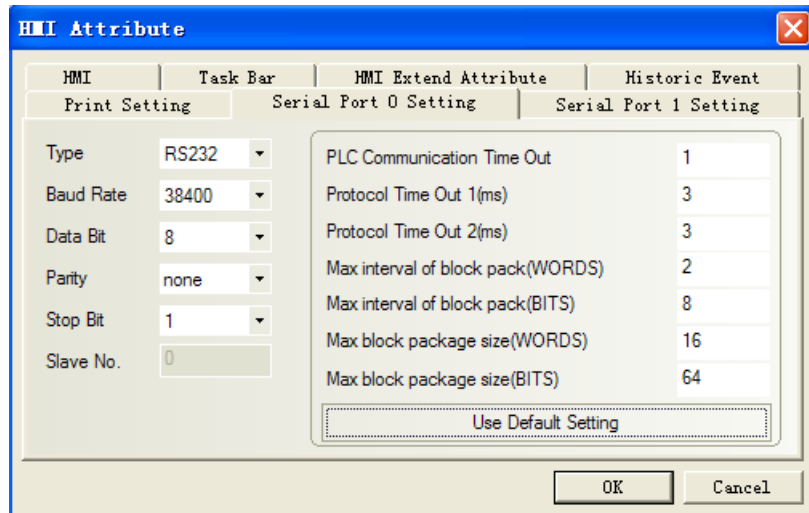

### PLC Setting

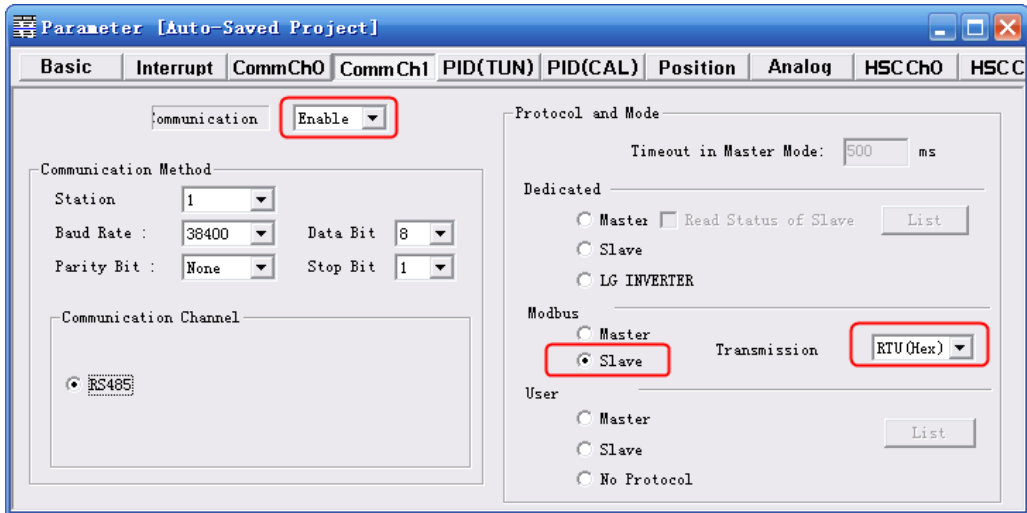

If click “Connect+Write+Run+Monitor Start”, it will give a “Cannot Change PLC Mode”. Need to let the run light go out by manual control, and then download. After download, let the run light keep on.

### LS XBC/XGK CPU Direct protocol

Default communication: 115200, 8, none, 1; station: 0

#### RS232 communication

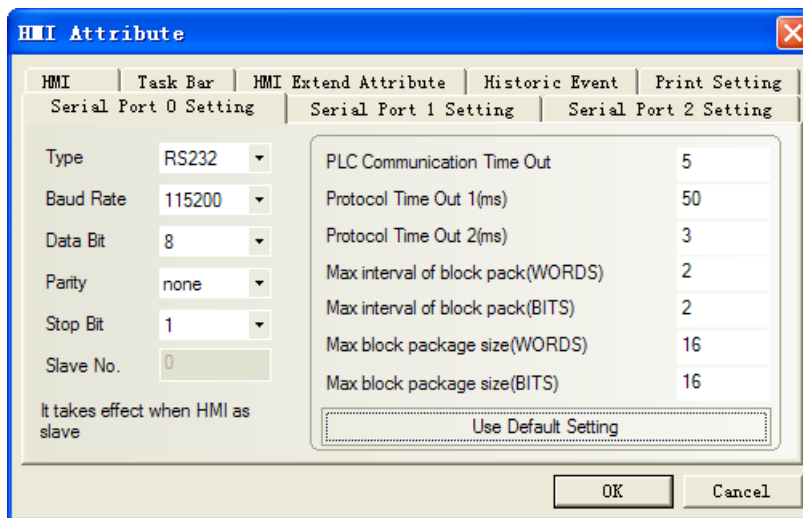

**NOTE:** Only support 115200 baud rate for the protocol; station number disable.

### LS XBC/XGK Cnet protocol

Default communication: 9600, 8, none, 1; station: 0

#### HMI Setting

#### RS232 communication



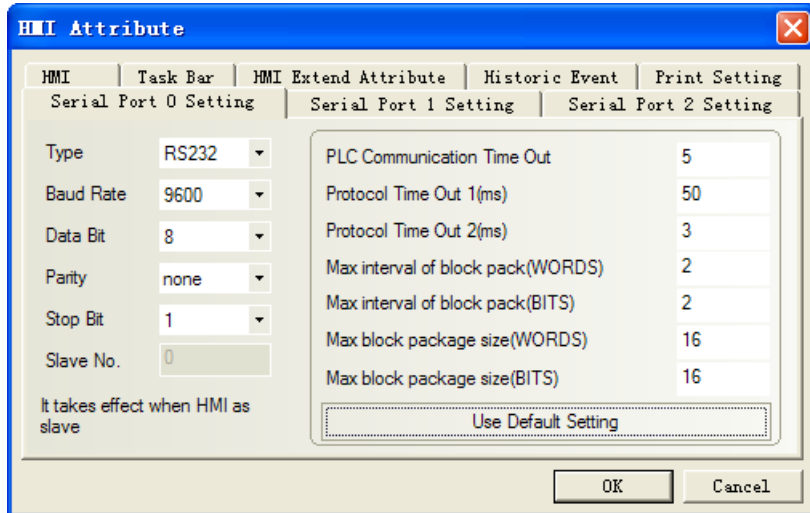

### RS485 communication

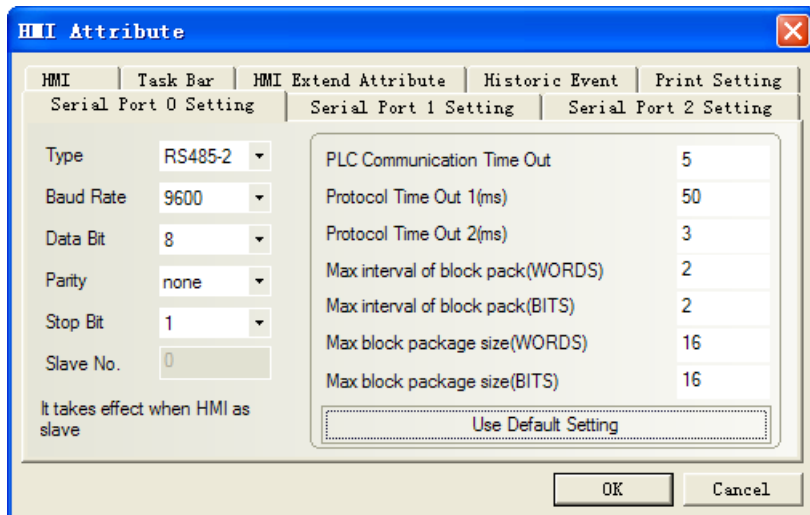

### PLC Setting

1. "Tools"---"Network Manager" set communication

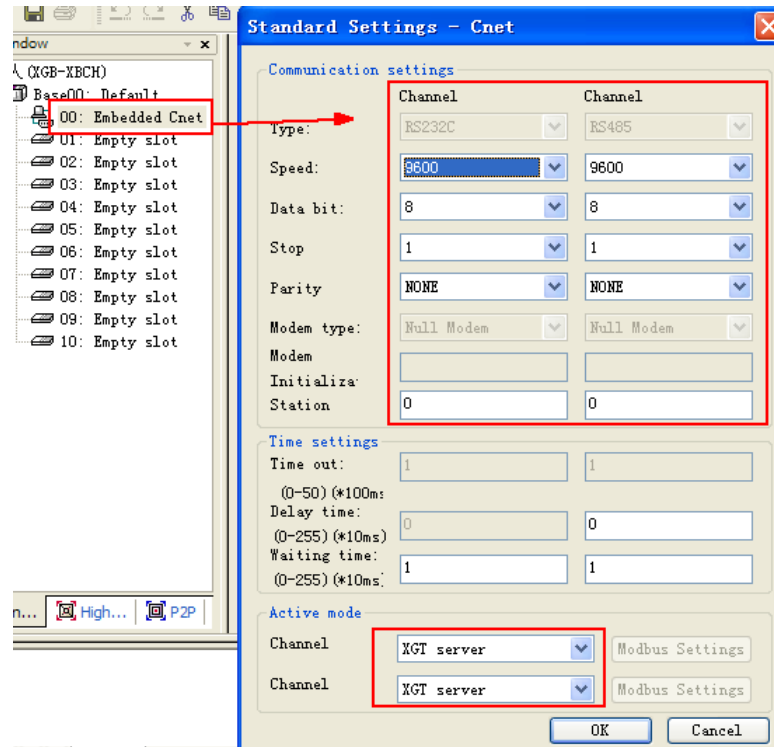

2. Communicating in the OPR mode

## LS XEC CPU Direct

### HMI Setting

Default communication parameters: 115200bps, 8, 1, none; PLC station No.:0

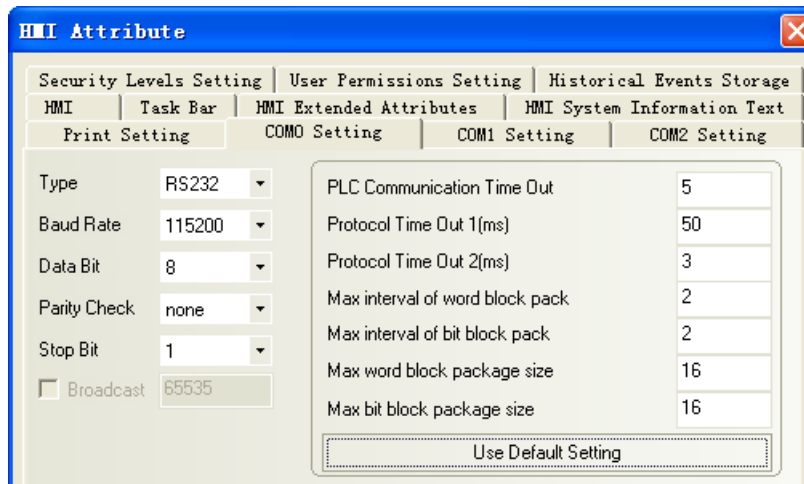

**NOTE:**Only support 115200 baud rate for the protocol; station number disable.

## LS XEC Cnet protocol

### HMI Setting

Default communication parameters: 9600bps, 8, 1, none; PLC station No.:0

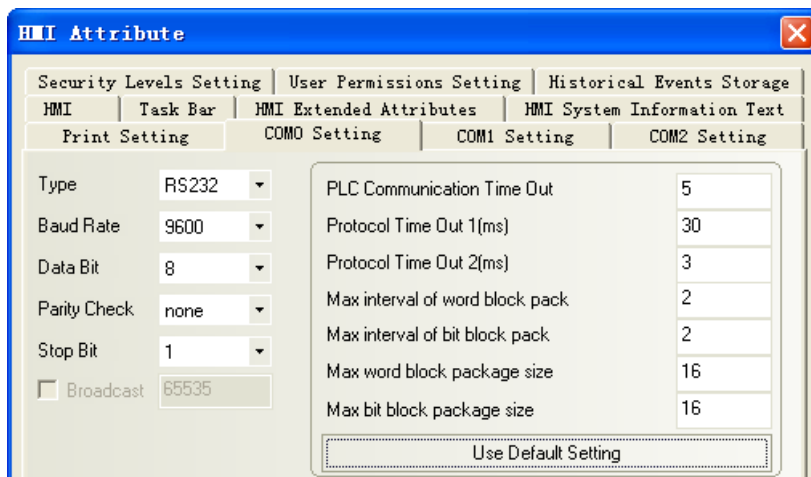

### PLC Setting

1. PLC parameter settings:[Tools]-[Network Manager].

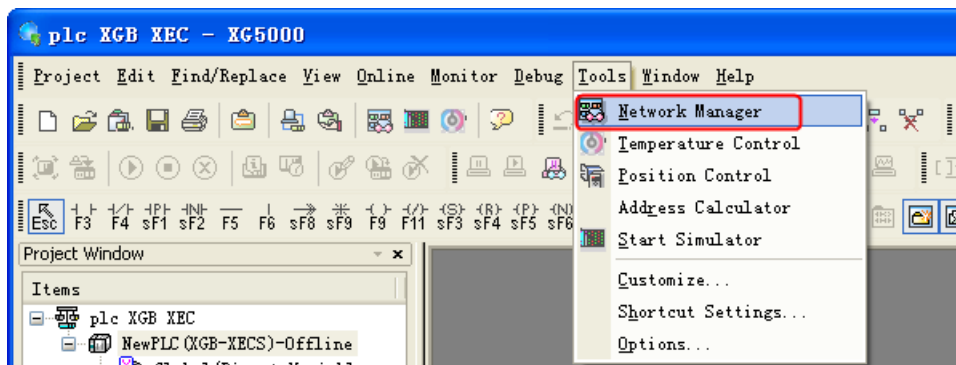

2. In the pop-up window “XG-PD”, create a new file, select the correct CPU kind.

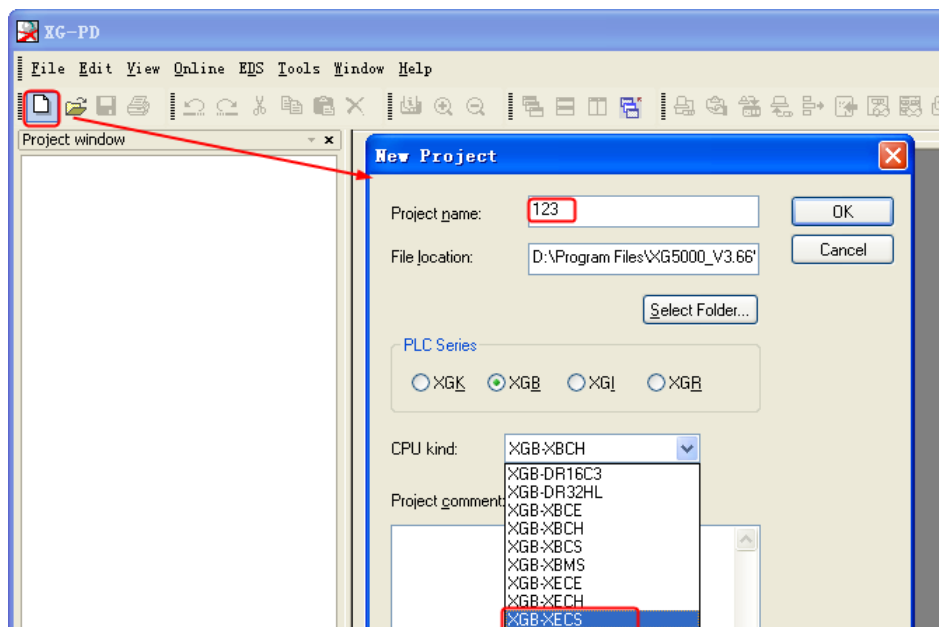

3. Double click the [ 00:Embedded Cnet], in the pop-up window “Standard Settings-Cnet” to set communication.

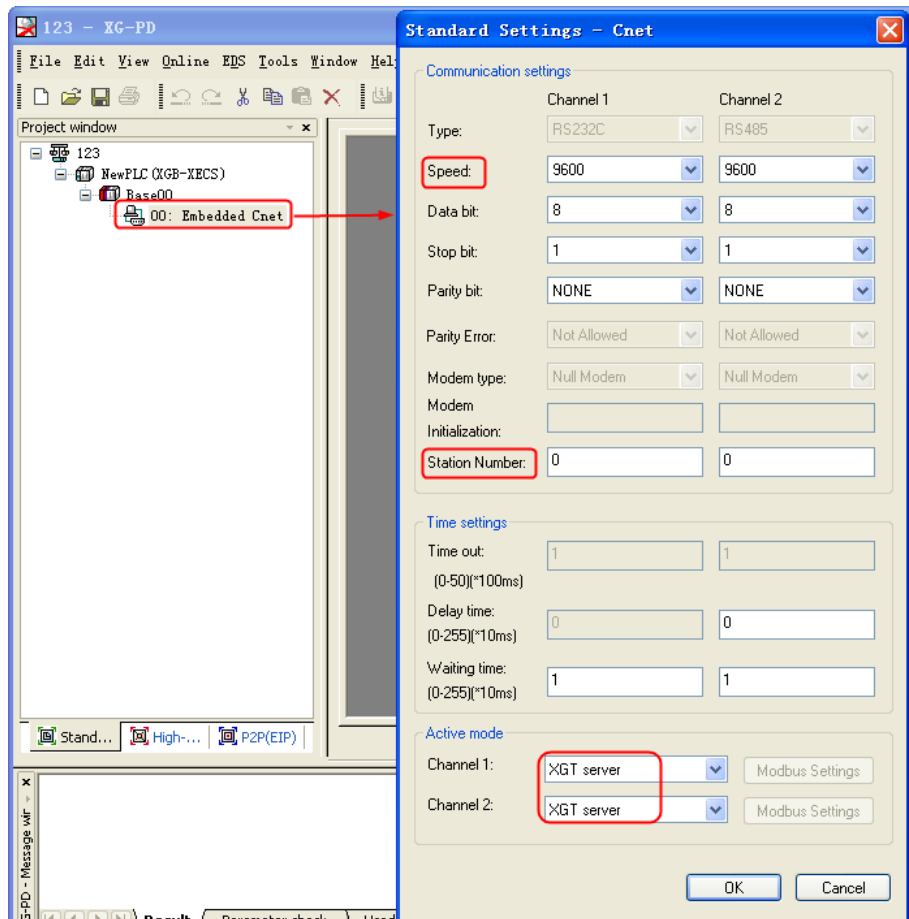

**LS GLOFA Cnet protocol**

Default communication: 9600, 8, none, 1; station: 0

**HMI Setting**

RS232 communication

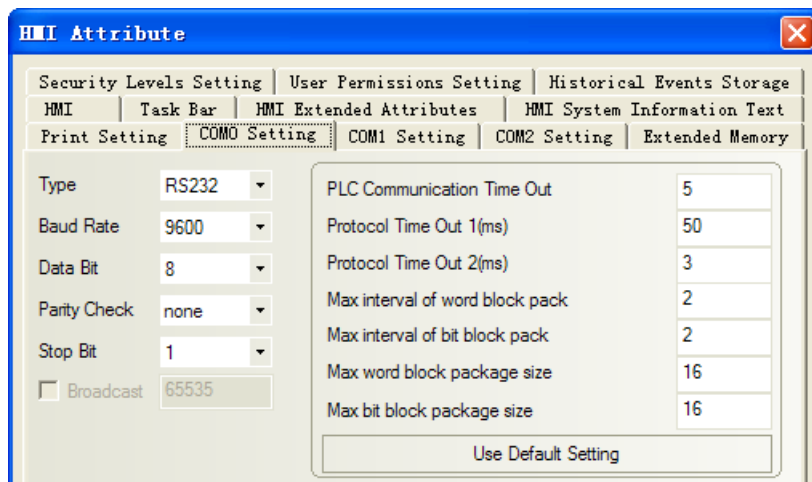

RS422 communication

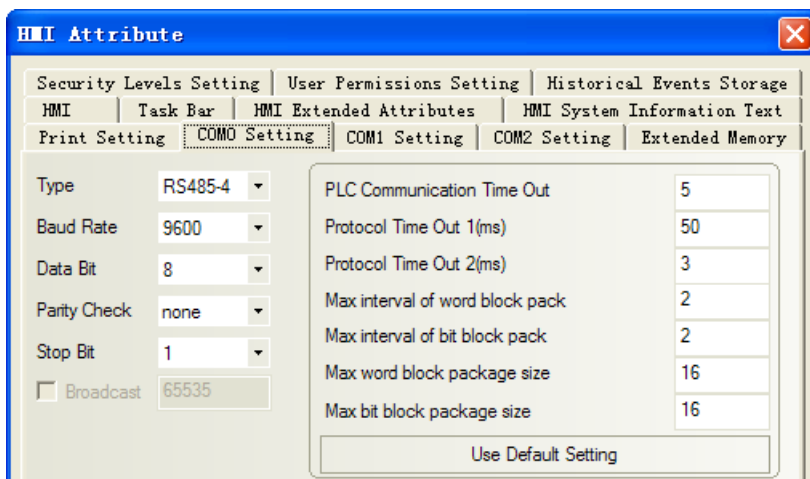

### PLC Setting

1. Set the parameters of CPU module

Open GMWIN, "Parameters" → "Basic Parameters" set "Communication":

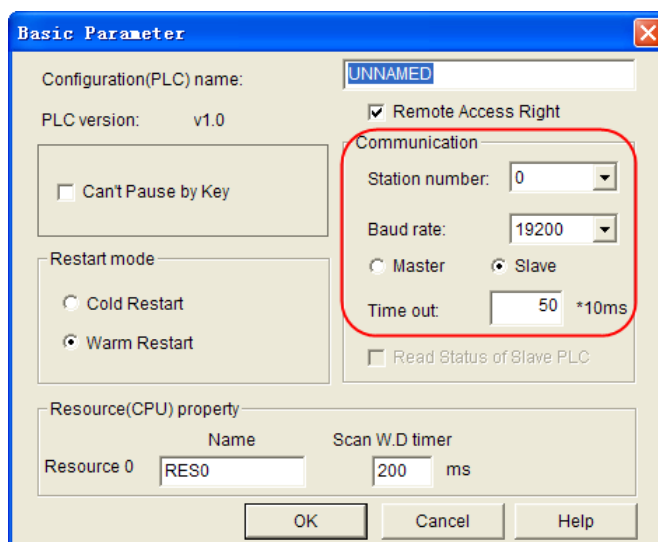

2. Set the parameters of module

Take G6L-CUEC for example,

Open GMWIN, select "Tool" → "Cnet Frame Editor",

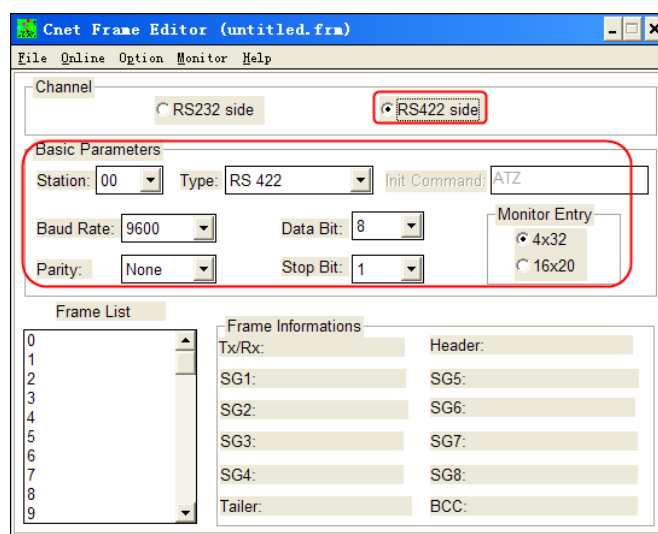

As G6L-CUEC is RS422/485 module, the channel should be selected “RS422 side”. After set the parameters, click “Online”→“Connect”, and then click “Online”→“Write” after the communication is built, pay attention to choose the correct Slot No..

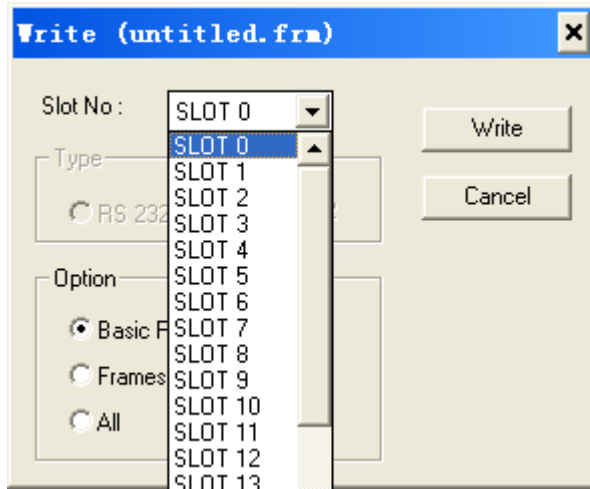

The Slot No. is the I/O slot position where the communication module is. For example, G6L-CUEC is plugged in the I/O 1, the Slot No. should be selected SLOT 1.

**NOTE:** Be sure to put the switch of the module to 9 (ON-LINE) position when communicating.

### LS ig5A Protocol

#### HMI Setting

Default communication: 9600bps, 8, none, 1; PLC station: 1

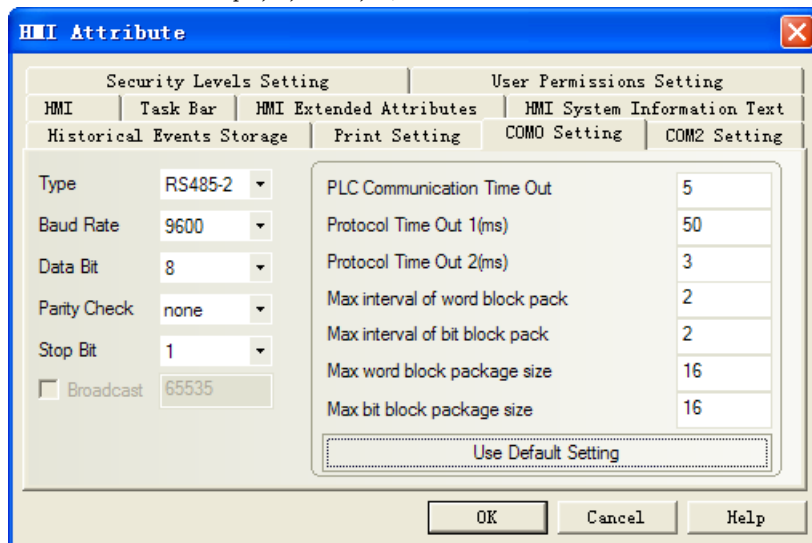

#### PLC Setting

Settings		Parameter	directions	
panel display	Addr			
I59	A43B	Protocol	0	Modbus RTU
			1	LS BUS
I60	A43C	Station	1-250	
I61	A43D	Baud Rate	0	1200[bps]
			1	2400[bps]
			2	4800[bps]

			3	9600[bps]
			4	19200[bps]
165	A441	Parity Check	0	none, stop bit:1
			1	none, stop bit:2
			2	even, stop bit:1
			3	odd, stop bit:1



The controller also supports the standard Modbus RTU protocol, set the agreement with LS ig5A.

### LS Ig5 Protocol

#### HMI Setting

Default communication: 9600bps, 8, none, 1; station: 1

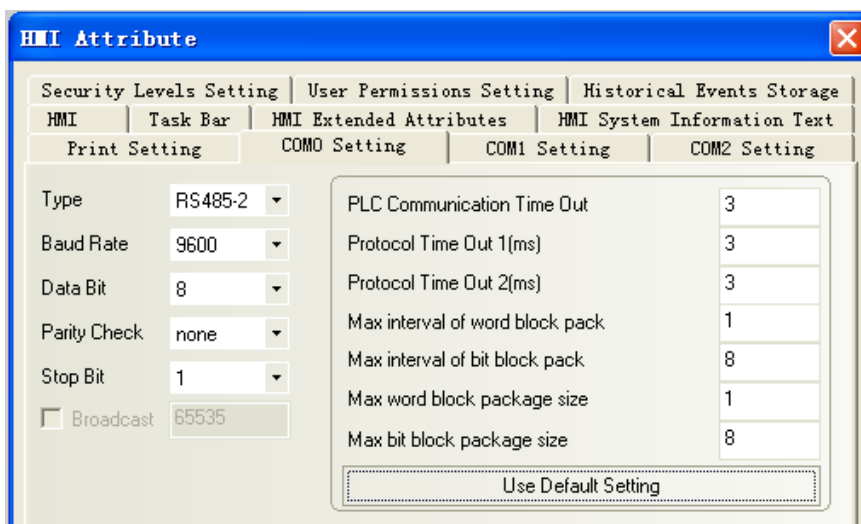

#### PLC Setting

Setting in operation panel:

Code	Name	Display	Range	Unit	Factory setting	Change
I/O-46	Inverter No.	I46	1 to 32	1	1	yes
I/O-47	Baud rate	I47	0: 1200bps 1: 2400bps 2: 4800bps 3: 9600bps 4: 19200bps	-	3: 9600bps	yes
I/O-50	Communication protocol	I50	0: LS-BUS 1-6: MODBUS ASCII 7-9: MODBUS-RTU		7	yes

Note: Setting communication protocol in operation panel(0: LS-BUS),when use inverter

### LS C100 Series Inverter Protocol

#### HMI Setting

Default communication:9600bps,8, non, 1; station: 1

(Attention, parity check : non , no modification)

## RS485

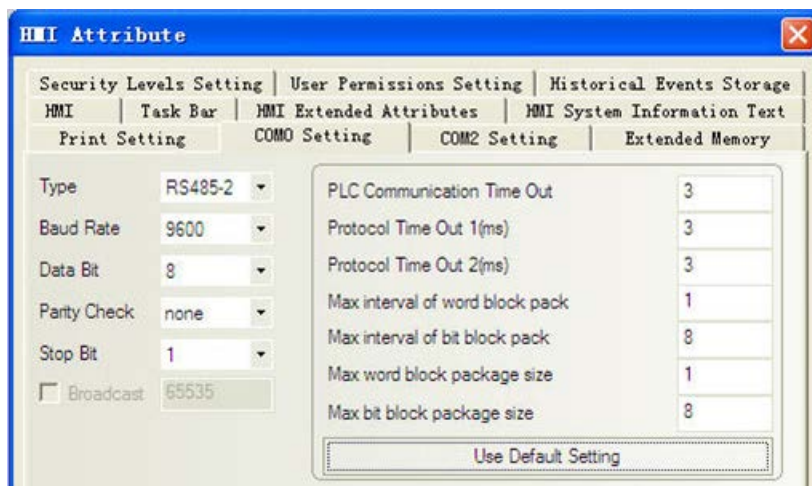

## ◎ Ethernet Communication Setting

### LS GLOFA FEnet protocol

#### GM6-CPU Setting

#### HMI Setting

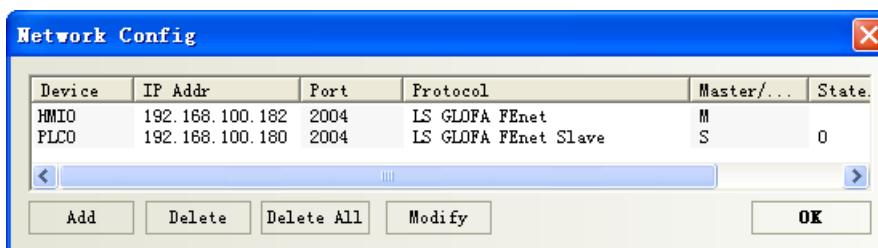
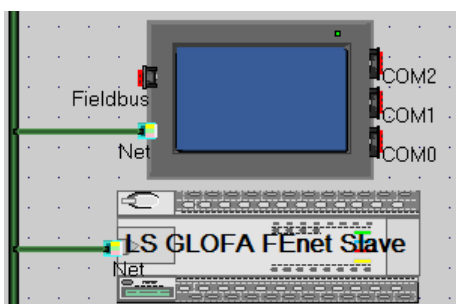

#### PLC Setting

1. Modify the parameters of PLC: "Tools" → "Enet Frame Editor", set the type as "FENET":



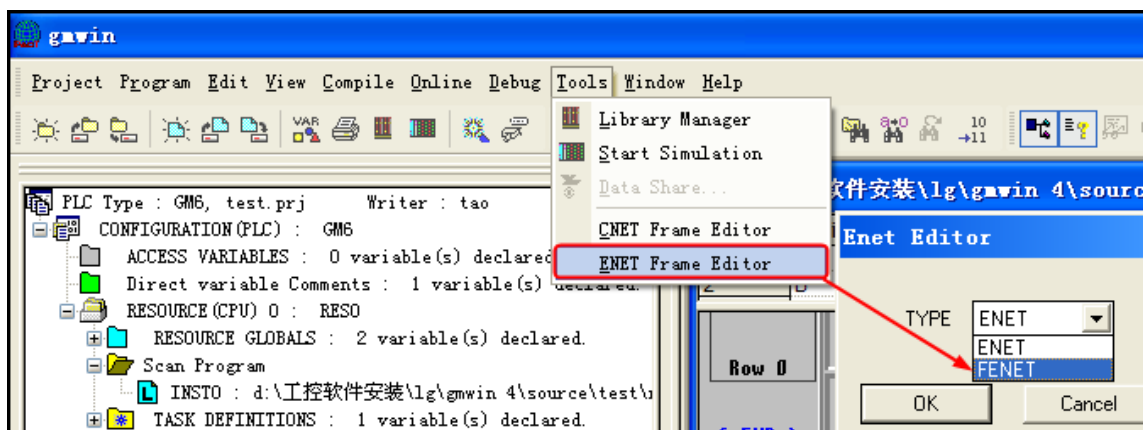

**NOTE:** Modify the IP address only via serial communication, and in the offline.

2. On the “Enet Editor” and select “Edit”, set the PLC series and IP address

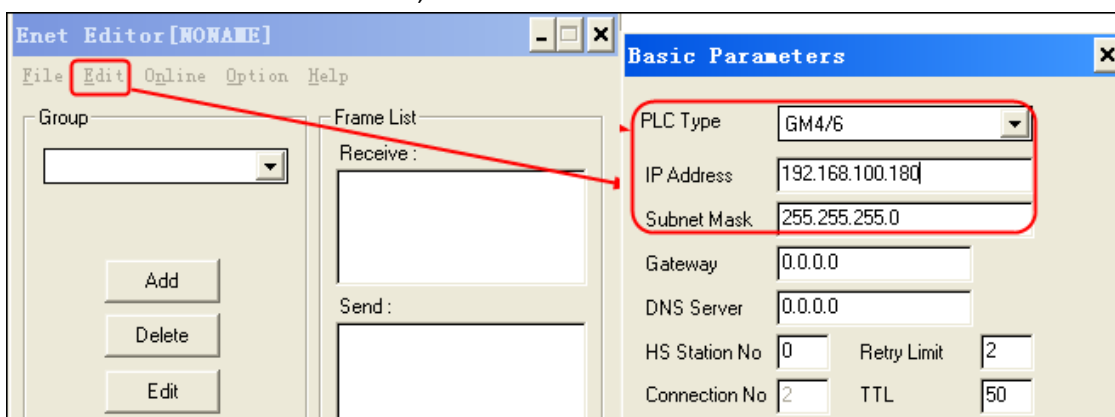

3. On the “Option” and select “COM Port”, set the serial port of PC

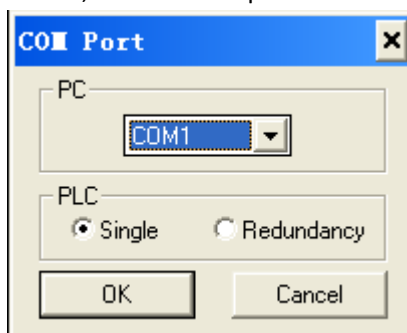

4. Download: “Online”→”Connect”→”Write”

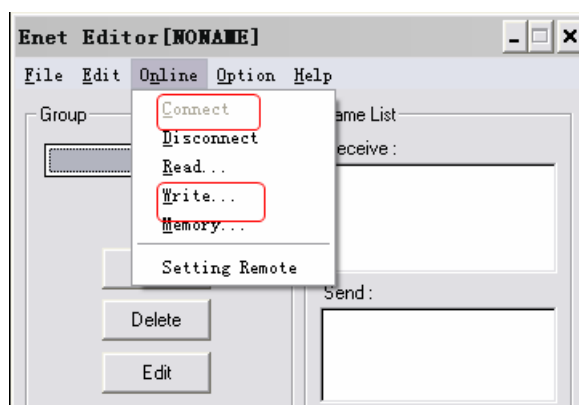

**XGK-CPUE Setting**

## HMI setting

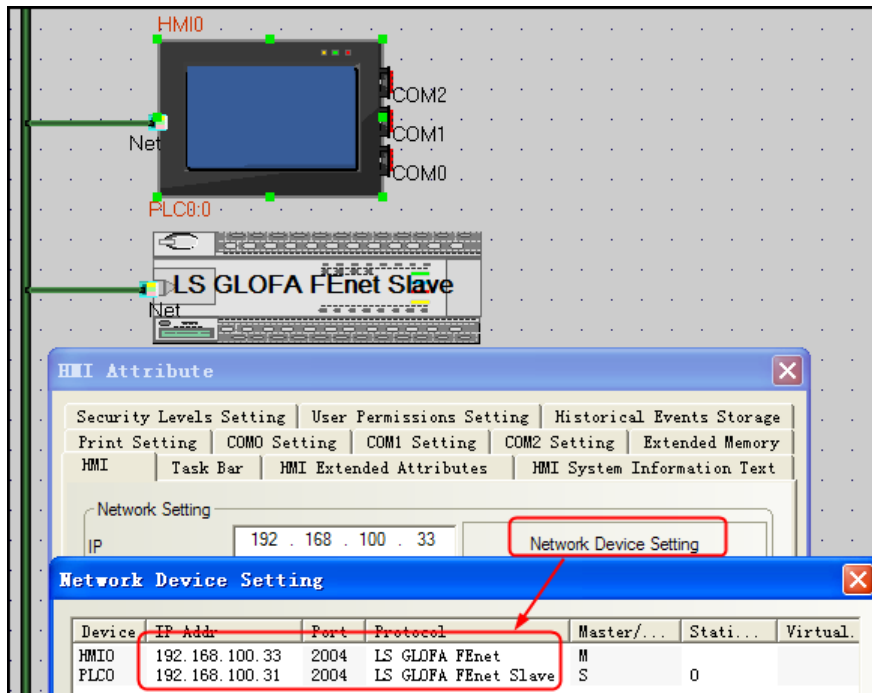

## PLC setting

1. PLC parameter settings: [Tools] - [network management], in the pop-up window XG-PD, create a new file, select the correct CPU kind.

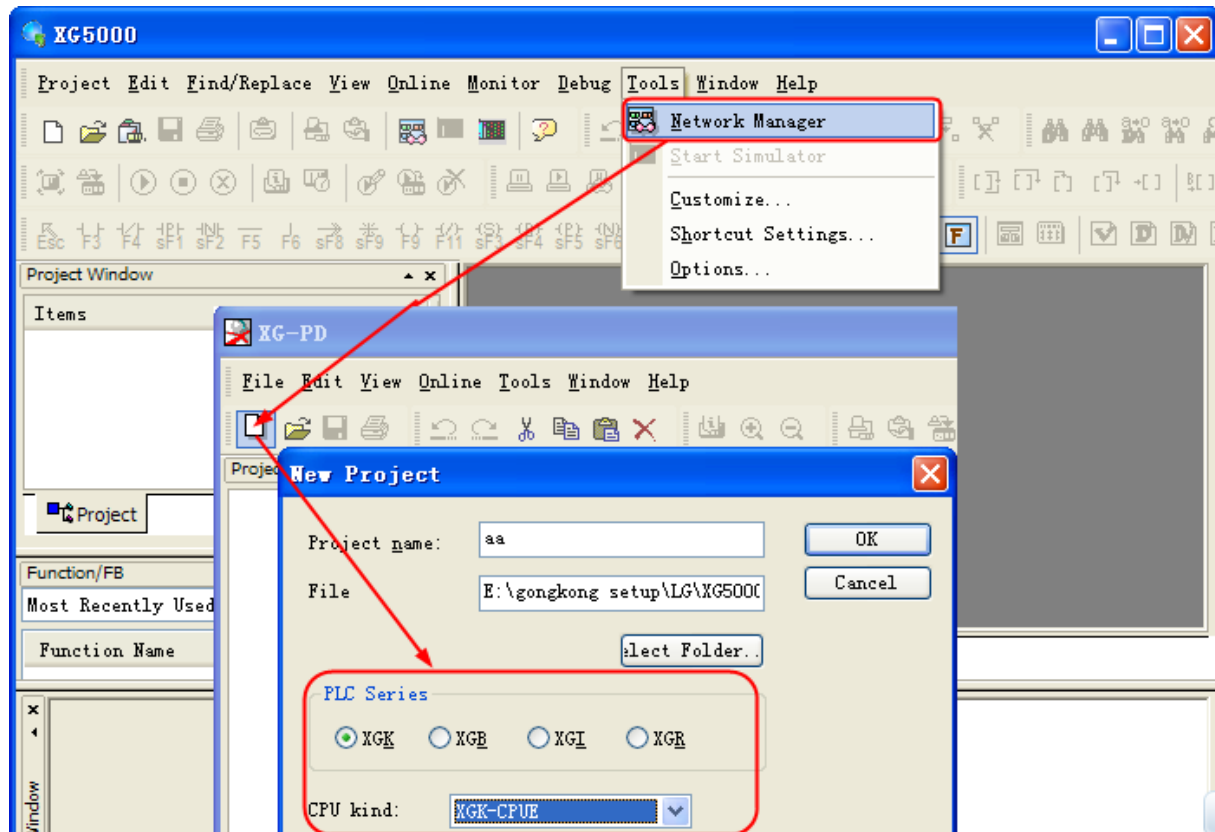

2. Double click the [ base 00 ], in the pop-up window [communication module Settings], select the category FEnet.

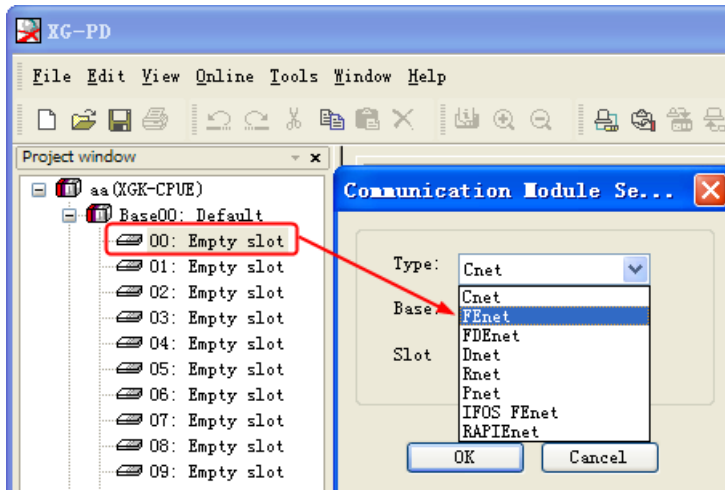

3. Double click the FENet, in the pop-up window [ Standard Settings] to set the IP address and drive .

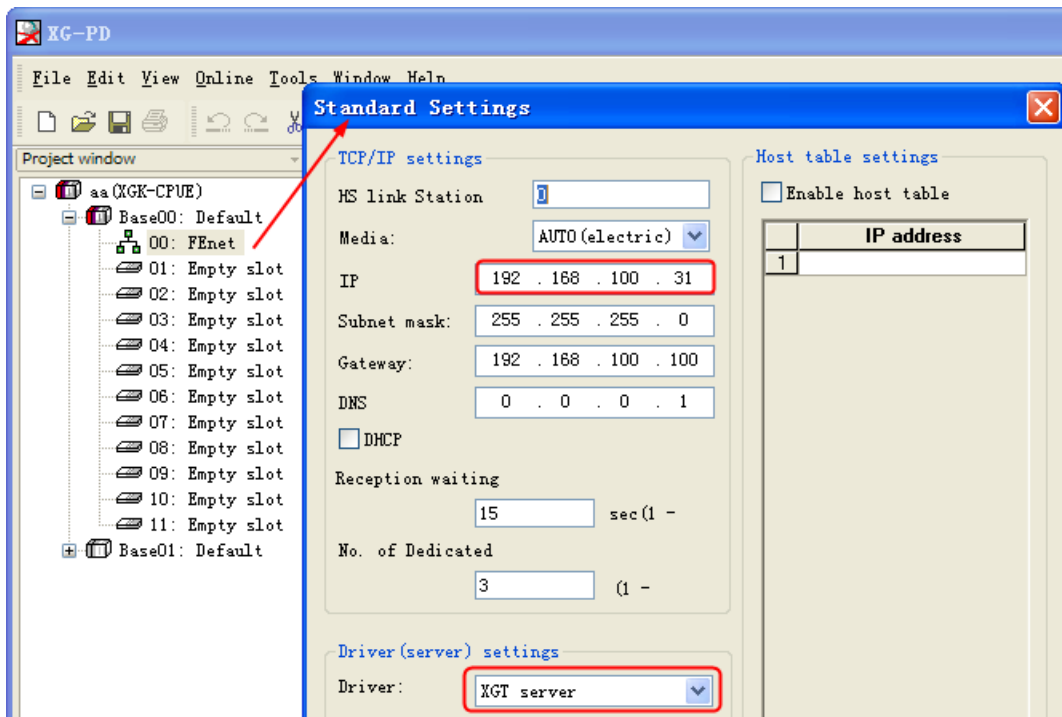

**LS XBC FENet Slave**  
**HMI Setting**

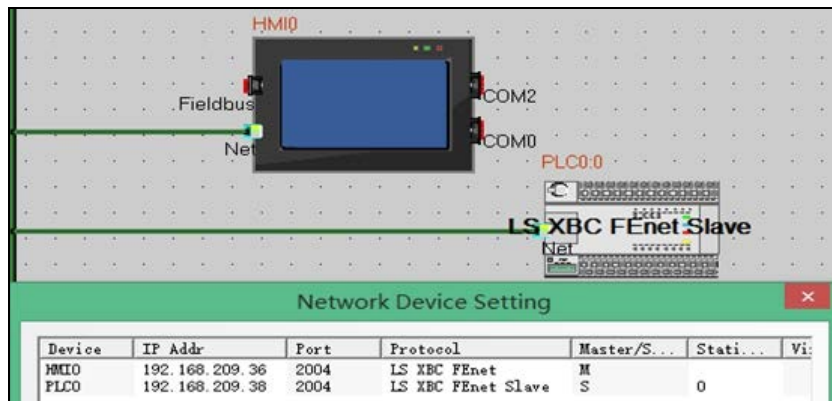

## PLC Setting

1. Open XG5000,new project aaa,choosing the right CPU ;

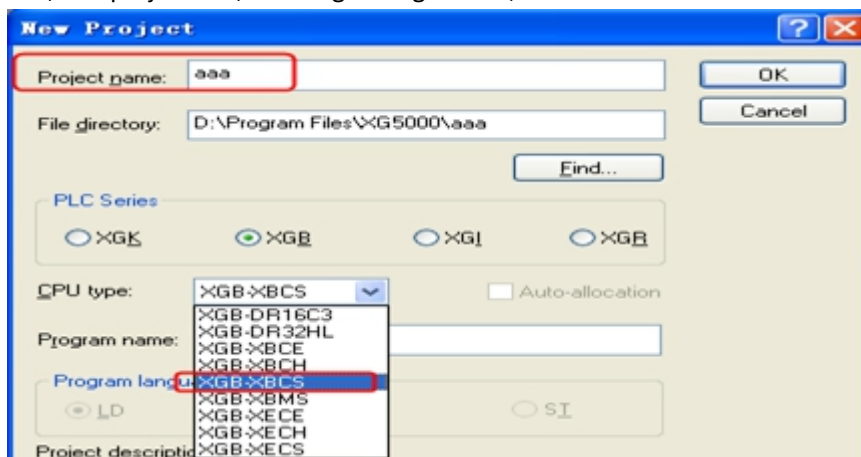

2. PLC parameter setting (IP setting) :

A. **【Tools】** → **【Network Manager】** ,new project bbb in XG-PD,choosing the right CPU;

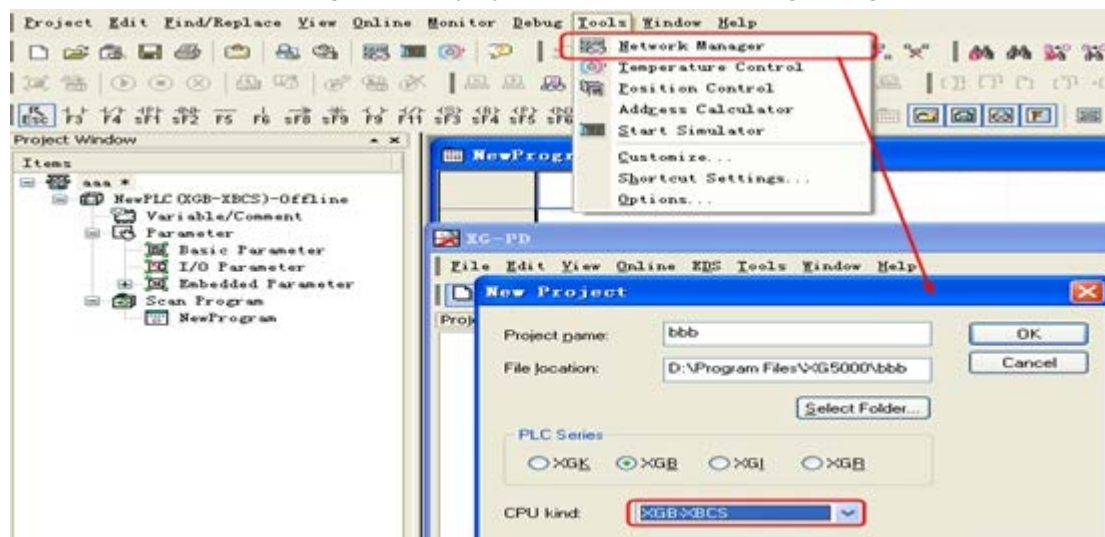

B. Right click **【Base00】** → **【Add Communication Module】** , Select FENet;

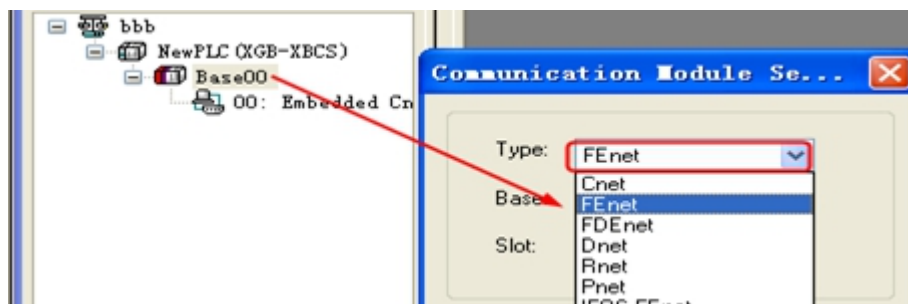

C. Setting IP and Driver in **【Standard Settings】** ;

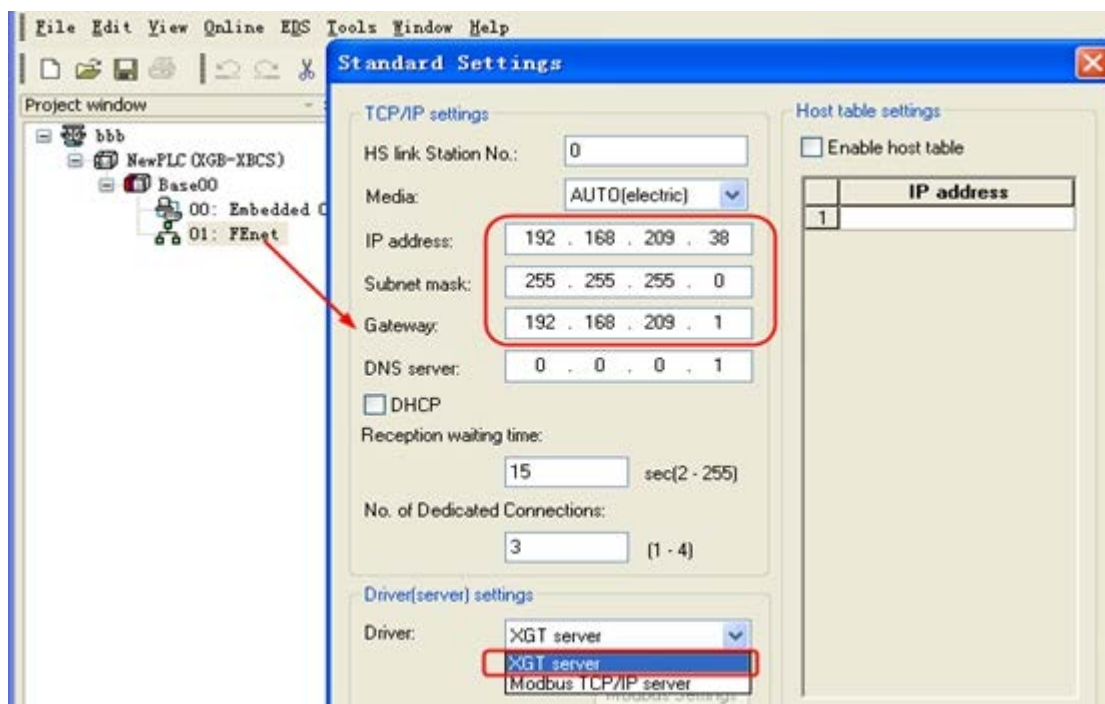

3. Setting OK, writer parameters to PLC;

### ☉ Supported Device

#### LS Master-K CPU Direct

Device	Bit Address	Word Address	Format	Notes
I/O Relay	P 0.0-256.0	-----	DDD.H	
Auxiliary Relay	M 0.0-256.0	-----	DDD.H	
Link Relay	L 0.0-256.0	-----	DDD.H	
Keep Relay	K 0.0-256.0	-----	DDD.H	
Special Relay	F 0.0-256.0	-----	DDD.H	
Counter	C 0-255	-----	DDD	
Timer	T 0-255	-----	DDD	
I/O Relay	-----	P 0-255	DDD	
Auxiliary Relay	-----	M 0-255		
Link Relay	-----	L 0-255		
Keep Relay	-----	K 0-255		
Special Relay	-----	F 0-255		
S	-----	S 0-255		
Timer	-----	T 0-4096	DDDD	
Counter	-----	C 0-4096	DDDD	
Data Register	-----	D 0-9999	DDDD	

**NOTE:** F address: 01 in the PLC corresponds to 0.1 in the HMI;  
 F address: 2A in the PLC corresponds to 2.A in the HMI.  
 Other register addresses, and so on.

**LS Master K-cnet**

Device	Bit Address	Word Address	Format	Notes
I/O Relay	P 0.0-256.0	-----	DDD.H	
Auxiliary Relay	M 0.0-256.0	-----	DDD.H	
Link Relay	L 0.0-256.0	-----	DDD.H	
Keep Relay	K 0.0-256.0	-----	DDD.H	
Special Relay	F 0.0-256.0		DDD.H	
Counter	C 0-255	-----	DDD	
Timer	T 0-255	-----	DDD	
Timer	-----	T 0-255	DDD	
Counter	-----	C 0-255	DDD	
Data Register		D 0-9999	DDDD	
I/O Relay	-----	P 0-255	DDD	
Auxiliary Relay	-----	M 0-255	DDD	
Link Relay	-----	L 0-255	DDD	
Keep Relay	-----	K 0-255	DDD	
Special Relay	-----	F 0-255	DDD	
S	-----	S 0-255	DDD	

**LS Modbus RTU**

Device	Bit Address	Word Address	Format	Notes
I/O Relay	P 0.0-1023.F	-----	DDD.H	
Auxiliary Relay	M 0.0-1023.F	-----	DDD.H	
Link Relay	L 0.0-2047.F	-----	DDD.H	
Keep Relay	K 0.0-4095.F	-----	DDD.H	
Special Relay	F 0.0-1023.F	-----	DDD.H	
Timer	-----	T 0-255	DDD	
Counter	-----	C 0-255	DDD	
Data Register	-----	D 0-9999	DDDD	

**LS XBC/XGK Cnet**

Device	Bit Address	Word Address	Format
	ZR_bit 0.0-65535.F		
	U_bit 0.0-4095.F		
File Relay	R_bit 0.0-32767.F		DDDDD.H
Data Relay	D_bit 0.0-32767.F		DDDDD.H
Communication Relay	N_bit 0.0-21503.F		DDDD.H
Link Relay	L_bit 0.0-11263.F		DDDD.H

	S_bit 0.0-127.F		
Index Relay	Z_bit 0.0-624.F	-----	DDD.H
Counter Contact Relay	C_bit 0-32767	-----	DDDD
Timer Contact Relay	T_bit 0-32767	-----	DDDD
Special Relay	F_bit 0.0-2047.F	-----	DDDD.H
Keep Relay	K_bit 0.0-8191.F	-----	DDDD.H
Auxiliary Relay	M_bit 0.0-2047.F	-----	DDDD.H
I/O Relay	P_bit 0.0-2047.F	-----	DDDD.H
		ZR 0-65535	
		U 0-4095	
File Register	-----	R 0-32767	DDDDD
Data Register	-----	D 0-32767	DDDDD
Communication Register	-----	N 0-21503	DDDD
Link Register	-----	L 0-11263	DDDD
Step Control Register		S 0-127	DDDD
Index Register		Z 0-9999	DDDD
Counter	-----	C 0-2047	DDDD
Timer	-----	T 0-2047	DDDD
Special Register	-----	F 0-2047	DDDD
Keep Register	-----	K 0-8191	DDDD
Auxiliary Register	-----	M 0-2047	DDDD
I/O Register	-----	P 0-2047	DDDD

NOTE: T\_bit、C\_bit are not supported to be transferred quantities

#### LS XBC/XGK CPU Direct

Device	Bit Address	Word Address	Format
	S_bit 0-127.F		
	U_bit 0-4095.F		
File Relay	R_bit 0.0-32767.F	-----	DDDDD.H
Data Relay	D_bit 0.0-32767.F	-----	DDDDD.H
Communication Relay	N_bit 0.0-21503.F	-----	DDDD.H
Link Relay	L_bit 0.0-11263.F	-----	DDDD.H
Index Relay	Z_bit 0.0-624.F	-----	DDD.H
	ZR_bit 0.0-65535.F	-----	DDDDD.H

Counter Contact Relay	C_bit 0-32767	-----	DDDD
Timer Contact Relay	T_bit 0-32767	-----	DDDD
Special Relay	F_bit 0.0-2047.F	-----	DDDD.H
Keep Relay	K_bit 0.0-4095.F	-----	DDDD.H
Auxiliary Relay	M_bit 0.0-2047.F	-----	DDDD.H
I/O Relay	P_bit 0.0-2047.F	-----	DDDD.H
		U 0-4095	
File Register	-----	R 0-32767	DDDDD
Data Register	-----	D 0-32767	DDDDD
Communication Register	-----	N 0-21503	DDDD
Link Register	-----	L 0-11263	DDDD
Step Control Register	-----	S 0-127	DDDD
Index Register	-----	Z 0-9999	DDDD
	-----	ZR 0-65535	DDDDD
Counter Set Value	-----	C_SV 0-2047	DDDD
Timer Set Value	-----	T_SV 0-2047	DDDD
Counter Current Value	-----	C_CV 0-9999	DDDD
Timer Current Value	-----	T_CV 0-9999	DDDD
Special Register	-----	F 0-2047	DDDD
Keep Register	-----	K 0-4095	DDDD
Auxiliary Register	-----	M 0-2047	DDDD
I/O Register	-----	P 0-2047	DDDD

#### LS XEC CPU Direct

Device	Bit Address	Word Address	Format	
	A_Bit 0-262143	-----	DDDDDD	
Special Relay	F_Bit 0-16383	-----	DDDDD	
	W_Bit 0-163839	-----	DDDDDD	Same area with R
File Relay	R_Bit 0-163839	-----	DDDDDD	
Communication Relay	N_Bit 0-81919	-----	DDDDD	
Special module Relay	U_Bit 0-8191	-----	DDDD	
Keep Relay	K_Bit 0-65535	-----	DDDDD	
Link Relay	L_Bit 0-32767	-----	DDDDD	
Auxiliary Relay	M_Bit 0-131071	-----	DDDDDD	
Output Relay	Q_Bit 0-16383	-----	DDDDD	
Input Relay	I_Bit 0-16383	-----	DDDDD	
	-----	A 0-16383	DDDDD	
Special Register	-----	F 0-1023	DDDD	
	-----	W 0-10239	DDDDD	



File Register	-----	R 0-10239	DDDDD	
Communication Register	-----	N 0-5119	DDDD	
Special module Register	-----	U 0-511	DDD	
Keep Register	-----	K 0-4095	DDDD	
Link Register	-----	L 0-2047	DDDD	
Auxiliary Register	-----	M 0-8191	DDDD	
Output Register	-----	Q 0-1023	DDDD	
Input Register	-----	I 0-1023	DDDD	

### LS XEC Cnet

Device	Bit Address	Word Address	Format	
	A_Bit 0-524287	-----	DDDDDD	
Special Relay	F_Bit 0-32767	-----	DDDDD	
	W_Bit 0-524287	-----	DDDDDD	Same area with R
File Relay	R_Bit 0-262143	-----	DDDDDD	
Special module Relay	U_Bit 0-15511	-----	DDDDD	
Keep Relay	K_Bit 0-131071	-----	DDDDD	
Link Relay	L_Bit 0-65535	-----	DDDDD	
Auxiliary Relay	M_Bit 0-262143	-----	DDDDDD	
Communication Relay	N_Bit 0-163839	-----	DDDDD	
Output Relay	Q_Bit 0-151563	-----	DDDDDD	
Input Relay	I_Bit 0-151563	-----	DDDDDD	
	-----	A 0-32767	DDDDD	
Special Register	-----	F 0-2047	DDDD	
	-----	W 0-32767	DDDDD	
File Register	-----	R 0-16383	DDDDDD	
Special module Register	-----	U 0-1531	DDDD	
Keep Register	-----	K 0-8191	DDDD	
Communication Register	-----	N 0-10239	DDDD	
Link Register	-----	L 0-4095	DDDD	
Auxiliary Register	-----	M 0-16383	DDDD	
Output Register	-----	Q 0-15153	DDDDDD	
Input Register	-----	I 0-15153	DDDDDD	



1. The address format of %UX is D.DD.DDD (0.0.0-0.15.511) in the PLC, it correspond to DDDDD (0-15511) in the HMI. And the %UX 0.m.n in the PLC is U\_Bit  $m*512+n$  in the HMI.

**For example,**

Internal address: %UX 0.1.0 in the PLC correspond to U\_Bit 512 in the HMI

Internal address: %UX 0.15.511 in the PLC correspond to U\_Bit 8191 in the HMI

Similarly, the %UW 0.0.0-0.15.511 in the PLC correspond to U\_Word 0-1531 in the HMI. The %UW 0.m.n in the PLC is U\_Word  $m*32+n$ .

**For example,**

Internal address: %UW 0.1.0 in the PLC correspond to U\_Word 32 in the HMI

Internal address: %UW 0.15.31 in the PLC correspond to U\_Word 511 in the HMI

2. The address format of %QX/IX is DD.DD.DD (0.0.0-15.15.63) in the PLC, it correspond to DDDDDD (0-151563) in the HMI. And the %QX/IX a.b.c in the PLC is Q\_Bit/I\_Bit  $a*1024+b*64+c$  in the HMI.

**For example,**

Internal address: %QX/IX 0.1.0 in the PLC correspond to Q\_Bit/I\_Bit 64 in the HMI

Internal address: %QX/IX 15.15.63 in the PLC correspond to Q\_Bit/I\_Bit 16383 in the HMI

Similarly, the %QW/IW 0.0.0-15.15.3 in the PLC correspond to Q\_Word/I\_Word 0-15153 in the HMI. The %QW/IW a.b.c in the PLC is Q\_Word/I\_Word  $a*64+b*4+c$ .

**For example,**

Internal address: %QW/IW 0.1.0 in the PLC correspond to Q\_Word/I\_Word 4 in the HMI

Internal address: %QW/IW 15.15.63 in the PLC correspond to Q\_Word/I\_Word 1023 in the HMI

#### LS GLOFA Cnet

Device	Bit Address	Word Address	Format	Notes
Buffer Memory(Bit)	MX0-32767	-----	DDDDDD	
Output(Bit)	QX0-1763	-----	DDDD	
Input(Bit)	IX0-1763	-----	DDDD	
Buffer Memory(Dword)	-----	MD0-16368	DDDDDD	
Output(Dword)	-----	QD0.0-17.1	DD.D	
Input(Dword)	-----	ID0.0-17.1	DD.D	
Buffer Memory(Word)	-----	MW0-32767	DDDDDD	
Output(Word)	-----	QW0.0-17.3	DD.D	
Input(Word)	-----	IW0.0-17.3	DD.D	

#### LS GLOFA FEnet

Device	Bit Address	Word Address	Format	Notes
Buffer Memory(Bit)	MX0-131056	-----	DDDDDD	
Output(Bit)	QX0-1763	-----	DDDD	
Input(Bit)	IX0-1763	-----	DDDD	
Buffer Memory(Dword)	-----	MD0-4095	DDDD	
Output(Dword)	-----	QD0.0-17.1	DD.D	
Input(Dword)	-----	ID0.0-17.1	DD.D	
Buffer Memory(Word)	-----	MW0-8191	DDDD	
Output(Word)	-----	QW0.0-17.3	DD.D	

Input(Word)	-----	IW0.0-17.3	DD.D	
-------------	-------	------------	------	--

**NOTE:**

1. The address format of %QX\IX is DD.D.DD (00.0.00~63.7.63) in the PLC, it correspond to DD D DD (0~63763) in the HMI; Note that put 0 before the address if the address is less than two bits.

**For example,**

Internal address : %QX\IX **0.3.1** in the PLC correspond to QX\IX **301** in the HMI;

Internal address : %QX\IX **1.4.63** in the PLC correspond to QX\IX **1463** in the HMI;

2. The address format of %QD\ID is D.D.D (0.0.0~1.7.1) in the PLC, it correspond to D D.D (0.0~17.1) in the HMI;

**For example,**

Internal address : %QD\ID **0.3.1** in the PLC correspond to QD\ID **3.1** in the HMI;

Internal address : %QD\ID **1.5.1** in the PLC correspond to QD\ID **15.1** in the HMI;

3. The address format of %QW\IW is D.D.D (0.0.0~1.7.3) in the PLC, it correspond to D D.D (0.0~17.3) in the HMI;

**For example,**

Internal address : %QW\IW **0.3.1** in the PLC correspond to QW\IW **3.1** in the HMI;

Internal address : %QW\IW **1.5.3** in the PLC correspond to QW\IW **15.3** in the HMI;

**LS iG5A protocol**

Device	Bit Address	Word Address	Format
Bits	AB 0.0-65535.F	-----	DDDDD
Words	-----	AW 0-65535	DDDDD

- 1、The representation of address is hexadecimal in the Inverter User's Manual , used in the project must be converted to decimal.Such as universal domain address 0000 corresponds to AW0, The address of the function list A100 corresponds AW41216.

**NOTE:**

- 2、Register more than eight consecutive addresses will not be properly read.
- 3、Some address may affect the surrounding register read, should used separately:  
H8 and H10, H42 and H44,do not show put together  
H20, H30, H36, H37, H42, H50, H51, H52, H70, H90  
F30, F37, F60, I27, I57

**MODBUS RTU protocol (support LS iG5A)**

Device	Bit Address	Word Address	Format
Read Holding Registers	-----	3X 1-65535	DDDDD
Read Input Registers	-----	4X 1-65535	DDDDD

Inverter address converted to decimal, the address of the function list A100 corresponds AW41216.

**NOTE:**

Modbus address starting from 1, the general field of 0000 address is inaccessible.

**LS C100 Series Inverter protocol**

Device	Bit Address	Word Address	Format	Notes
--------	-------------	--------------	--------	-------

Driver	-----	Fbr 0	D	
	-----	rEF 0	D	
	-----	Fra 0	D	
	-----	drv2 0	D	
	-----	drC 0	D	
	-----	nOn 0	D	
	-----	vOL 0	D	
	-----	dCL 0	D	
	-----	rPM 0	D	
	-----	CUr 0	D	
	-----	St3 0	D	
	-----	St2 0	D	
	-----	St1 0	D	
	-----	Frq 0	D	
	-----	drv 0	D	
	-----	dEC 0	D	
	-----	ACC 0	D	
	-----	DRIVER_0 0	D	
I/O	-----	I 0-87	DD	
Funcation 1	-----	F0-72	DD	
Funcation 2	-----	H0-95	DD	

### LS XBC FEnet Slave protocol

Device	Bit Address	Word Address	Format	Notes
I/O Relay	P_Bit 0.0-2047.F	-----	DDDD.H	
Link Relay	L_Bit 0.0-11263.F	-----	DDDDD.H	
Counter Contact Relay	C_Bit 0-2047	-----	DDDD	
Timer Contact Relay	T_Bit 0-2047	-----	DDDD	
Special Relay	F_Bit 0.0-2047.F	-----	DDDD.H	
Keep Relay	K_Bit 0.0-4095.F	-----	DDDD.H	
Auxiliary Relay	M_Bit 0-8191.F	-----	DDDD.H	
Analog Data	-----	U_Word 0.00-127.31	DDD.DD	
	-----	ZR_Word 0-65535	DDDDD	
File Register	-----	R_Word 0-32767	DDDDD	
Data Register	-----	D_Word 0-32767	DDDDD	
Communication Register	-----	N_Word 0-21503	DDDDD	
Counter Register	-----	C_Word 0-2047	DDDD	

Timer Register	-----	T_Word 0-2047	DDDD	
Link Register	-----	L_Word 0-11263	DDDDD	
Step Control Register	-----	S_Word 0-127	DDD	
Index Register	-----	Z_Word 0-127	DDD	
Special Register	-----	F_Word 0-2047	DDDD	
Keep Register	-----	K_Word 0-4095	DDDD	
Auxiliary Register	-----	M_Word 0-2047	DDDD	
I/O Register	-----	P_Word 0-2047	DDDD	

### ◎ Cable Diagram

#### LS Master-K Cnet/ LS Master-K Modbus RTU protocol

##### RS232 communication cable

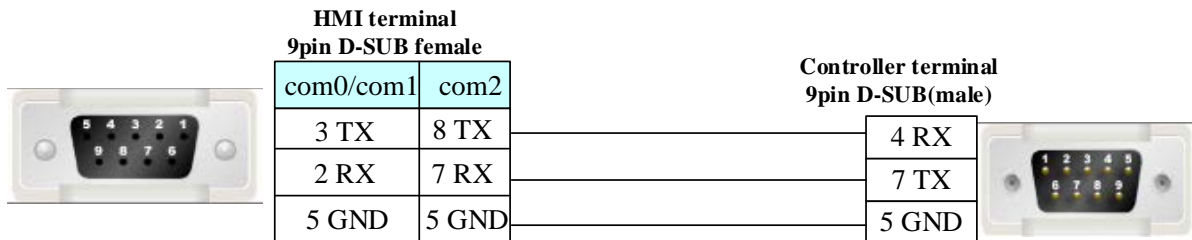

##### RS485 communication cable

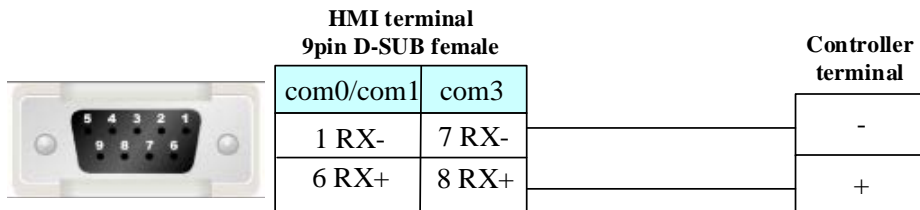

#### LS Master-K CPU Direct protocol

##### RS232 communication cable

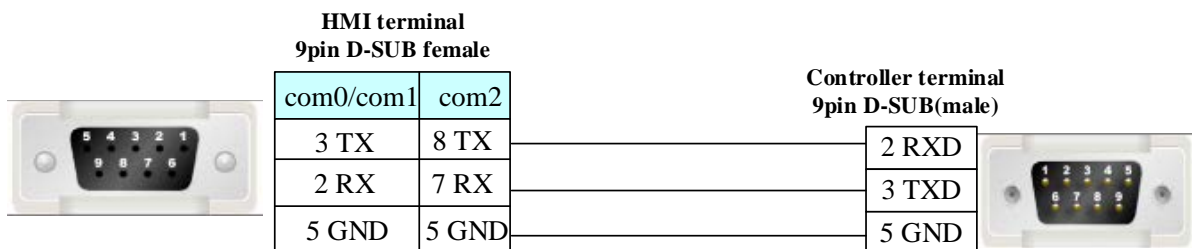

#### LS XBC/XGK/XEC CPU Direct protocol

##### RS232 communication cable

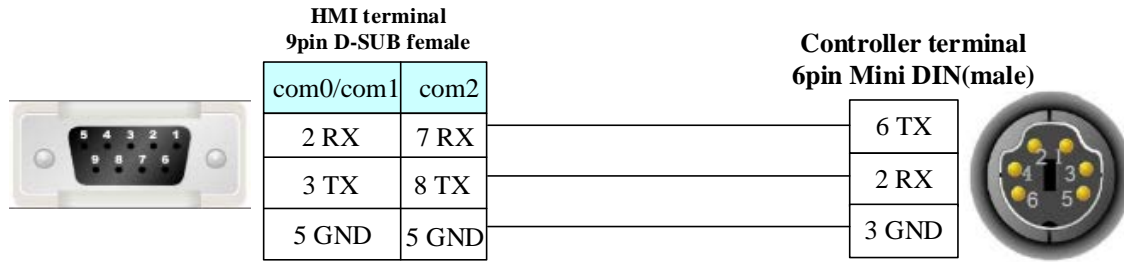

**LS XBC/XGK/XEC Cnet protocol**

**RS232 programming cable**

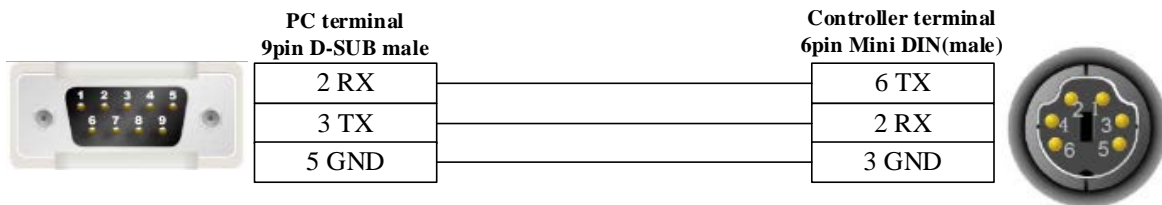

**RS232 communication cable**

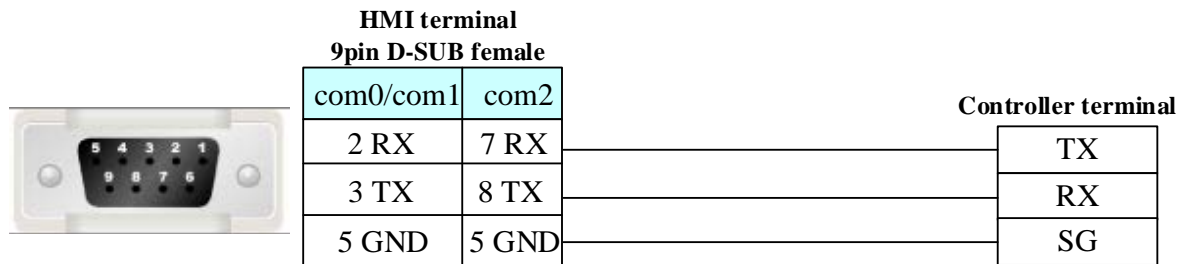

**RS485 communication cable**

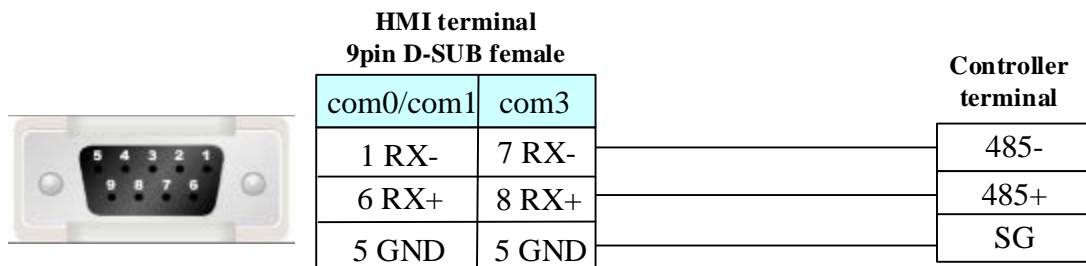

**LS GLOFA Cnet protocol**

**RS232 communication cable**

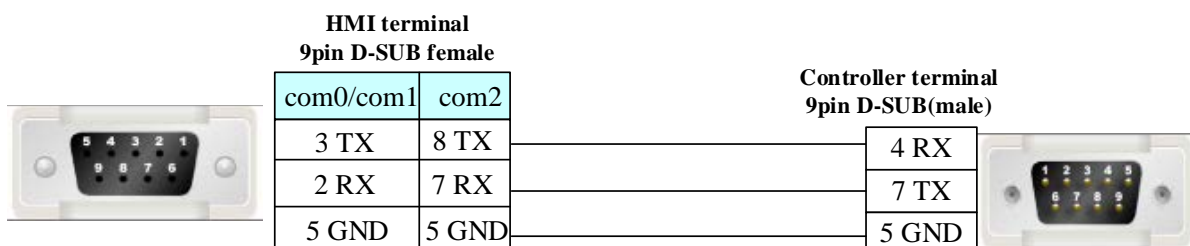

### RS422 communication cable

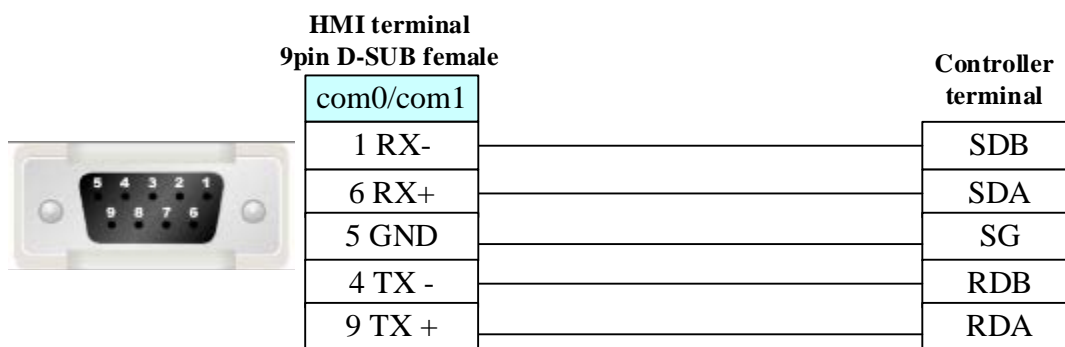

**NOTE:** Be sure to put the switch of the module to 9 (ON-LINE) position when communicating.

### LS iG5A protocol

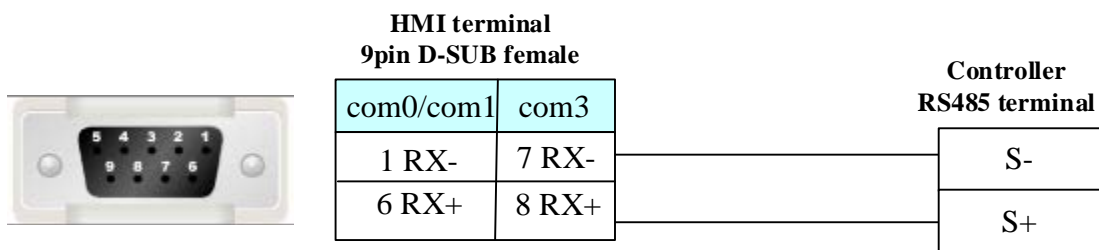

### Ethernet Cable

Cross-connection or crossover network cable can be used as communication cable via the hub  
Refer to [3.3 Download by Network Ethernet](#) for method of making connection cable.

### LS C100 Series Inverter protocol

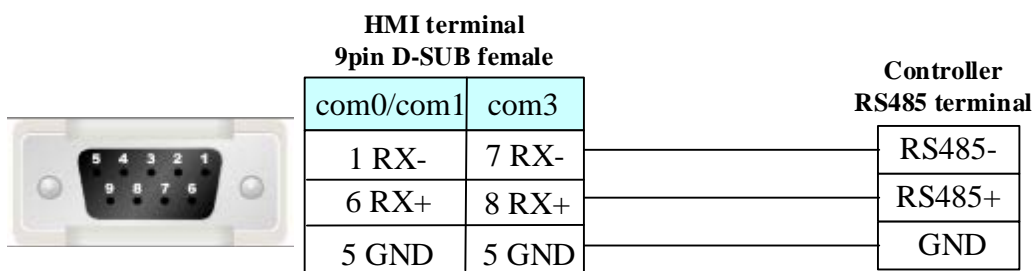

## 4.49 LUST

### ◎ Serial Communication

Series	CPU	Link Module	Driver
CDE34.008	CDE34.008	RS232 on the CPU unit	LustBus

### ◎ Network communication (direct online simulation disable)

Series	CPU	Link Module	Driver

ServoOne junior	Lust	ETH on the CPU	Lust Ethernet Slave
-----------------	------	----------------	---------------------

◎ **Serial System configuration**

Series	CPU	Link Module	COM Type	Parameter	Cable
CDE34.008	CDE34.008	RS232 on the CPU unit	RS232	<a href="#">Setting</a>	<a href="#">Your owner cable</a>

◎ **Network System configuration**

Series	CPU	Link Module	COMM Type	Parameter	Cable
ServoOne junior	Lust	ETH on the CPU	ETH	<a href="#">Setting</a>	<a href="#">Your owner cable</a>

◎ **Serial Communication Setting**

Lustbus RS232 default communication: 57600, 7, even, 1; station: 1

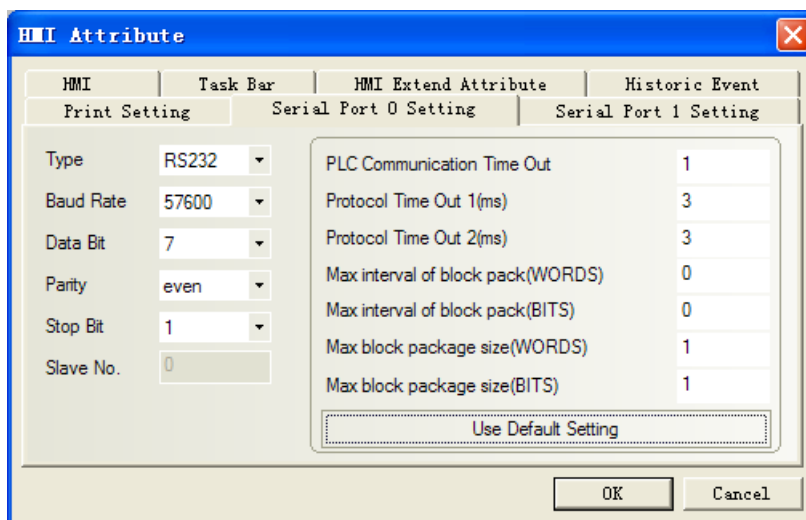

◎ **Network Communication Setting**

HMI Setting

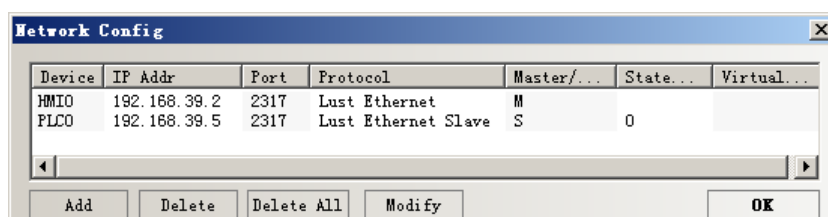
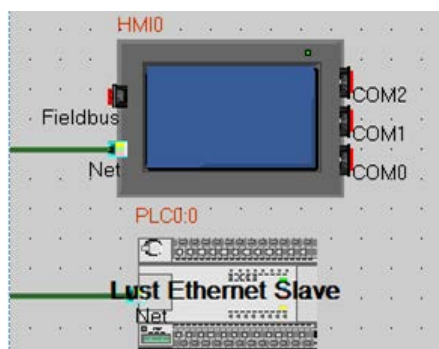

The way to change IP of Servo drive system



Plug the 24-volt power supply on the X2, plug the network cable on the X9.

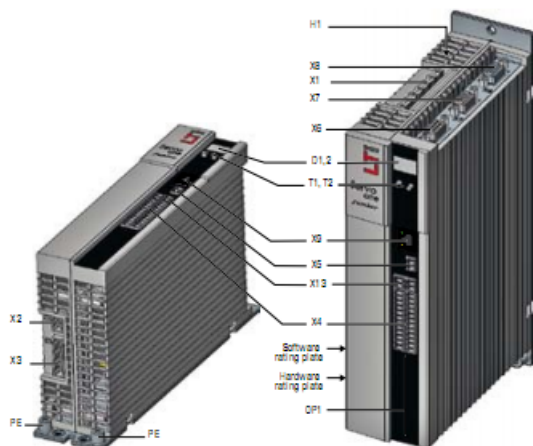

Figure 3.1 Layout

No.	Designation	No.	Designation
D1, D2	7-segment display	X4	Control terminals
H1	DC link voltage indicator LED	X5	Motor temperature monitoring
OP1	Installation space for option 1 (Communication)	X6	Resolver connection
PE	Protective conductor connection	X7	Connection for high-resolution encoders
T1, T2	Button	X8	Option 2 - Technology
X1	Power connection	X9	Ethernet port
X2	Connection of control supply $U_v$	X13	Connection of motor brake
X3	AC mains connection		



Figure 4.1 Integrated operator control unit

Refer to the map, press the T1 or T2 to modify the IP

Menu level	Parameter	Value range	Meaning	Explanation	
IP	lu	b0	00..FF	IP address update Byte 0	Setting of byte 0 of the IP address in hexadecimal format (e.g. "05" for 192.168.39.5)
		b1	00..FF	IP address update Byte 1	Setting of byte 1 of the IP address in hexadecimal format (e.g. "27" for 192.168.39.5)
		b2	00..FF	IP address update Byte 2	Setting of byte 2 of the IP address in hexadecimal format (e.g. "A8" for 192.168.39.5)
		b3	00..FF	IP address update Byte 3	Setting of byte 3 of the IP address in hexadecimal format (e.g. "C0" for 192.168.39.5)
	lr	-	-	IP reset to factory setting	Reset IP address to factory default (192.168.39.5)
Su	b0	b0	00..FF	Subnetmask update Byte 0	Setting of byte 0 of the subnet mask in hexadecimal format (e.g. "00" for 255.255.255.0)
		b1	00..FF	Subnetmask update Byte 1	Setting of byte 1 of the subnet mask in hexadecimal format (e.g. "FF" for 255.255.255.0)
		b2	00..FF	Subnetmask update Byte 2	Setting of byte 2 of the subnet mask in hexadecimal format (e.g. "FF" for 255.255.255.0)
		b3	00..FF	Subnetmask update Byte 3	Setting of byte 3 of the subnet mask in hexadecimal format (e.g. "FF" for 255.255.255.0)
	Sr	-	-	Subnetmask reset to factory setting	Reset subnet mask to factory default setting (255.255.255.0)
	Po	-	0..3 or --	Transmit power	Setting of fibre-optic power output (only with SERCOS II option), otherwise display "--"

Table 4.12 IP address menu

Parameter		b3	b2	b1	b0
Initial IP	int	192	168	39	5
	hex	C0	A8	27	05
Modified IP	int	192	168	100	240
	hex	C0	A8	64	F0

Parameter		b3	b2	b1	b0
Initial IP	int	192	168	39	5
	hex	C0	A8	27	05
Modified IP	int	192	168	100	240
	hex	C0	A8	64	F0

The following description of specific processes, after the servo power

D1	D2
5.	1.

Press key T1 of about 1s

D1	D2
P	R

Press key T1 of about 1s

D1	D2
l	P

Press key T2 of about 1s

D1	D2
l	u

Press key T2 of about 1s

D1	D2
b	0

Press key T2 of about 1s

D1	D2
b	0

1s at about T2 button to display the value of d0, the initial value is 05

D1	D2
0	5

Press T1, respectively, and T2, you can adjust the value of b0, After release, while at T1 and T2 key until the display or can be, Then press and T1 and T2, also show b0, then press the key T1 of about 1s,can switch to b2, empathy can be modified the value of b2, b3, b4, modify the good, the same press T1 and T2 until display "or" (where press T1 and T2 at the same time is the key to save and exit).

Well, after the change, restart the power, and then ping.

```
C:\WINDOWS\system32\ping.exe

Pinging 192.168.100.240 with 32 bytes of data:

Reply from 192.168.100.240: bytes=32 time=1ms TTL=255
Reply from 192.168.100.240: bytes=32 time<1ms TTL=255
Reply from 192.168.100.240: bytes=32 time<1ms TTL=255
```

After the software is connected

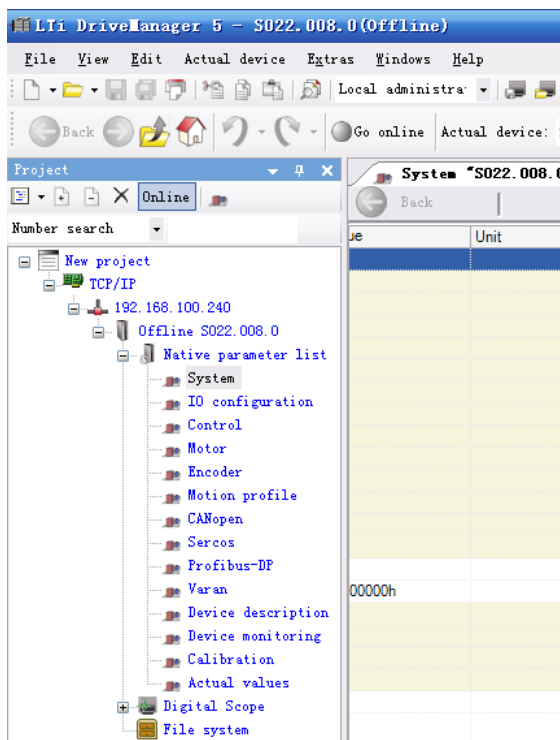

### © Supported Device

#### CDE34.008

Refer to the Controller software for details: DriveManager for c-line drives

#### ServoOne junior

Device	Bit Address	Word Address	Format	Notes
Array_DWord32	-----	0.00000-32767.65535	DDDDD.DDDDD	
Array_DWord16	-----	0.00000-32767.65535	DDDDD.DDDDD	
DWord32	-----	0-32767	DDDDD	
Word16	-----	0-32767	DDDDD	

Note: Array\_DWord32/Array\_DWord16 the address format is the primary address + decimal point + sub-address, such as the address for the save as shown below, the main address is 11, sub-address is 0, the data type is int16, then the touch screen corresponding to the address is Array\_DWord16 11.00000.

11		PARA_SetCmd		Commands for actually active parameter da
11	0	Save	0	Save actually active parameter data set
11	1	Restore	0	Restore actually active parameter data set
11	2	Reset	0	Reset actually active parameter data set to
11	3	Check	0	Check validity of actually active parameter
11	4	Register upload	0	Register start and end of data set upload

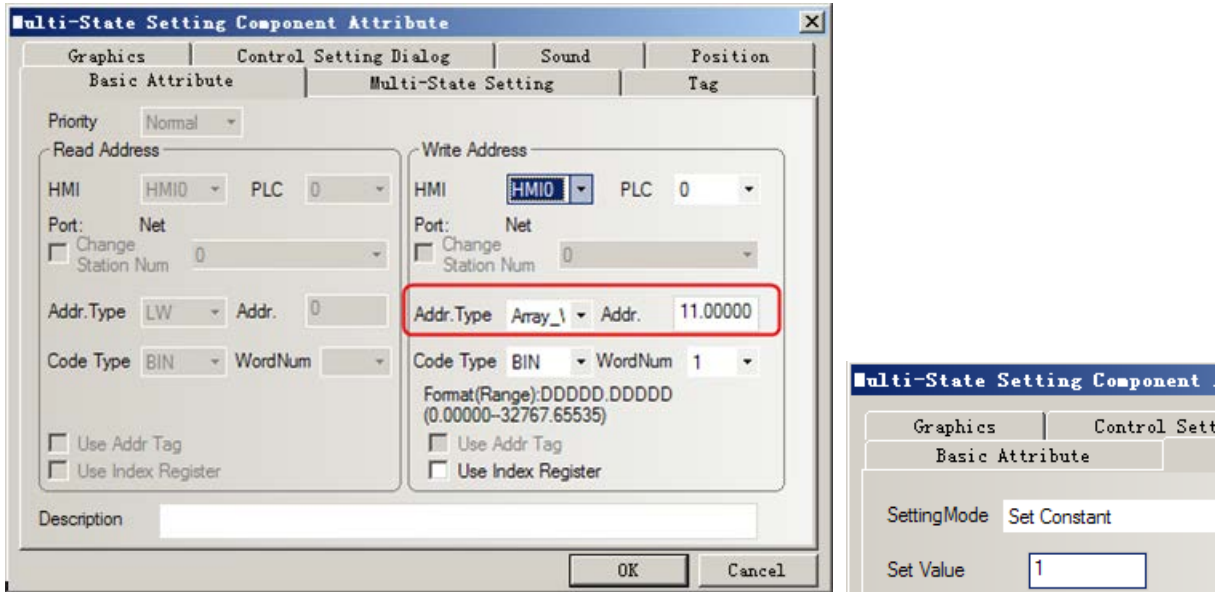

The primary address is 11, sub-address is 1, the data type is int16, then the touch screen corresponding to the address is Array\_DWord16 11.00001. In addition, INT8 address, select Word16, but also through the conversion can be displayed, as should show -3, while the display 253, which can be done in the macro data conversion, so  $253-256 = -3$ , that is in need of special address type conversion .

### ◎ Cable Diagram

#### Lustbus RS232 communication cable

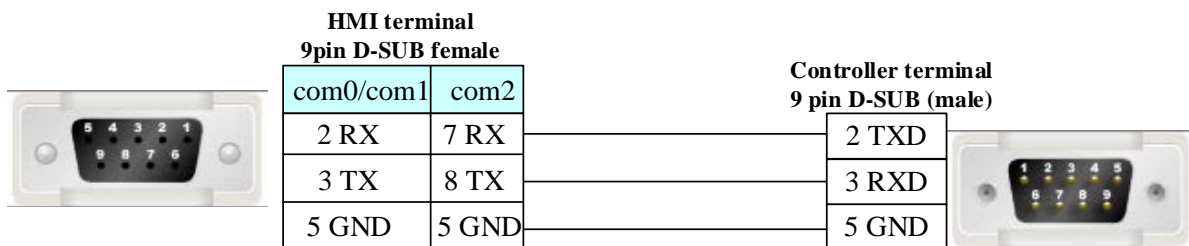

#### Ethernet communication protocol cable

Cross-connection or crossover network cable can be used as communication cable via the hub  
Refer to [3.3 Download by Network Ethernet](#) for method of making connection cable.

## 4.50 Memory map

### ◎ Serial Communication

Series	CPU	Link Module	Driver
BMS005A-MC11	BMS005A-MC11	RS422 on the CPU unit	MemoryMap(Master-Slave)

### ◎ System configuration

Series	CPU	Link Module	COMM Type	Parameter	Cable

BMS005A-MC11	BMS005A-MC11	RS422 on the CPU unit	RS422	<a href="#">Setting</a>	<a href="#">Your owner cable</a>
--------------	--------------	-----------------------	-------	-------------------------	----------------------------------

◎ **Communication Setting**

**HMI Setting**

Default communication: 57600, 8, none, 1; station: 1

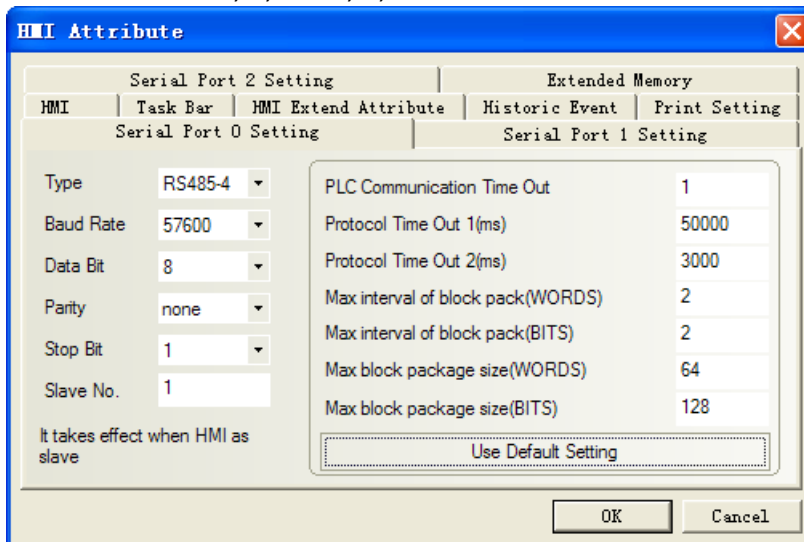

**PLC Setting**

Please refer to the manual of PLC for the configuration.

◎ **Supported Device**

Device	Bit Address	Word Address	Format
	LW.B 8000.0-8999.15	-----	DDDD.DD
	-----	LW8000-8999	DDDD

◎ **Cable Diagram**

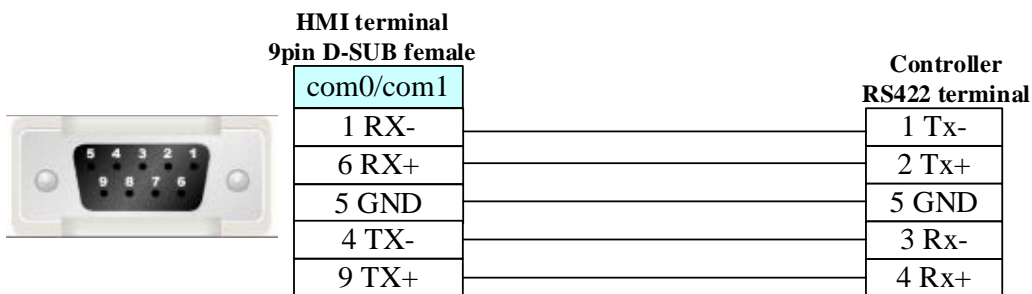

**4.51 MEGMEET**

◎ **Serial Communication**

Series	CPU	Link Module	Driver
MEGMEET MC280	MC280-1616BTA4	RS232 on the CPU unit	<a href="#">MEGMEET MC Series</a>

◎ Network communication

Series	CPU	Link Module	Driver
MC Series	MC 5100	CPU Direct	MEGMEET MC Series Ethernet (TCP Slave)

◎ Serial Communication Parameters and Cables Production

Series	CPU	Link Module	COMM Type	Parameter	Cable
MEGMEET MC280	MC280-1616 BTA4	RS232 on the CPU unit	RS232/RS485	<a href="#">Setting</a>	<a href="#">Your owner cable</a>

◎ Network System configuration

Series	CPU	Link Module	Connect Type	Parameter	Cable
MC Series	MC Series	CPU Direct	Ethernet	<a href="#">Setting</a>	<a href="#">Your owner cable</a>

◎ Serial Communication Parameters

**HMI Setting**

Default communication:9600bps, 8, even, 1; station: 1

**RS232**

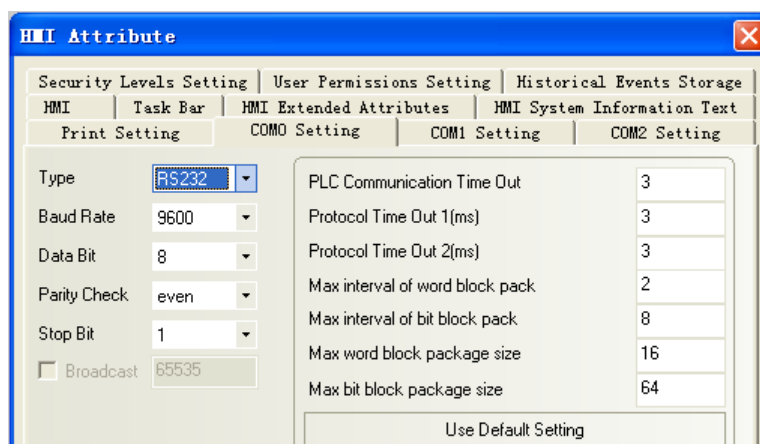

**RS485**

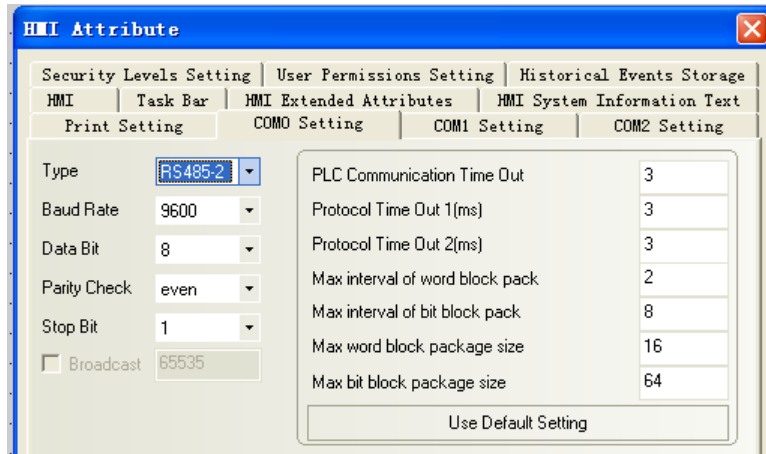

### PLC Setting

1. Open X\_builder, New project, select PLC type (MC280)

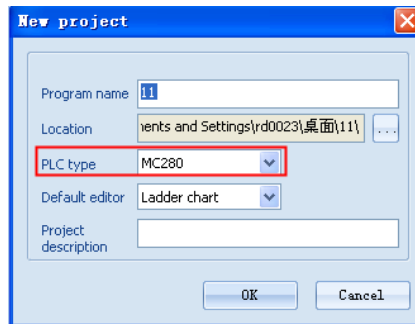

2. Open System block→Comm Port, set comm port (support Modbus)

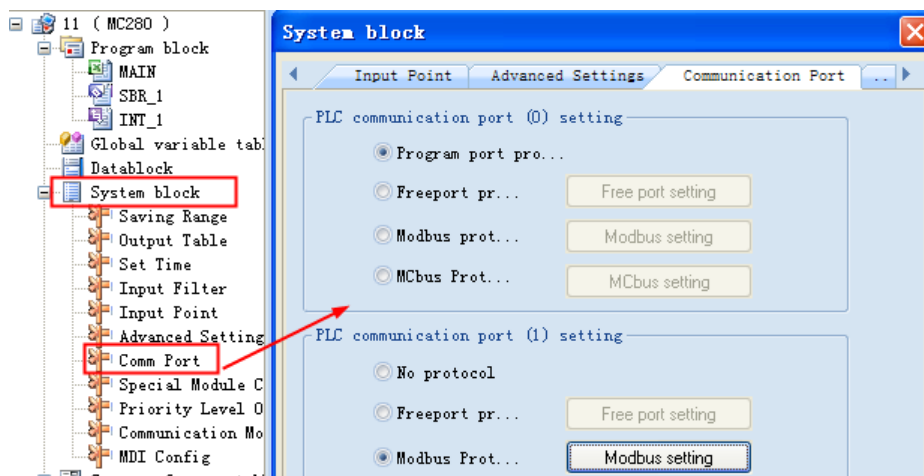

- (1) Port0 setting (RS232)

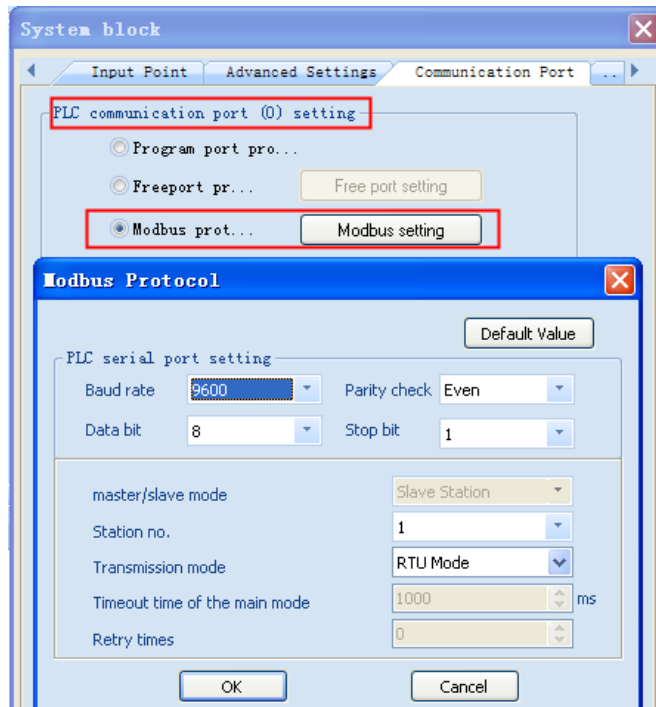

(2) PortlandPort2 setting (RS485)

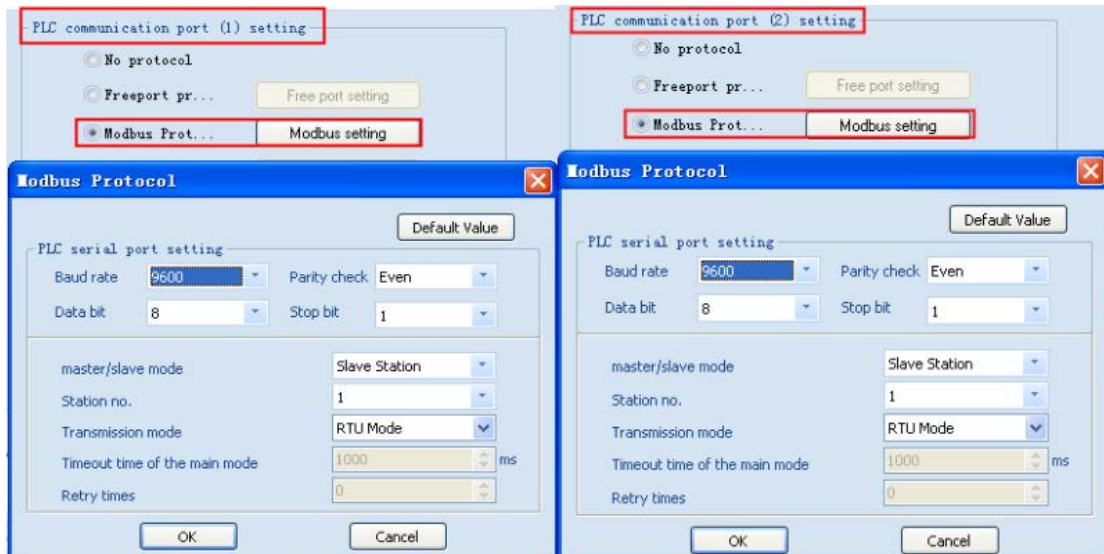

Notes: Using X\_builder, Main routine cannot be empty

## ◎ Network Communication Setting

### HMI Setting

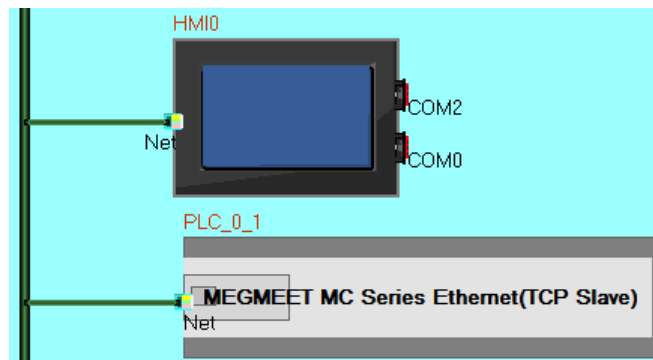



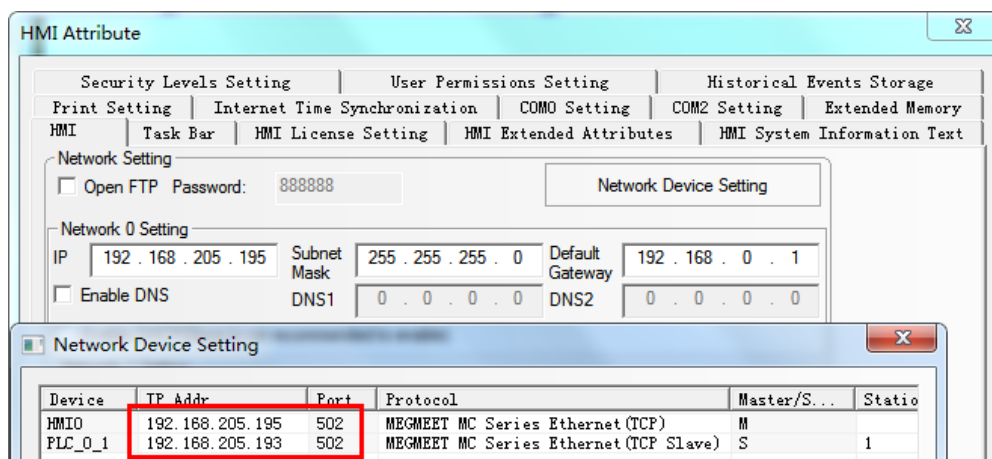

### PLC configuration

1. Open MEGcreator programming tool software, create new project, project name is optional, PLC type selects MC5100, and then click OK
2. Select the Ethernet connection in the PLC connection, the connecting IP input is the same PLC IP address that in the HMI settings, finally click OK.

### ☉ Supported Device

Device	Bit Address	Word Address	Format	Notes
Input Relay	X 0-377	-----	OOO	R
Output Relay	Y 0-377	-----	OOO	
Internal Relay	M 0-10239	-----	DDDDD	
Special Relay	SM 0-511	-----	DDD	
Step Relay	S 0-4095	-----	DDDD	
Timer Relay	T_BIT 0-511	-----	DDD	
Counter Relay	C_BIT 0-306	-----	DDD	
Data register	-----	D 0-7999	DDDD	
Special Register	-----	SD 0-511	DDD	
Index Register	-----	Z 0-15	DD	
Timer	-----	T_Word 0-511	DDD	
Counter	-----	C_Word 0-199	DDD	
Counter(double word)	-----	C_DWord 200-306	DDD	
	-----	R 0-32767	DDDDD	
	-----	R_DWord 0-32767	DDDDD	
Special Register(double word)	-----	SD_DWord 0-511	DDD	
Data register(double word)	-----	D_DWord 0-7999	DDDD	

### ☉ Cables Production

#### RS232

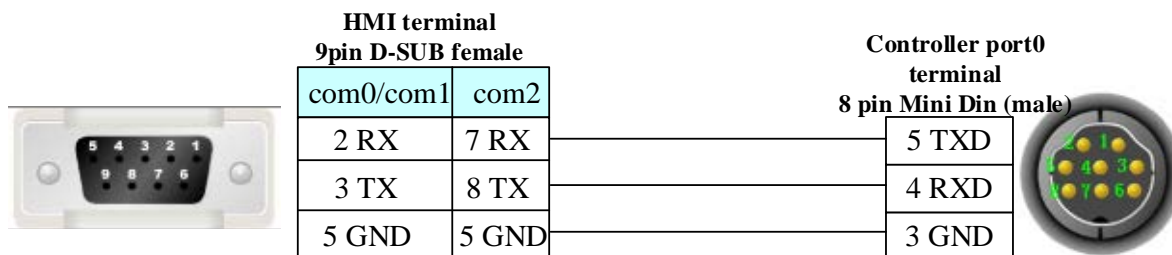

### RS485

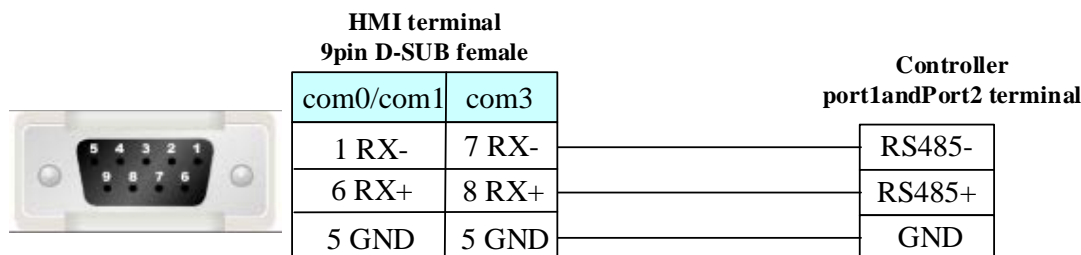

### Ethernet Cable

Cross-connection or crossover network cable can be used as communication cable via the hub  
Refer to [3.3 Download by Network Ethernet](#) for method of making connection cable.

## 4.52 Mikom

### ◎ Serial Communication

Series	CPU	Link Module	Driver
MX2H	MX2H-3232M	RS232 on the CPU unit	Mikom MXxh
		RS485 on port	

### ◎ System configuration

Series	CPU	Link Module	COMM Type	Parameter	Cable
MX2H	MX2H-3232M	Port 0	RS232	<a href="#">Setting</a>	<a href="#">Your owner cable</a>
		Port 1	RS485	<a href="#">Setting</a>	<a href="#">Your owner cable</a>

### ◎ Communication Setting

#### HMI Setting

Default communication parameters 19200, 7, 1, even; Station: 1

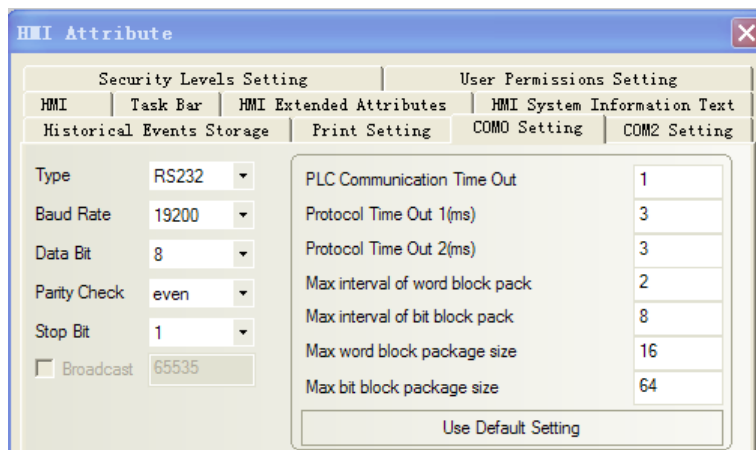

### PLC Setting



### ◎ Supported Device

Device	Bit Address	Word Address	Format
Input Relay	X 0-777		OOO
Output Relay	Y 0-777		OOO
Counter	C_bit 0-511		DDD
Timer	T_bit 0-511		DDD
Status Relay	S 0-1535		DDDD
Special Relay	SM 0-511		DDD
Internal Relay	M 0-4095		DDDD
Data register		D 0-7999	DDDD
Special Register(double word)		SD 0-511	DDD
Index Register		Z 0-255	DDD
Timer		T_word 0-255	DDD
Counter		C_word 0-199	DDD

**NOTE:** The PLC MODBUS protocol does not support double-word data type, so the protocol does not support the bulk of the word read and write .

### ◎ Cable Diagram

#### RS232 Communication

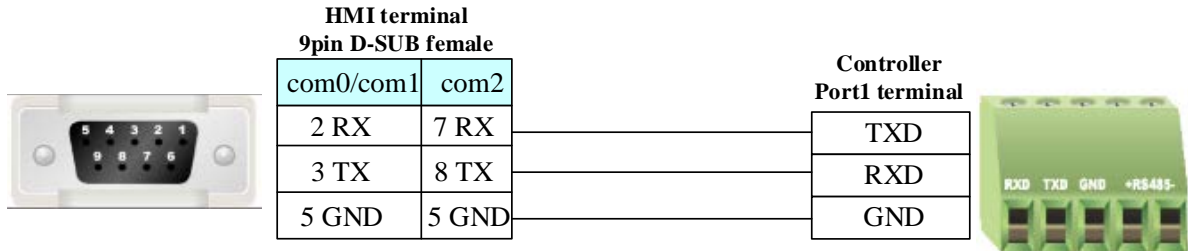
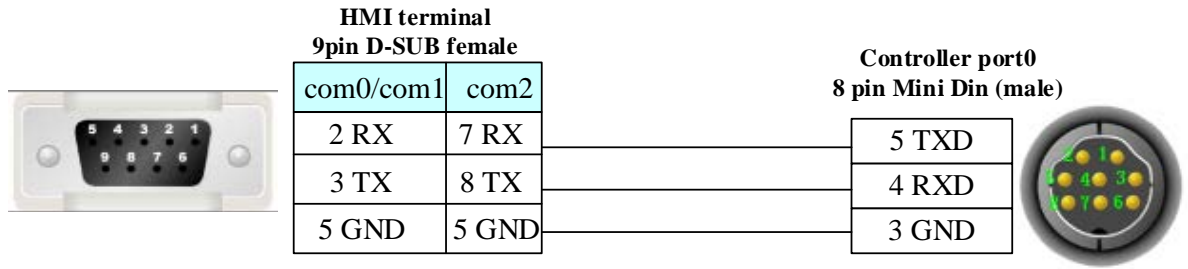

**RS485 Communication**

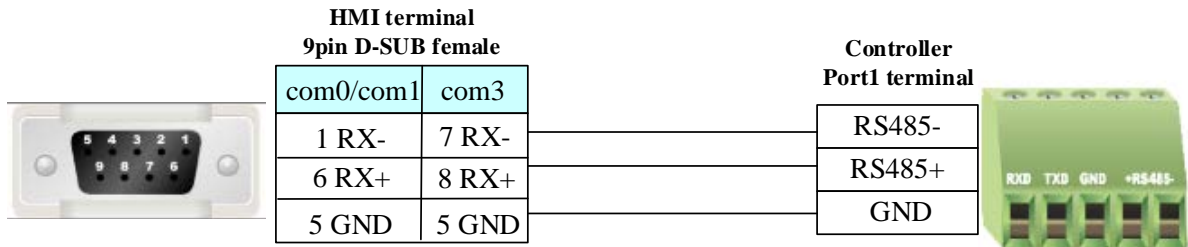

**4.53 Millenium3**

◎ **Serial Communication**

Series	CPU	Link Module	Driver
Millenium 3	Millenium 3	RS232 on the CPU unit	Millenium 3
		RS485 on the CPU unit	

◎ **System configuration**

Series	CPU	Link Module	COM Type	Parameter	Cable
Millenium 3	Millenium 3	RS232 on the CPU unit	RS232	<a href="#">Setting</a>	<a href="#">Your owner cable</a>
		RS485 on the CPU unit	RS485	<a href="#">Setting</a>	<a href="#">Your owner cable</a>

◎ **Communication Setting**

**HMI Setting**

Default communication parameters 115200, 7, 1, even; Station: 1

**RS232 Communication:**

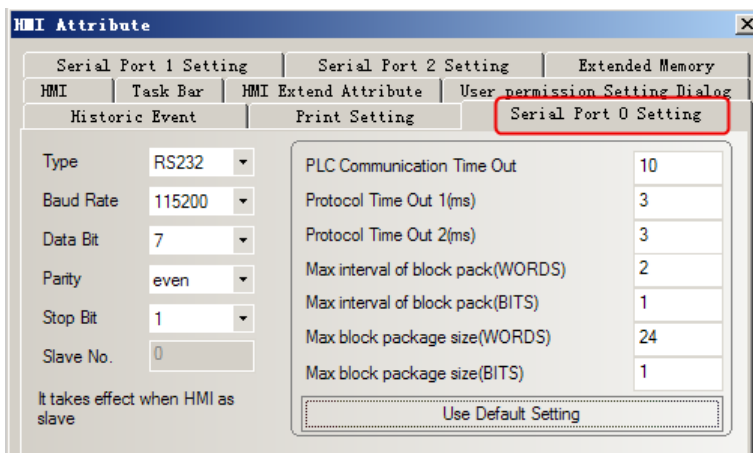

**RS485 Communication:**

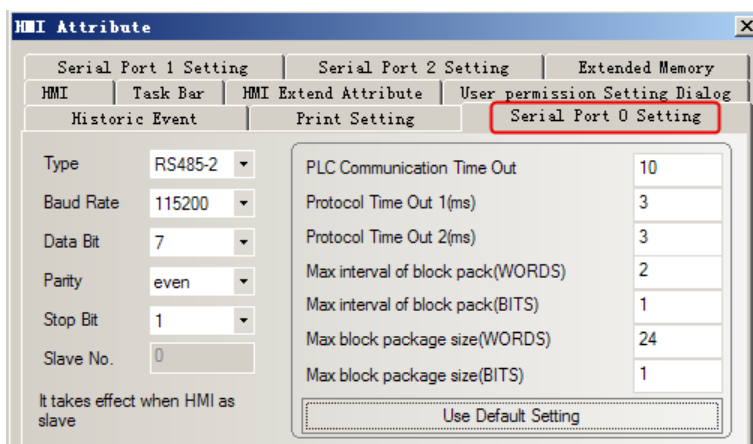

◎ **Supported Device**

Device	Bit Address	Word Address	Format	Notes
Register	-----	Register 0~23	DD	Write only
Register	-----	Register 24~47	DD	Read only

◎ **Cable Diagram**

**RS232**

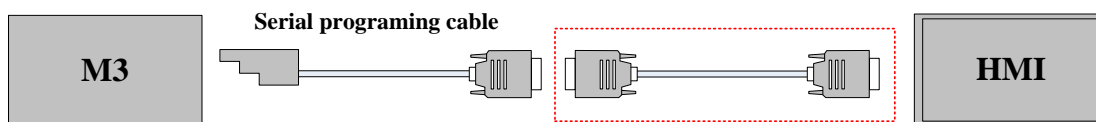

Users need to make the communication cable for M3 and HMI (region of red marquee as shown above) M3 communicate with COM0/COM1 of HMI, the cable connection is as follow:

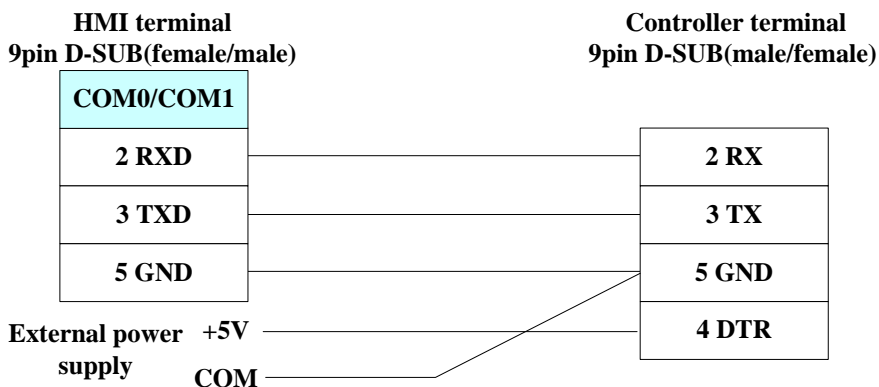

**NOTE:** Provide 5V DC high level for the pin 4 of M3 9-pin D-Sub.

**RS485**

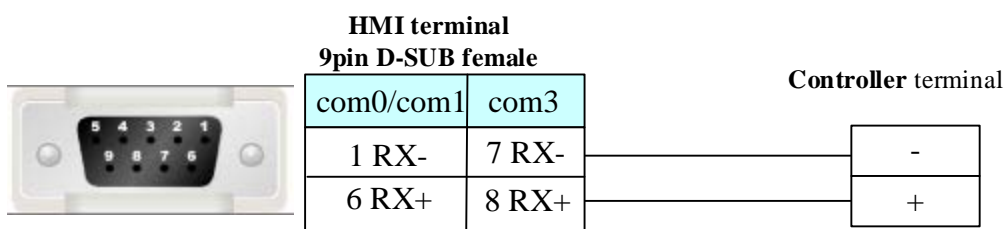

**4.54 Mitsubishi Electric Corporation**

**Serial Communication**

Series	CPU	Link Module	Driver
FXCPU	FX0S	CPU Direct	Mitsubishi FX1S*2
	FX1S	FX□□-422-BD*3	
	FX0N	FX□□-485-BD*3	Mitsubishi FX1S*2
	FX1N		Mitsubishi FX-485ADP/485BD/232BD (Multi-station) *1
	FX2	FX□□-485-ADP*3	Mitsubishi FX2N/3G*2
	FX3S		
	FX1NC	CPU Direct	
	FX2N	FX□□-422-BD*3	
	FX2NC	FX□□-485-BD*3	Mitsubishi FX2N/3G*2
	FX3SA	FX□□-485-ADP*3	
		FX□□-232-BD*3	Mitsubishi FX-485ADP/485BD/232BD (Multi-station) *1
	FX2N-10GM	CPU Direct	Mitsubishi FX2N_10GM/20GM
	FX2N-20GM		
	FX3U	CPU Direct	Mitsubishi FX3U*2
	FX3UC	FX□□-422-BD*3	
		FX□□-485-BD*3	Mitsubishi FX3U*2
		FX□□-485-ADP*3	

		FX□□-232-BD* <sup>3</sup>	
	FX5U-32M	RS422 on the CPU unit	Mitsubishi FX5U
		FX5-232ADP	
	FX3G FX3GE	CPU Direct	Mitsubishi FX2N/3G* <sup>2</sup>
QCPU	Q00jCPU	RS232 on the CPU unit	Mitsubishi Q00J (CPU Port)
		QJ71C24 QJ71C24-R2 QJ71C24N QJ71C24N-R2 QJ71C24N-R4	1. Mitsubishi Q_QnA (Link Port) 2. Mitsubishi Melsec Q
	Q00CPU Q01CPU	RS232 on the CPU unit	1. Mitsubishi Q_QnA (Link Port) 2. Mitsubishi Melsec Q
		QJ71C24 QJ71C24-R2 QJ71C24N QJ71C24N-R2 QJ71C24N-R4	
	Q01UCPU Q03UDCPU Q06UDHCPU	RS232 on the CPU unit	Mitsubishi Q series (CPU Port)
	Q02CPU Q02HCPU Q25HCPU	RS232 on the CPU unit	Mitsubishi Q series (CPU Port) Mitsubishi Q06Hv2* <sup>4</sup>
		QJ71C24 QJ71C24-R2 QJ71C24N QJ71C24N-R2 QJ71C24N-R4	1. Mitsubishi Q_QnA (Link Port) 2. Mitsubishi Melsec Q
	Q12HCPU	RS232 on the CPU unit	Mitsubishi Q06Hv2* <sup>4</sup>
	Q00UJCPU	RS232 on the CPU unit	Mitsubishi Q_QnA (Link Port)
	Q02UCPU	RS232 on the CPU unit	Mitsubishi Melsec Q
	Q06HCPU	RS232 on the CPU unit	Mitsubishi Q06H Mitsubishi Q06Hv2* <sup>4</sup>
LCPUCPU	L02CPU	LJ71C24-CM	Mitsubishi Q_QnA (Link Port)
	L02SCPU	RS232 on the CPU unit	

- NOTE:** 1. \*<sup>1</sup> The protocol support multi-station  
2. \*<sup>2</sup> The protocol don't support multi-station  
3. \*<sup>3</sup> □□ means the module that is suitable for the PLC  
4. \*<sup>4</sup> The protocol support to modify the device points, only to support Q06HCPU and Q02HCPU.

### © Network Communication (Direct online simulation disable)

Series	CPU	Link Module	Driver
--------	-----	-------------	--------

FXCPU	FX3GE-24M	Ethernet port on CPU unit	Mitsubishi FX Series Ethernet(TCP Slave)
	FX3U-32M	FX3U-ENET-L	
	FX5U-32MT/ES	Ethernet port on CPU uni	Mitsubishi FX5U Series Ethernet(TCP Slave)
QCPU	Q00CPU Q00JCPU Q01CPU Q02CPU Q02HCPU Q06HCPU Q12HCPU Q25HCPU Q03UDECPU Q04UDEHCPU Q06UDEHCPU Q13UDEHCPU Q26UDEHCPU	QJ71E71 QJ71E71-B2 QJ71E71-B5 QJ71E71-100	Mitsubishi QJ71E71 EtherNet Slave
	Q02UCPU Q03UDCPU Q04UDHCPU Q06UDHCPU Q13UDHCPU Q26UDHCPU	QJ71E71 QJ71E71-B2 QJ71E71-B5 QJ71E71-100	
LCPU	L02CPU L26CPU-BT	Ethernet port on CPU unit	Mitsubishi QnA 3EBin Ethernet(TCP Slave)
QCPU	Q03UDECPU Q04UDEHCPU Q26UDV CPU	Ethernet port on CPU unit	

### ◎ Serial System configuration

Series	CPU	Link Module	COMM Type	Parameter	Cable	
FXCPU	FX0S	RS485 on the CPU unit	RS232	<a href="#">Setting</a>	<a href="#">Your owner cable</a>	
	FX1S	FX□□-422-BD	RS422	<a href="#">Setting</a>	<a href="#">Your owner cable</a>	
	FX0N	FX□□-485-BD FX□□-485-ADP	RS422	<a href="#">Setting</a>	<a href="#">Your owner cable</a>	
	FX1N					
	FX2					
	FX3S	FX1NC FX2N FX2NC FX3SA	RS485 on the CPU unit	RS232	<a href="#">Setting</a>	<a href="#">Your owner cable</a>
	FX1NC		FX□□-422-BD	RS422	<a href="#">Setting</a>	<a href="#">Your owner cable</a>
	FX2N		FX□□-485-BD	RS422	<a href="#">Setting</a>	<a href="#">Your owner cable</a>
	FX2NC		FX□□-485-ADP			
	FX3SA		FX□□-232-BD	RS232	<a href="#">Setting</a>	<a href="#">Your owner cable</a>
FX2N-10GM	RS485 on the CPU unit	RS232	<a href="#">Setting</a>	<a href="#">Your owner cable</a>		



	FX2N-20GM		RS422	<a href="#">Setting</a>	<a href="#">Your owner cable</a>	
	FX3G	RS485 on the CPU unit	RS232	<a href="#">Setting</a>	<a href="#">Your owner cable</a>	
	FX3GE		RS422	<a href="#">Setting</a>	<a href="#">Your owner cable</a>	
	FX3UC FX3U	RS485 on the CPU unit	RS232	<a href="#">Setting</a>	<a href="#">Your owner cable</a>	
		FX□□-422-BD	RS422	<a href="#">Setting</a>	<a href="#">Your owner cable</a>	
		FX□□-485-BD FX□□-485-ADP	RS422	<a href="#">Setting</a>	<a href="#">Your owner cable</a>	
	FX5U	FX□□-232-BD	RS232	<a href="#">Setting</a>	<a href="#">Your owner cable</a>	
		RS485 on the CPU unit	RS422	<a href="#">Setting</a>	<a href="#">Your owner cable</a>	
	FX5-232ADP	RS232	<a href="#">Setting</a>	<a href="#">Your owner cable</a>		
Melsec Q	Q00jCPU	RS232 on the CPU unit	RS232	<a href="#">Setting</a>	<a href="#">Your owner cable</a>	
	Q00CPU Q01CPU	RS232 on the CPU unit	RS232	<a href="#">Setting</a>	<a href="#">Your owner cable</a>	
	Q00jCPU Q00CPU Q01CPU Q02CPU	QJ71C24 QJ71C24-R2 QJ71C24N QJ71C24N-R2	RS232	<a href="#">Setting</a>	<a href="#">Your owner cable</a>	
	Q02HCPU Q03UDCPU Q25HCPU	QJ71C24 QJ71C24N QJ71C24N-R4	RS422	<a href="#">Setting</a>	<a href="#">Your owner cable</a>	
	Q00UJCPU	RS232 on the CPU unit	RS232	<a href="#">Setting</a>	<a href="#">Your owner cable</a>	
	Q02CPU Q02HCPU Q01UCPU Q02UCPU Q03UDCPU Q06HCPU Q06UDHPU Q25HCPU	RS232 on the CPU unit	RS232	<a href="#">Setting</a>	<a href="#">Your owner cable</a>	
	Q06HCPU Q12HCPU	RS232 on the CPU unit	RS232	<a href="#">Setting</a>	<a href="#">Your owner cable</a>	
	LCP	L02CPU	LJ71C24-CM	RS232	<a href="#">Setting</a>	<a href="#">Your owner cable</a>
				RS422		<a href="#">Your owner cable</a>
		L02SCPU	RS232 on the CPU unit	RS232	<a href="#">Setting</a>	<a href="#">Your owner cable</a>

### ◎ Network System configuration

Series	CPU	Link Module	Connect Type	Parameter	Cable
FXCPU	FX3GE-24M	Ethernet port on CPU unit	Ethernet	<a href="#">Setting</a>	<a href="#">Your owner cable</a>
	FX3U-32M	FX3U-ENET-L			
	FX5U-32MT/ES	Ethernet port on CPU unit	Ethernet	<a href="#">Setting</a>	<a href="#">Your owner cable</a>
Melsec Q	Q00CPU	QJ71E71	Ethernet		

	Q00JCPU Q01CPU Q02CPU Q02HCPU Q06HCPU Q12HCPU Q25HCPU Q03UDECPU Q04UDEHCPU Q06UDEHCPU Q13UDEHCPU Q26UDEHCPU	QJ71E71-B2 QJ71E71-B5 QJ71E71-100			
	Q02UCPU Q03UDCPU Q04UDHCPU Q06UDHCPU Q13UDHCPU Q26UDHCPU	QJ71E71 QJ71E71-B2 QJ71E71-B5 QJ71E71-100	Ethernet	<a href="#">Setting</a>	<a href="#">Your owner cable</a>
MELSEC L	L02CPU L26CPU-BT	Ethernet port on CPU unit	Ethernet	<a href="#">Setting</a>	<a href="#">Your owner cable</a>
QCPU	Q26UDV CPU Q04UDEHCPU Q03UDECPU	Ethernet port on CPU unit	Ethernet	<a href="#">Setting</a>	<a href="#">Your owner cable</a>

◎ Serial Communication Setting

Mitsubishi FX1S、Mitsubishi FX0N/1N/2N/3G、Mitsubishi FX3U protocol  
HMI Setting

Default communication: 9600, 7, even, 1; station: 0

RS232 communication

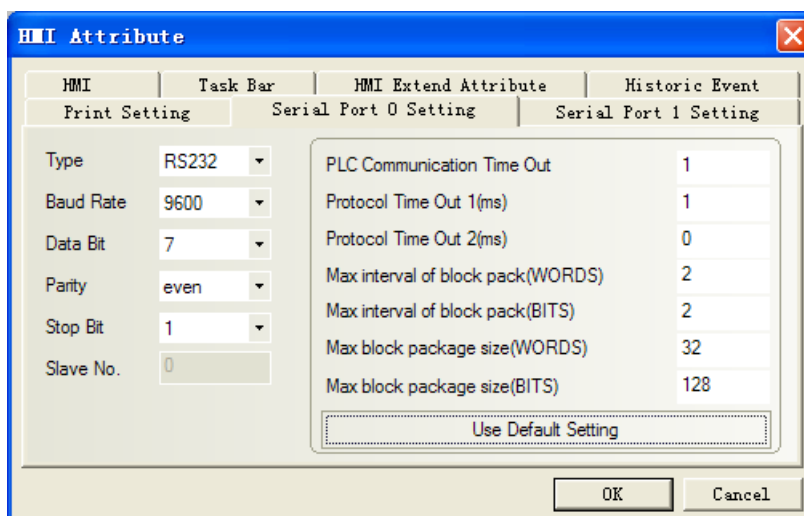

RS422 communication

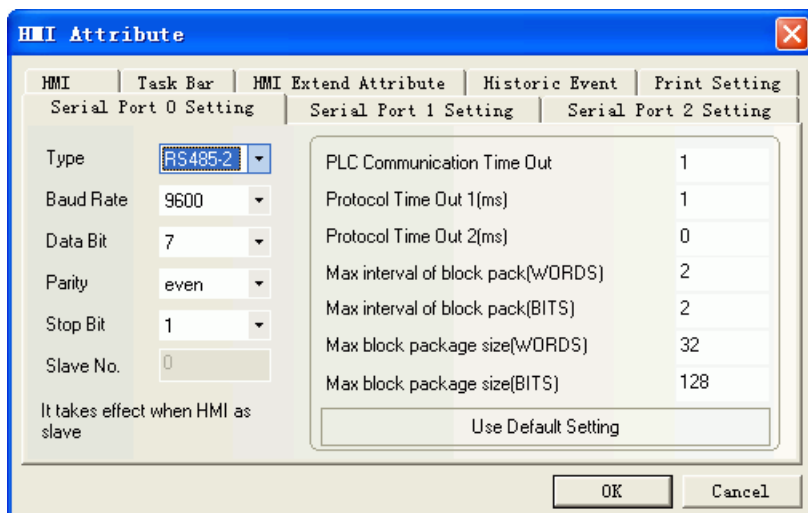

### HMI Setting

When using the Mitsubishi FX1S、Mitsubishi FX0N/1N/2N/3G、Mitsubishi FX3U protocol, PLC configuration is as follow:

Don't select "Operate communication setting", and click "default"

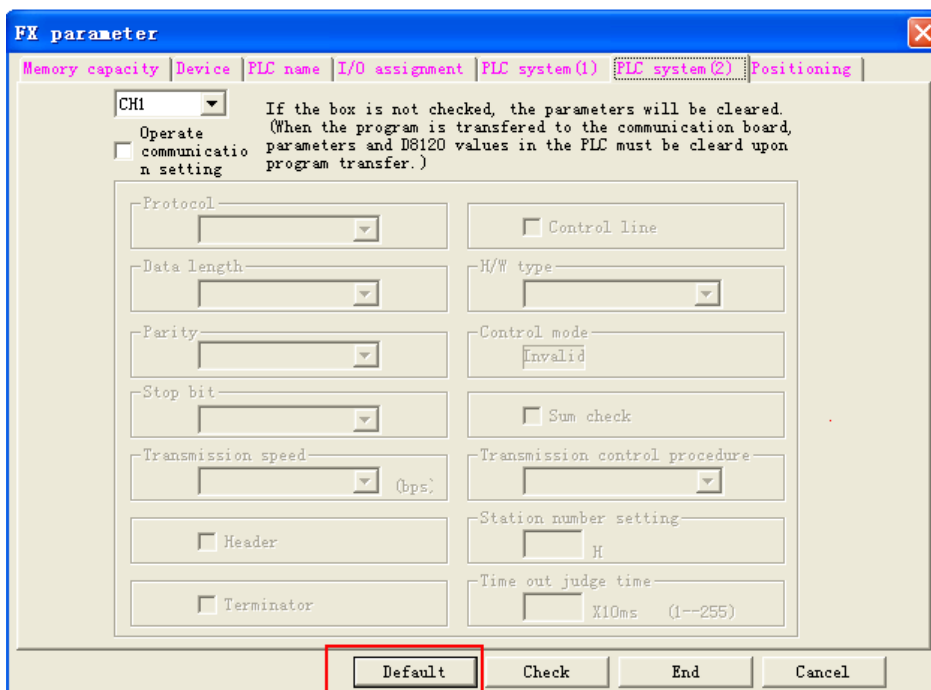

#### NOTE:

1. If you do not use the multi-station when using communication module, you can choose the protocol of Mitsubishi FX1S、Mitsubishi FX0N/1N/2N/3G、Mitsubishi FX3U etc. according to the PLC model
2. Make sure that the value of D8120 is 0 when using the communication module

### Mitsubishi FX-485ADP/485BD/232BD (Multi-station) protocol

#### HMI Setting

Default communication: 19200, 7, even, 2; station: 0

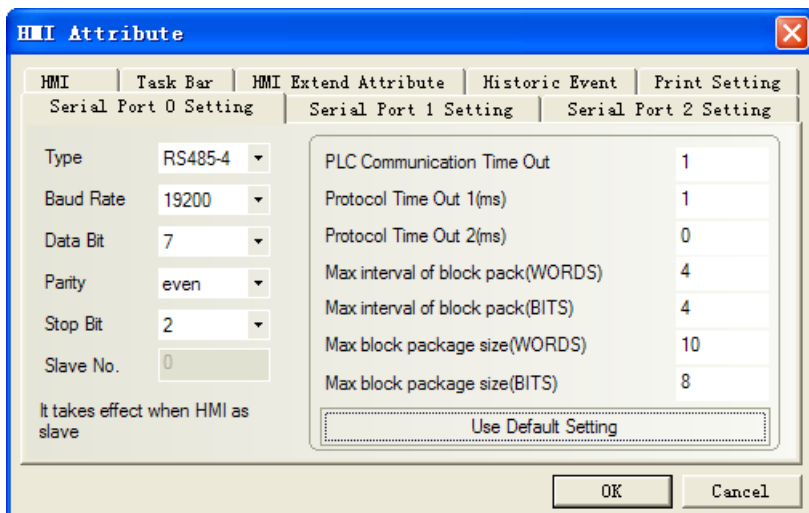

### PLC Setting

Select the “Operate communication setting”

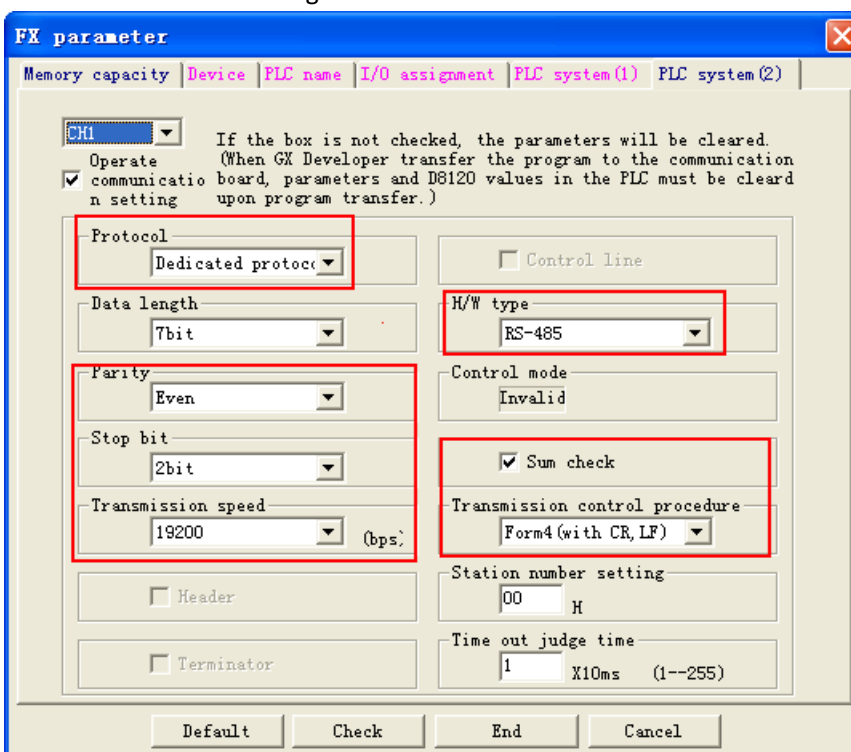

**NOTE:**

1. FX0N series don't support the “Operate communication setting”, but the communication parameters can be modified by setting the value of D8120、 D8121、 D8129
2. If series of PLC is FX3U/3UC, you must select “CH1”
3. Select the “Dedicated protocol” and check “Sum check” option, Transmission control procedure must be Form4
4. If you use the FX□□-232-BD module, set H/W type to Regular/RS-232C; if you use the FX□□-485-BD/FX□□-485-ADP module, set H/W type to RS-485

The communication parameters can be modified by setting the value of D8120/D8121/D8129

Special register	Description
------------------	-------------

D8120	Communication format
D8121	Station number
D8129	Overtime

**For example**

The communication parameters of PLC as follow:

Communication format: 9600bps, 7, even, 2;

Station No.:1;

H/W type: RS485;

Time out: 1

Set the value of D8120/D8121/D8129:

D8120=0xE08E;

D8121=1;

D8129=1;

**NOTE:** Restart the PLC after setting the value of D8120.

**FX2N-10G/20GM protocol**

Default communication: 9600, 8, even, 1; station: 0

**RS232 communication**

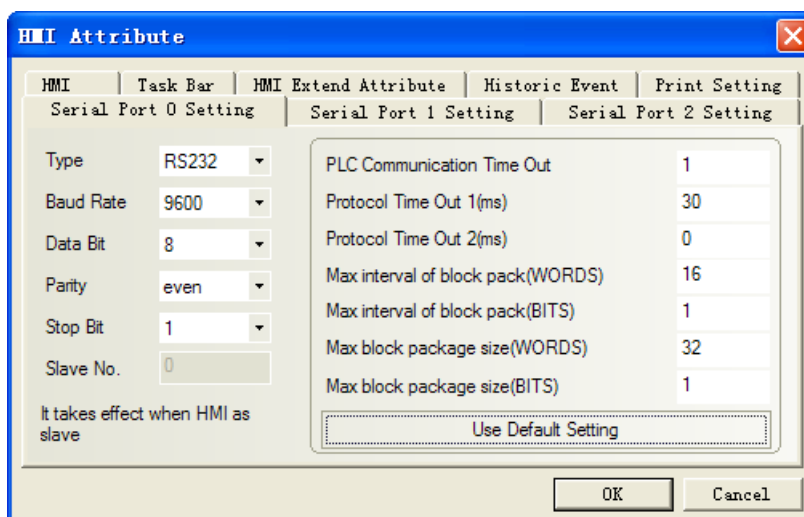

**RS422 communication**

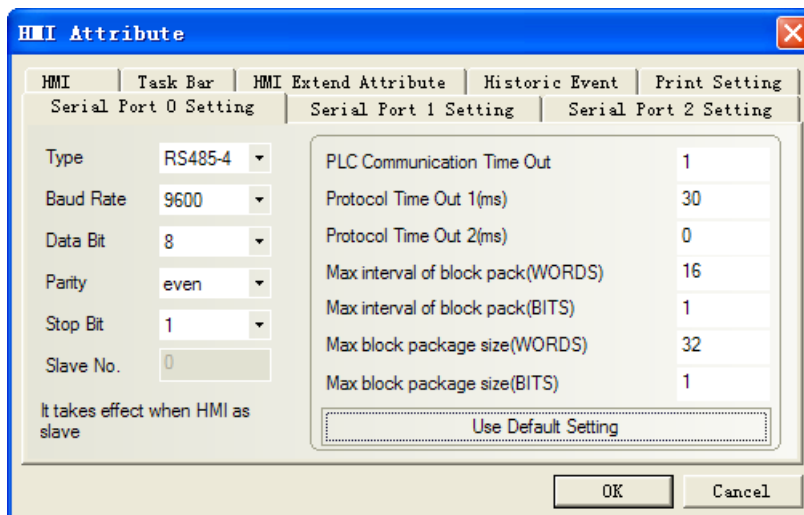

## Mitsubishi FX5U protocol HMI Setting

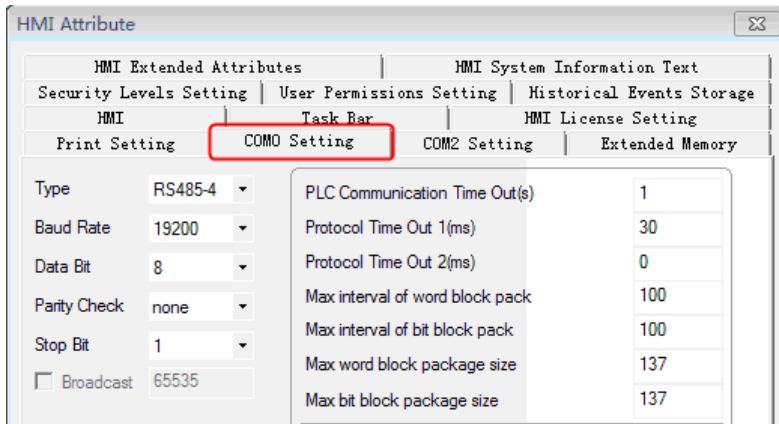

## PLC Setting

a. CPU 485 Serial Port Setting

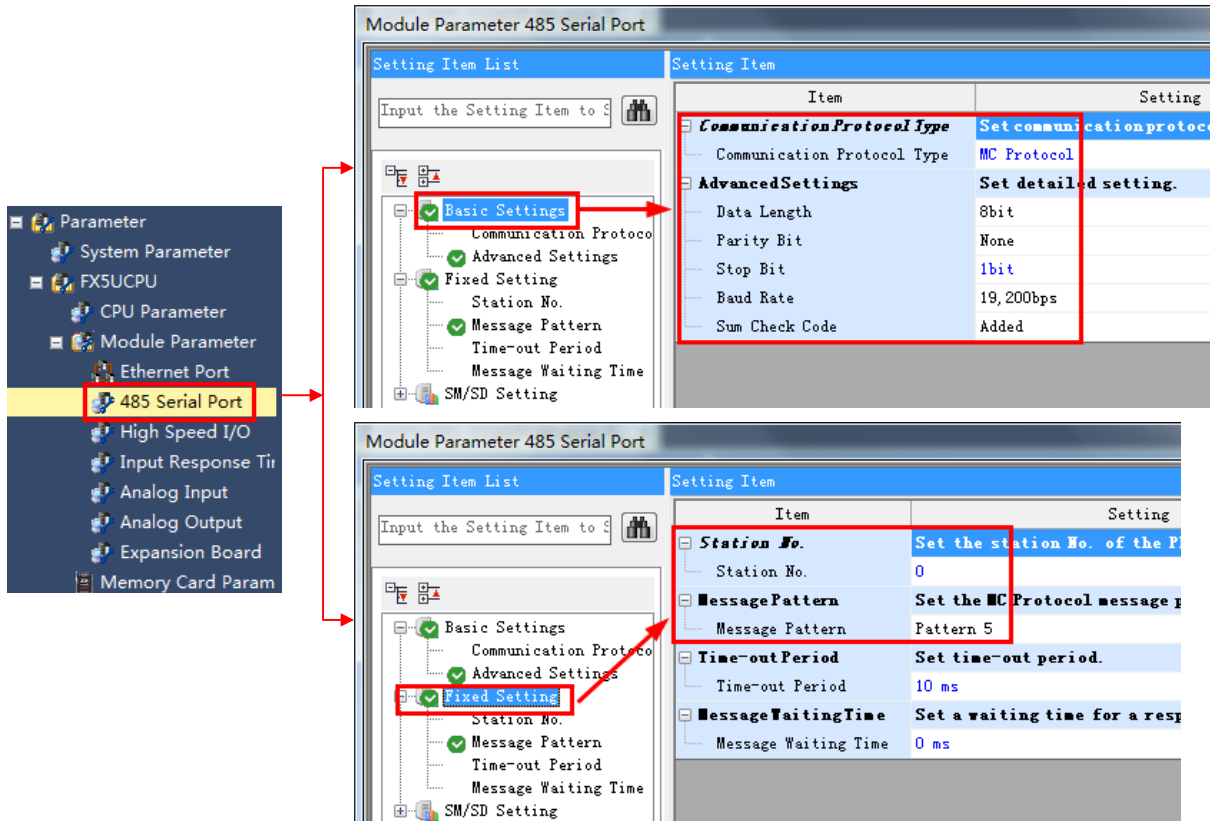

b. FX5-232ADP Setting

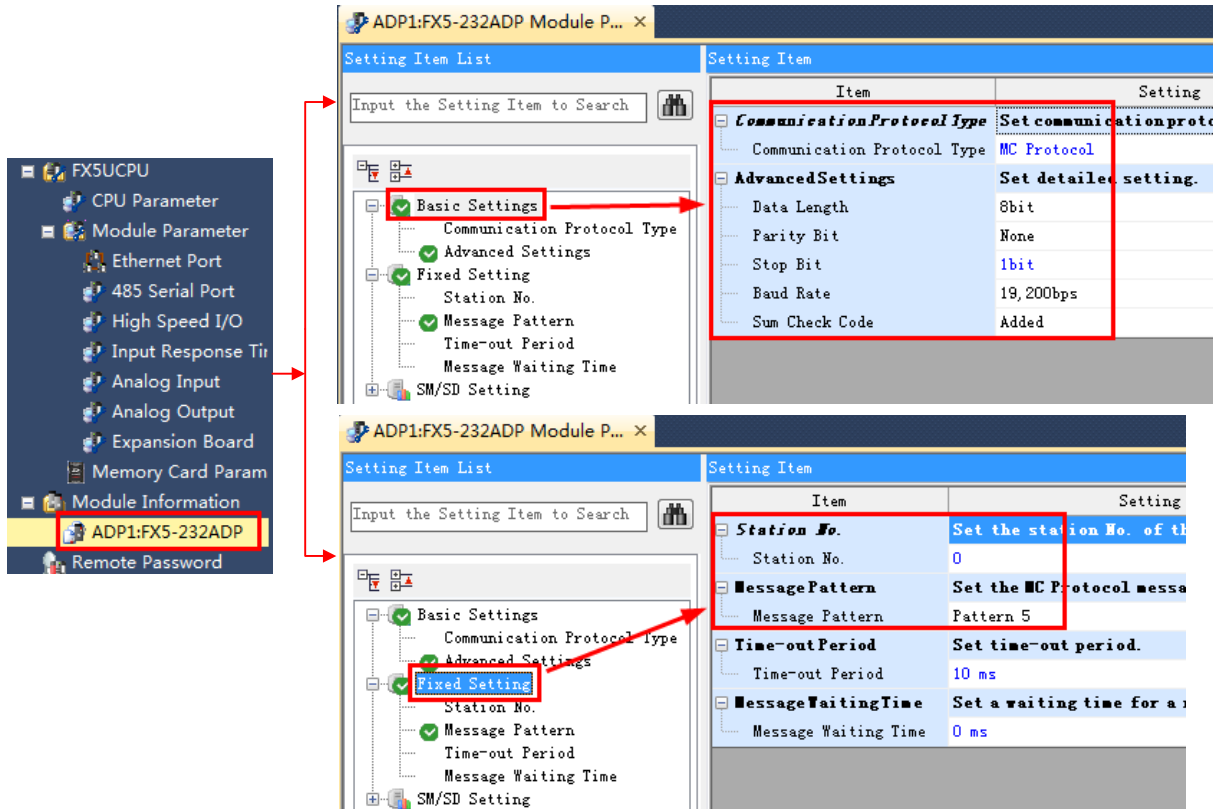

c. After setting, click [Apply] button, then write to PLC.

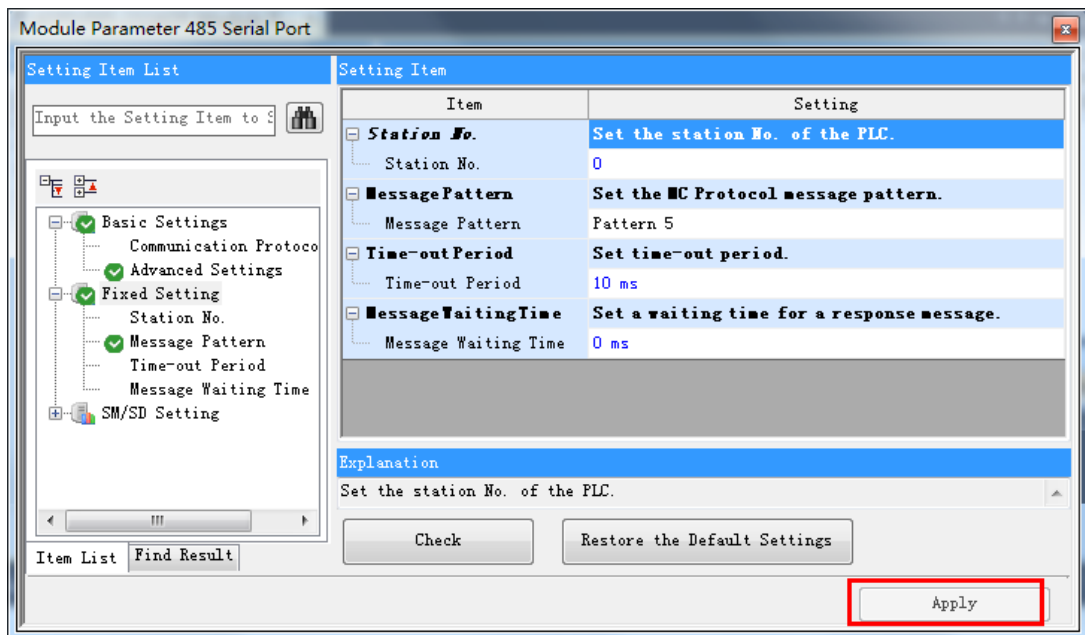

**Mitsubishi Q00J (CPU Port) protocol**

**HMI Setting**

Default parameters: 19200, 8, odd, 1; Station No.: 0(Non-support station number, only one HMI connect to one PLC)

**RS232 communication**

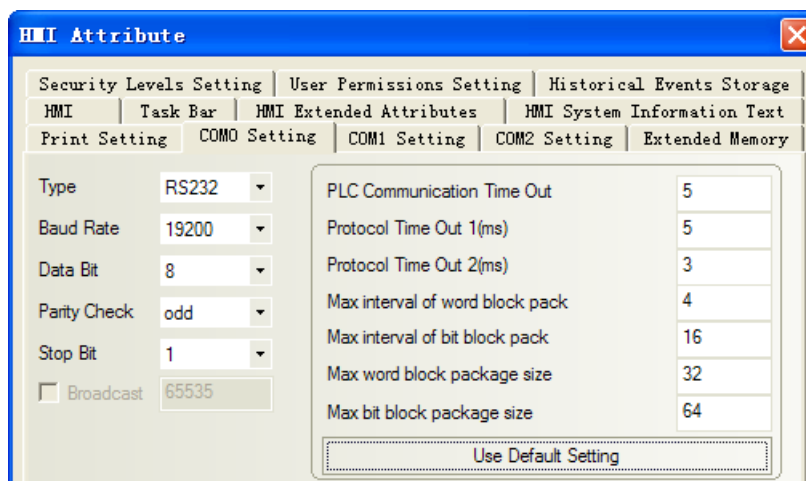
**NOTE:**

- 1、 If communication baudrate is error, HMI automatically set PLC baudrate for the HMI baudrate. It is not necessary to consider whether the PLC communications baudrate being true.
- 2、 This drives support password protection model Q00J.

**Mitsubishi Q series (CPU Port) protocol****HMI Setting**

Default parameters :115200, 8, odd, 1 ; Station No. : 0(Non-support station number, only one HMI connect to one PLC)

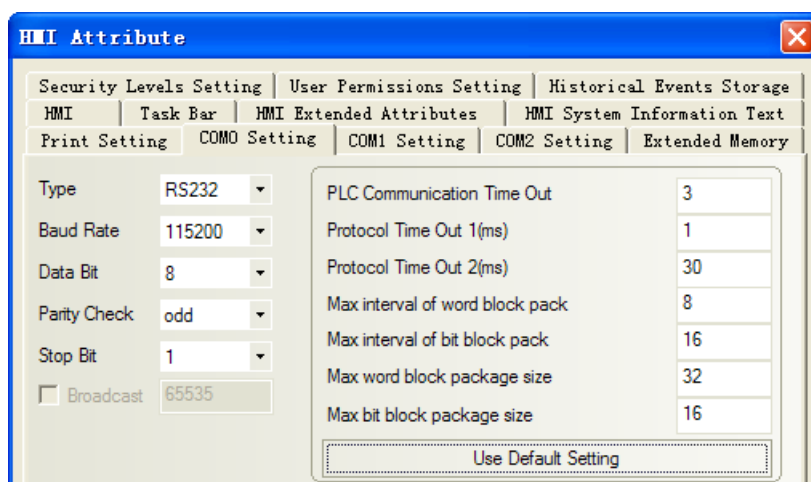
**RS232C communication**

**NOTE:** If communication baudrate is error, HMI automatically set PLC baudrate for the HMI baudrate. It is not necessary to consider whether the PLC communications baudrate being true.

**Mitsubishi Q06H 、 Mitsubishi Q06Hv2 protocol****HMI Setting**

Default parameters :115200, 8, odd, 1 ; Station No. : 0(Non-support station number, only one HMI connect to one PLC)

**RS232C communication**



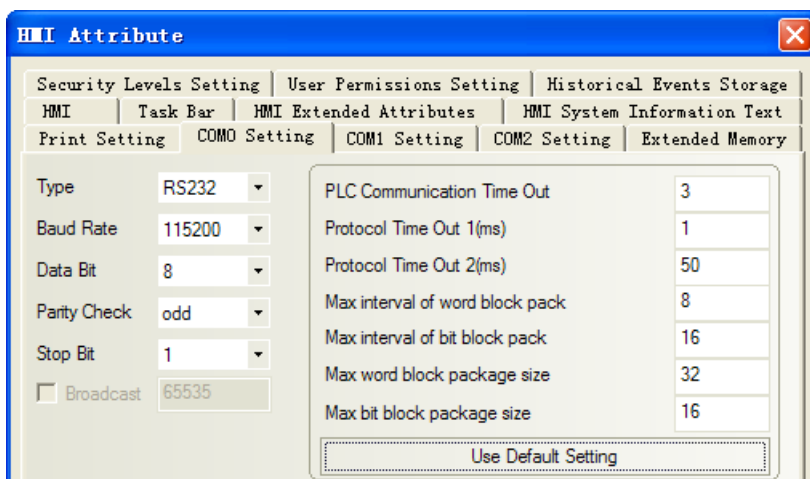

**NOTE:** If communication baudrate is error, HMI automatically set PLC baudrate for the HMI baudrate. It is not necessary to consider whether the PLC communications baudrate being true.

### Mitsubishi Q\_QnA (Link Port) & Mitsubishi Melsec Q protocol

#### HMI Setting

Default parameters :9600, 8, odd, 1 ; Station No. : 0

#### RS232 communication

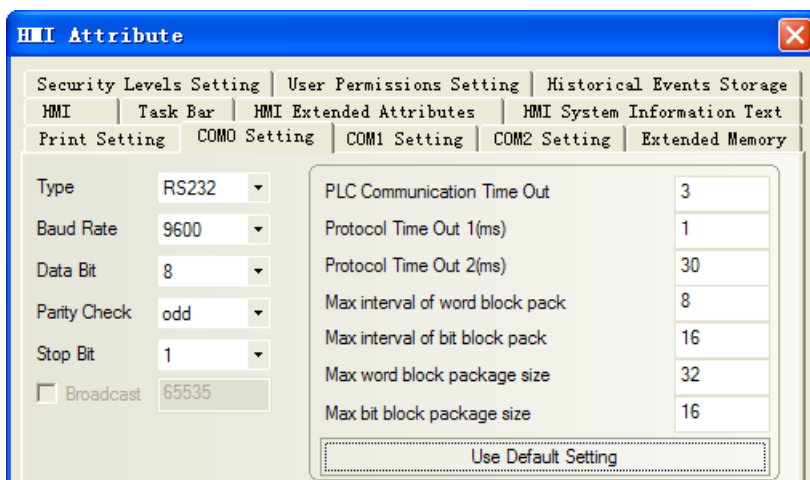

#### RS422 communication

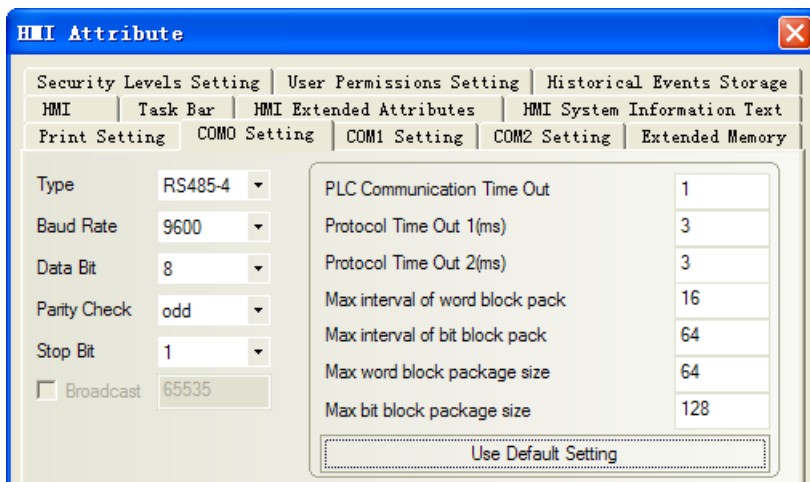

**The differences of Mitsubishi Q\_QnA (Link Port)、Mitsubishi Melsec Q:**

1. Mitsubishi Q\_QnA (Link Port) protocol advantage is communication speed
2. Mitsubishi Melsec Q protocol advantages is that it support RS232 and RS485 communication modules, disadvantage is that communication is slow.

**HMI Setting**

1. CPU port communication

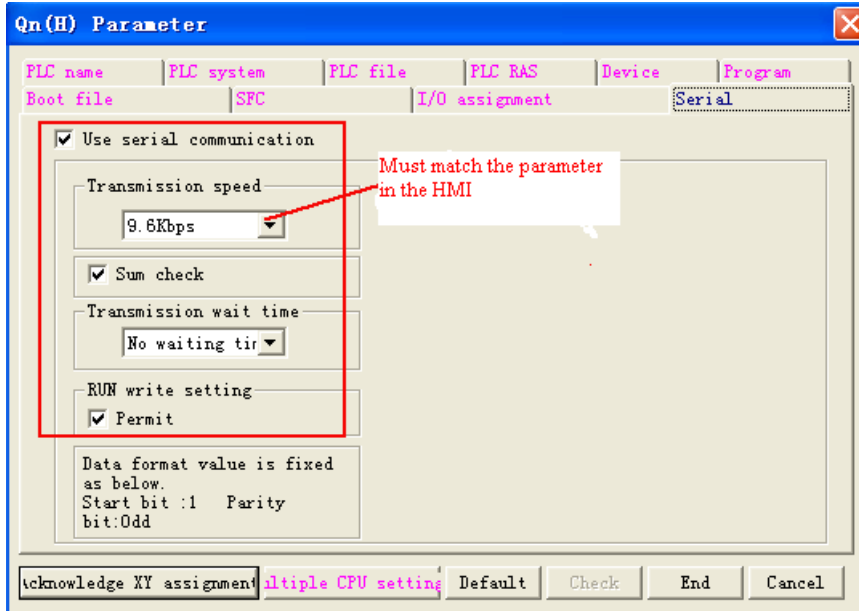

2. C24 module communication

a. "Parameter" double-click "PLC parameter", select "I/O assignment".

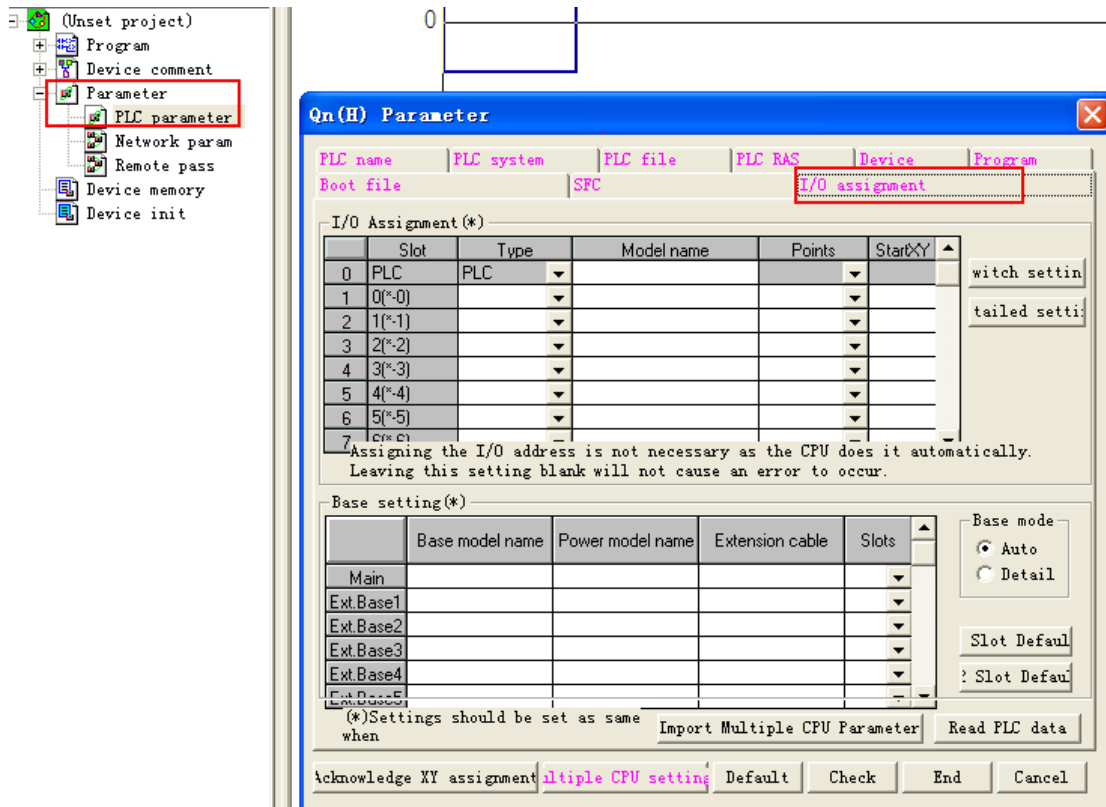

b. Click "type" to select "intelligent"

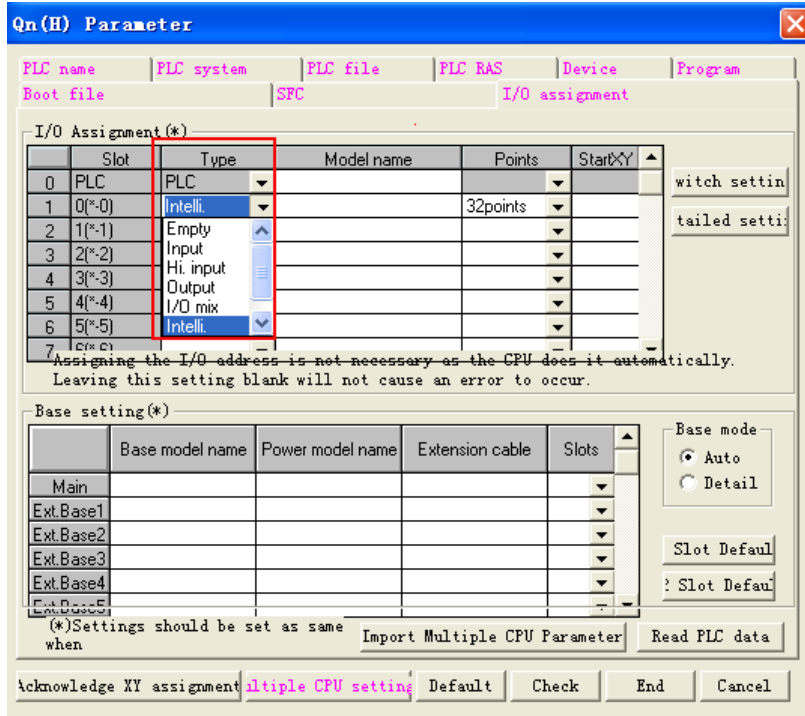

c. Click “switch setting” and set

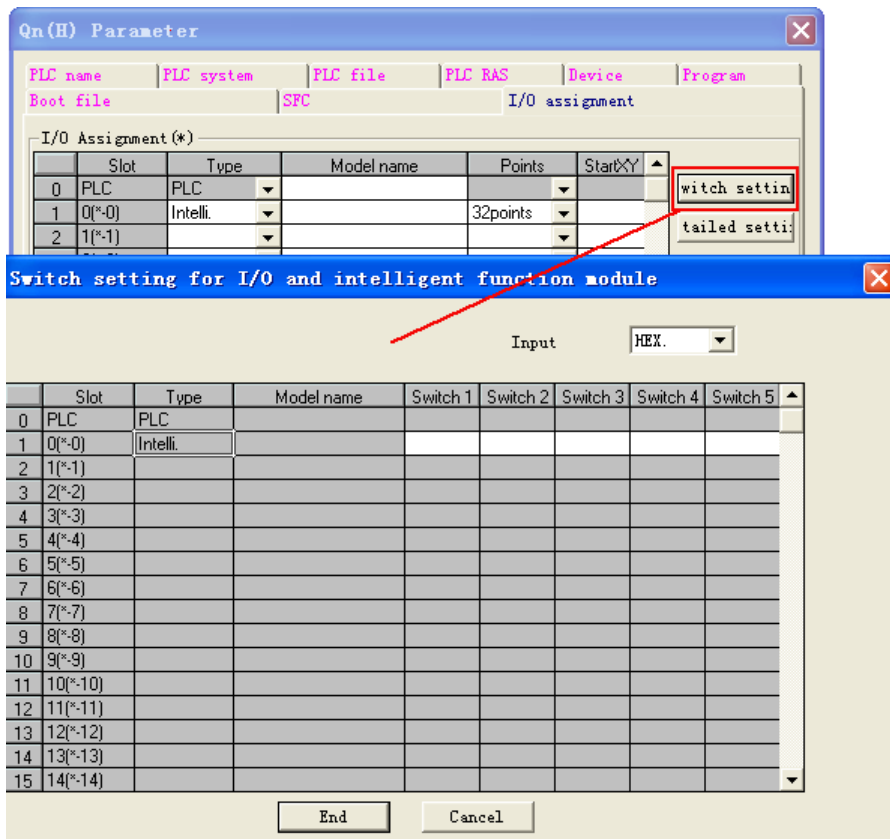

Setting the intelligent function unit switch

switch	content	example
--------	---------	---------

Switch1	CH1:transmission rate, transmission setting		0BEEH																																																		
	<div style="text-align: center;">                     Bit 15 ~ 8 7 ~ 0                      Transmission rate      Transmission setting                 </div> <table border="1" style="display: inline-table; margin-right: 20px;"> <thead> <tr><th>bps</th><th>value</th></tr> </thead> <tbody> <tr><td>4800</td><td>04H</td></tr> <tr><td>9600</td><td>05H</td></tr> <tr><td>19200</td><td>07H</td></tr> <tr><td>38400</td><td>09H</td></tr> <tr><td>57600</td><td>0AH</td></tr> <tr><td>1E+05</td><td>0BH</td></tr> </tbody> </table> <table border="1" style="display: inline-table;"> <thead> <tr><th>Bit</th><th>content</th><th>OFF</th><th>ON</th></tr> </thead> <tbody> <tr><td>0</td><td>Motion Setting</td><td>inching</td><td>cont</td></tr> <tr><td>1</td><td>data bit</td><td>7</td><td>8</td></tr> <tr><td>2</td><td>parity check bit</td><td>N</td><td>Y</td></tr> <tr><td>3</td><td>parity check</td><td>odd</td><td>even</td></tr> <tr><td>4</td><td>stop bit</td><td>1</td><td>2</td></tr> <tr><td>5</td><td>sum check</td><td>N</td><td>Y</td></tr> <tr><td>6</td><td>RUN read-in</td><td>forbid</td><td>allow</td></tr> <tr><td>7</td><td>change</td><td>forbid</td><td>allow</td></tr> </tbody> </table>		bps	value	4800	04H	9600	05H	19200	07H	38400	09H	57600	0AH	1E+05	0BH	Bit	content	OFF	ON	0	Motion Setting	inching	cont	1	data bit	7	8	2	parity check bit	N	Y	3	parity check	odd	even	4	stop bit	1	2	5	sum check	N	Y	6	RUN read-in	forbid	allow	7	change	forbid	allow	115Kbps 8 bit 1 bit even
bps	value																																																				
4800	04H																																																				
9600	05H																																																				
19200	07H																																																				
38400	09H																																																				
57600	0AH																																																				
1E+05	0BH																																																				
Bit	content	OFF	ON																																																		
0	Motion Setting	inching	cont																																																		
1	data bit	7	8																																																		
2	parity check bit	N	Y																																																		
3	parity check	odd	even																																																		
4	stop bit	1	2																																																		
5	sum check	N	Y																																																		
6	RUN read-in	forbid	allow																																																		
7	change	forbid	allow																																																		
Switch2	CH1:communication protocol	MC protocol type5 binary	0005H																																																		
Switch3	CH2:transmission rate, transmission setting (the same as switch 1)		0BEEH																																																		
Switch4	CH2:communication protocol	MC protocol type5 binary	0005H																																																		
Switch5	Station No. setting	0~31	0000H																																																		

If the communication parameters of CH2 485 is 19200/8/odd/1, station:0, set as follows “switch setting” in “PLC parameters” and “I/O assignment”.

Setting Switch	Setting Value	Setup Description
Switch 3	07E6	19200/8/With/Odd/1
Switch 4	0005	Mode = Form 5
Switch 5	0000	Station No. = 0

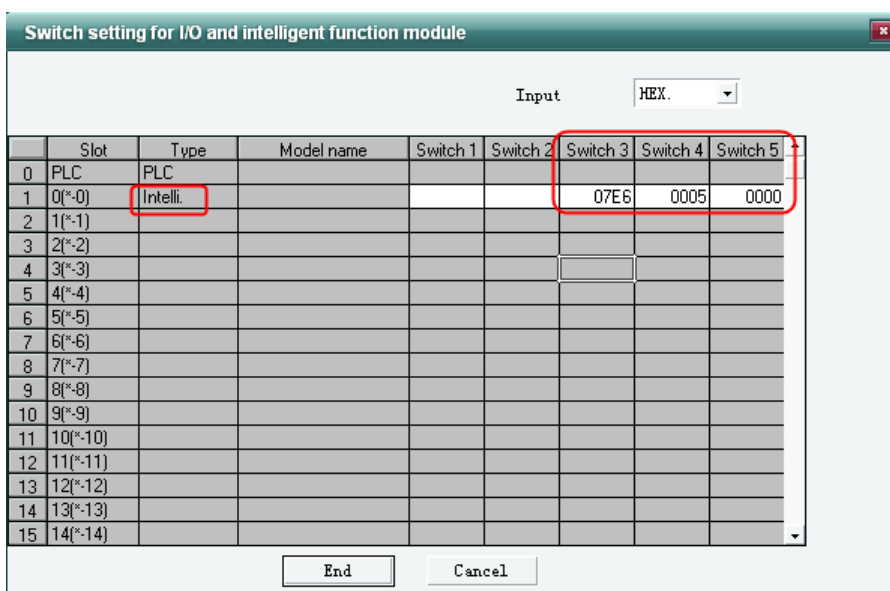

If the communication parameters of CH1 232 is 19200/8/odd/1, station:0, set as follows “switch setting” in “PLC parameters” and “I/O assignment”.

Setting Switch	Setting Value	Setup Description
Switch 1	07E6	19200/8/With/Odd/1
Switch 2	0005	Mode = Form 5
Switch 5	0000	Station No. = 0

**NOTE:** After setting the switches, reset the PLC or turn the power off and then back on again.

### ◎ Network Communication Setting

#### Mitsubishi FX Series Ethernet(TCP Slave) protocol

#### HMI Setting

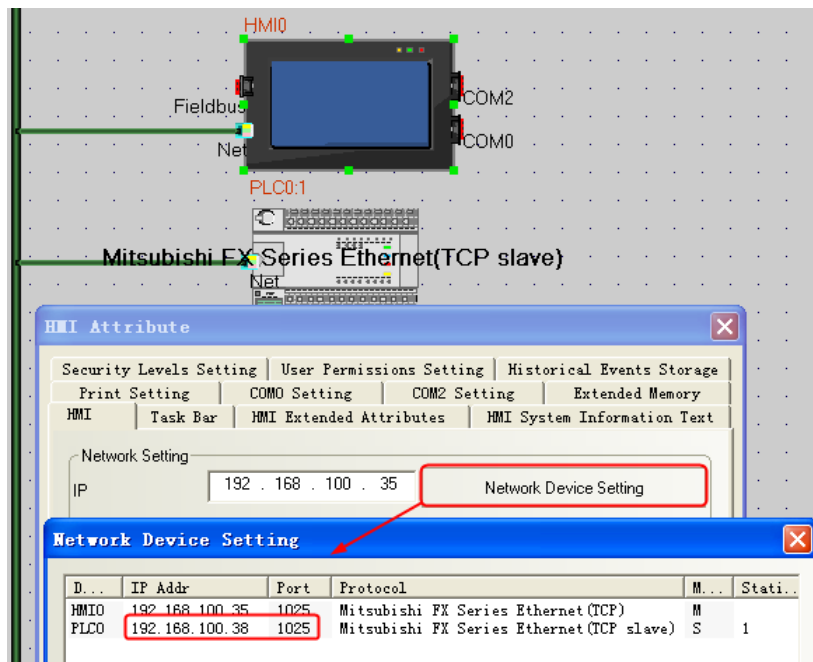

**NOTE:**Data format of PORT number is decimalism

#### PLC Setting

#### FX3GE-24M

1. Double click “PLC Parameters”, select “Built-in Ethernet Port Settings”, the parameters configuration as follow:

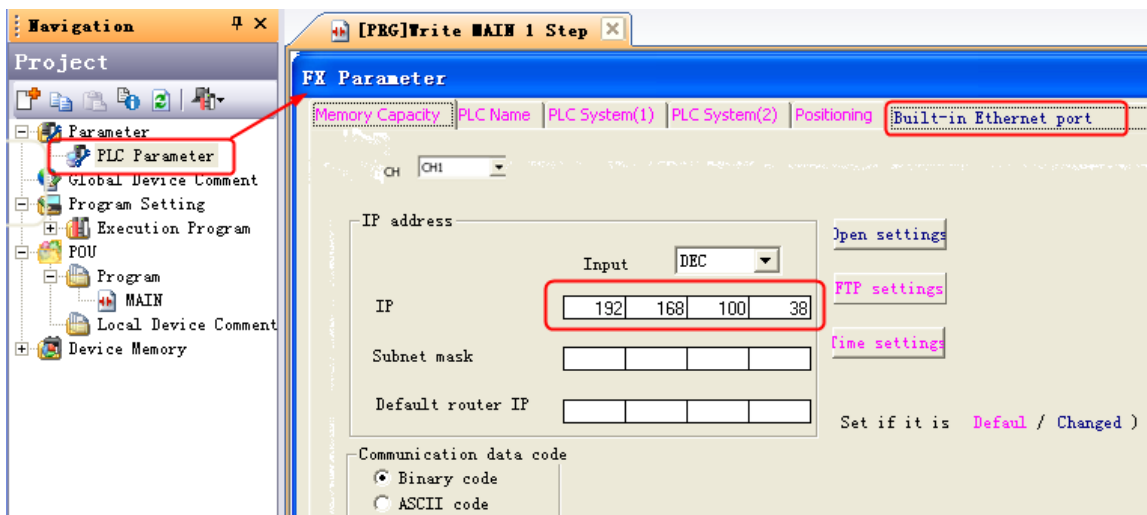

- Click “Open Setting”, the parameters configuration as follow:

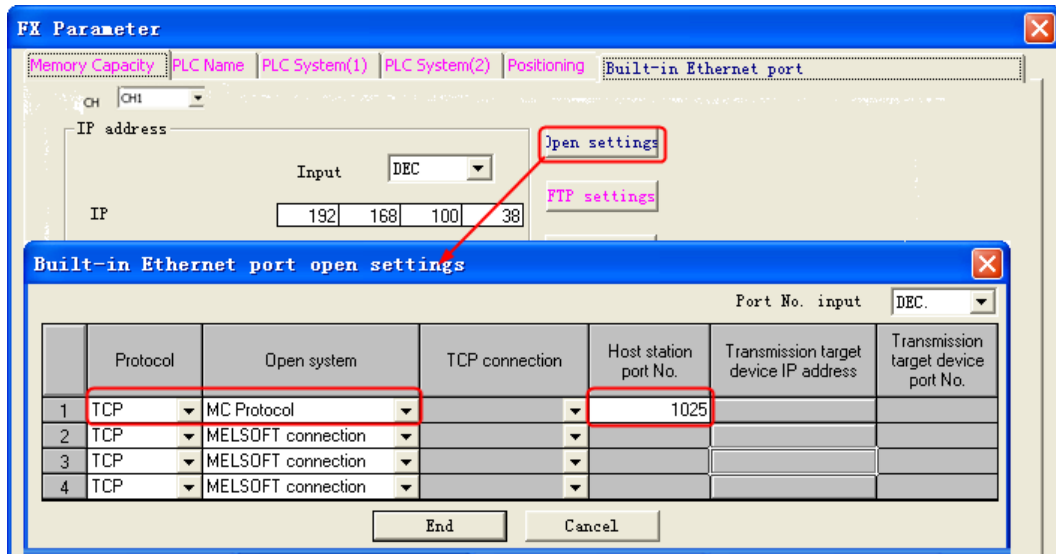

**NOTE: Data format of PORT number is decimalism**

### FX3U-ENET-L

- Open “FX3U-ENET-L Configuration Tool”, the parameters configuration as follow:

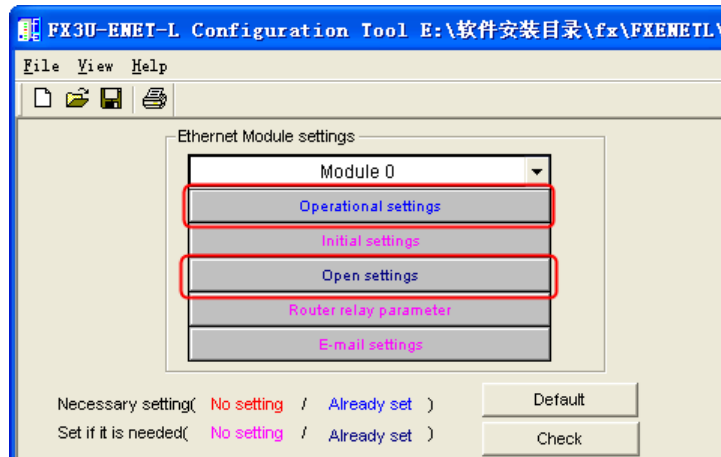

- Click “Operational settings”, the parameters configuration as follow:

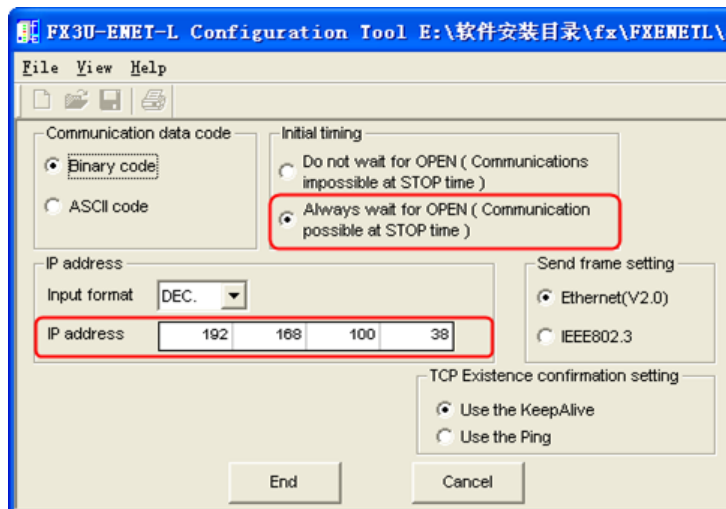

4. Click “Open settings” , the parameters configuration as follow:

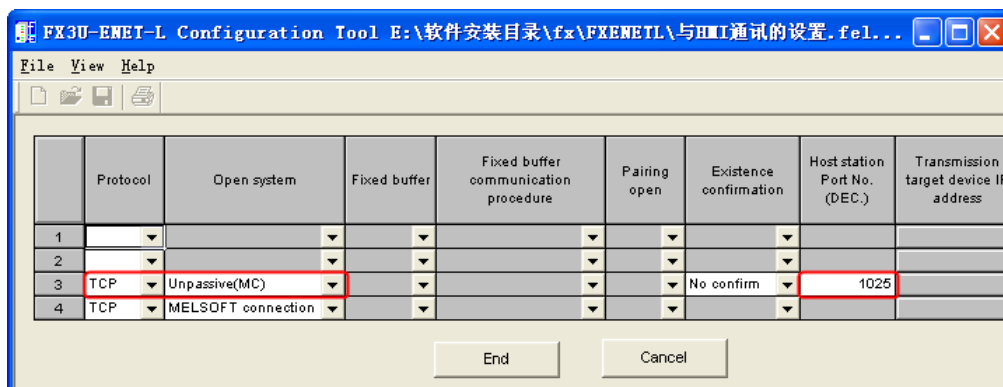

NOTE: Data format of PORT number is decimalism

### Mitsubishi FX5U Series Ethernet(TCP Slave) protocol

#### HMI Setting

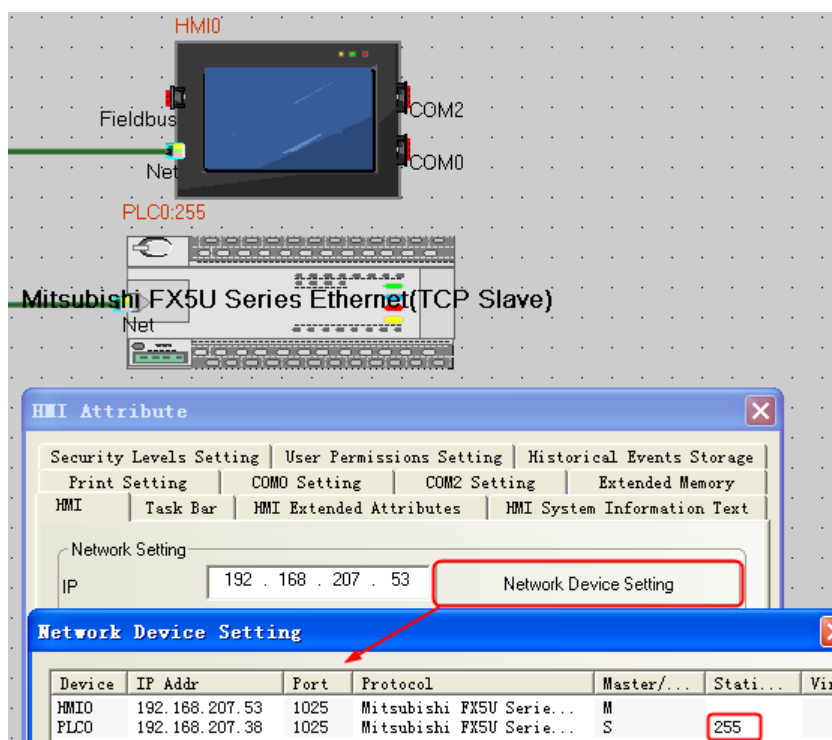

NOTE: 1.Data format of PORT number is decimalism

2.PLC station must be 255

#### PLC Setting

1. Click”Parameter”----“FX5UCPU” ---- “Module Parameter” ----“Ethernet Port”

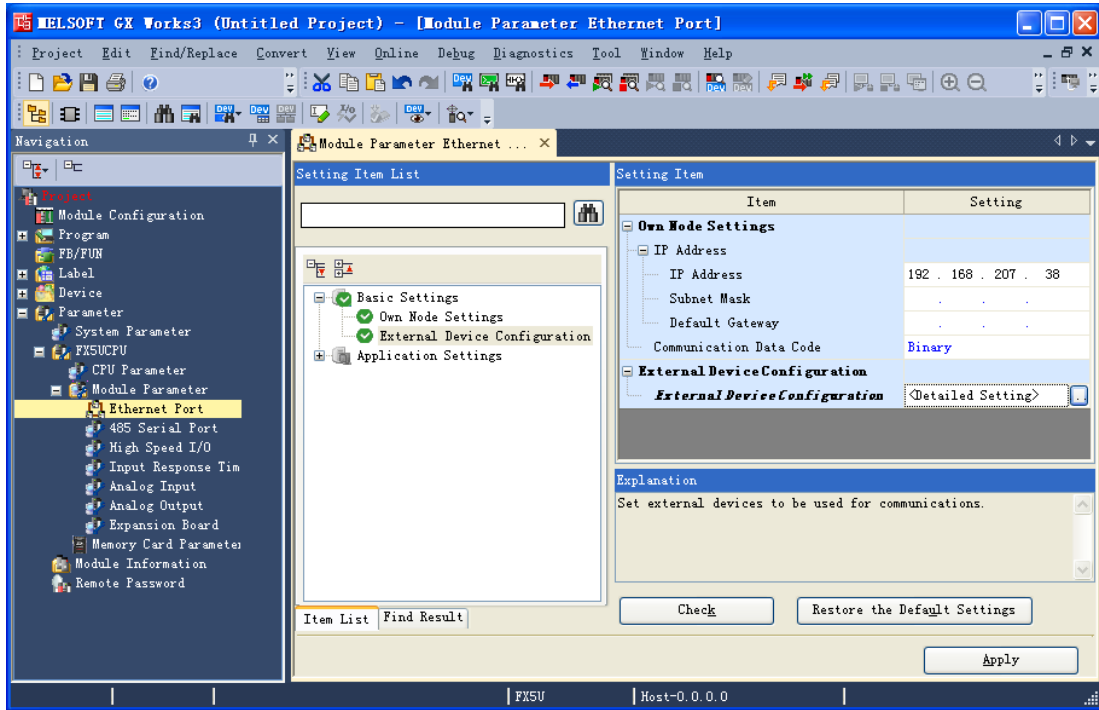

2. In the “Ethernet Port” Setting Item List---“External Device Configuration”,click “Detailed Setting”.
3. Popup the Ethernet Device(General) list, choose “SLMP Connection Module”,and set TCP Protocol, Port No. :1025, then Close with Reflecting the Setting.

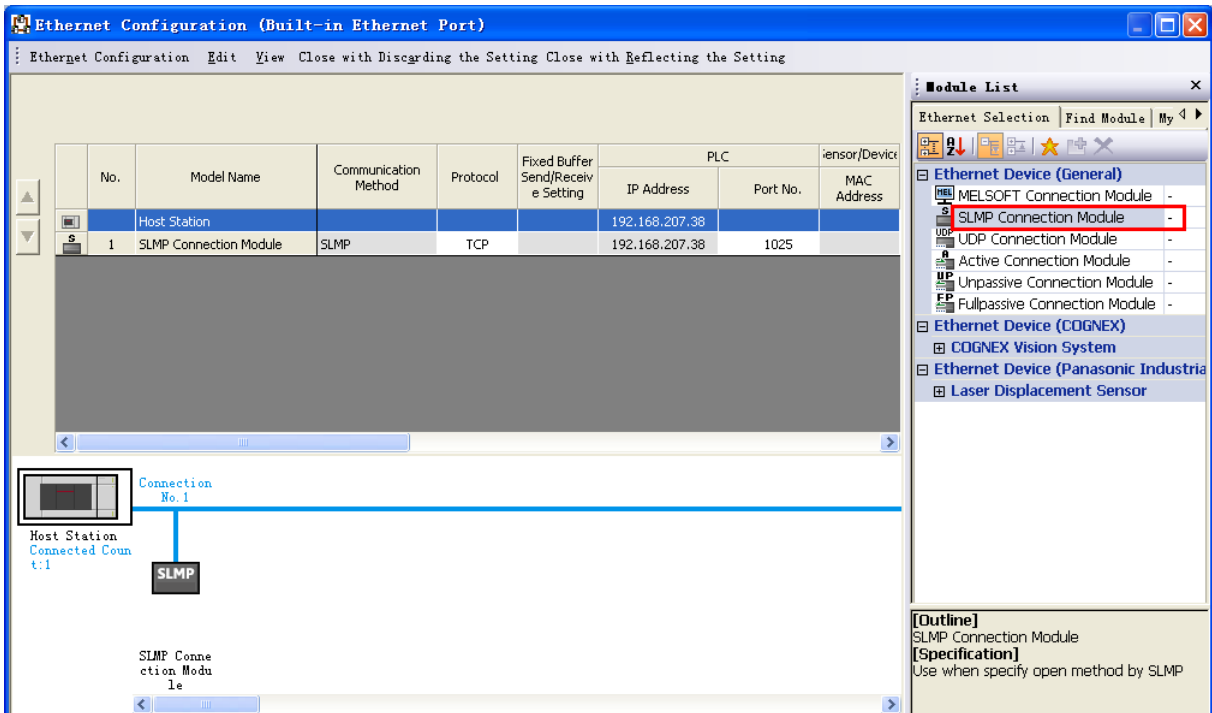

**NOTE:** 1.Data fomart of PORT number is decimalism

4. When connecting multiple HMI, the multiple HMIs cannot be set in the same project.

Example: Two HMIs connect to one plc.

HMI setting:



a. HMI1 setting in the project:

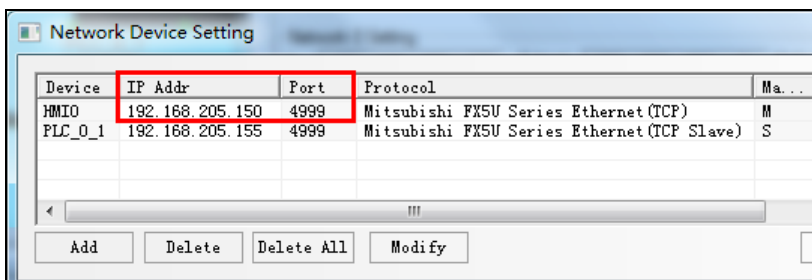

b.HMI2 setting in another project:

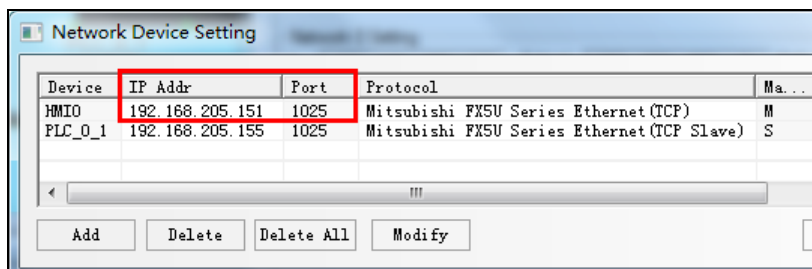

c. Download two projects to two HMIs respectively

PLC setting:

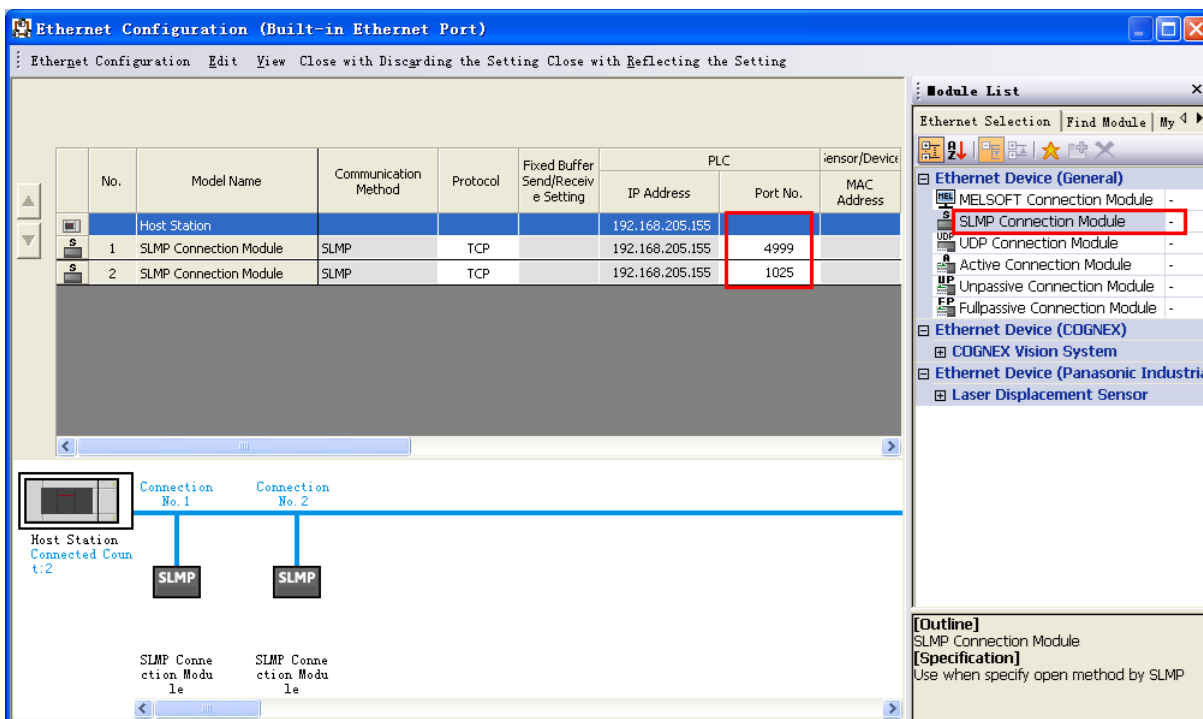

Note: there are requirements for port number on PLC. To connect one device, you need to open a port number. To connect N devices, you need to open N port numbers, and the port number cannot be repeated

### Mitsubishi QJ71E71 EtherNet protocol

#### HMI Setting

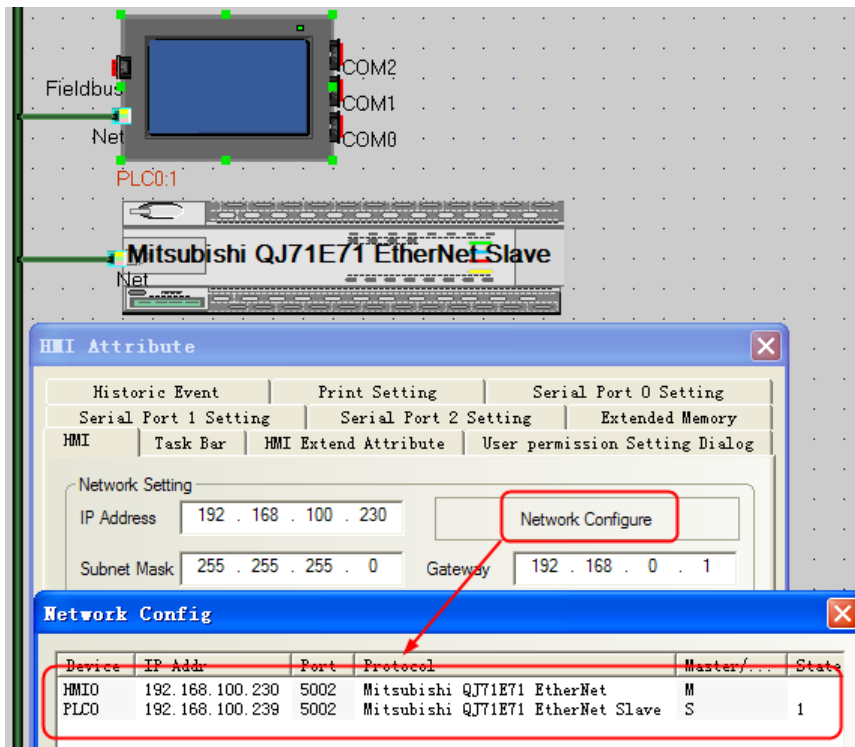

## PLC Setting

### 1. Network parameters

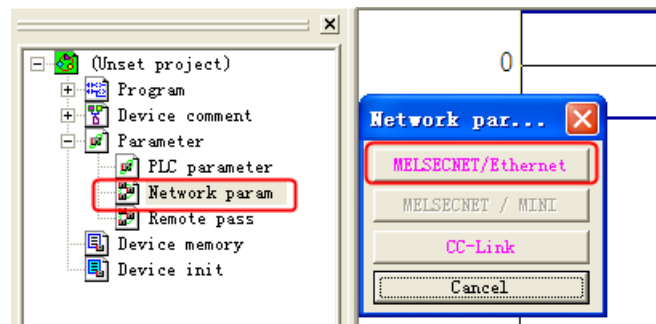

	Module 1	Module 2
Network type	Ethernet	None
Starting I/O No.	0000	
Network No.	1	
Total stations		
Group No.	0	
Station No.	2	
Mode	On line	
	Operational settings	
	Initial settings	
	Open settings	
	Router relay parameter	
	Station No. <-> IP information	
	FTP Parameters	
	E-mail settings	
	Interrupt settings	

[network type] select "Ethernet"; [start I/O] is a hexadecimal number increments & H10, you can select "0"; [network number] range is 1-239, generally set at the network level, only a layer of the network, so set to "1"; [Group number] range is 0-32, select "0"; [station number] range 1-64, 1 occupied by the computer side, can be set to 2-64, the example is set to "2" ; [Mode] Select "online". Next, click

[operation], set the IP address of the dialog box pops up, in part by the network to determine the first three, the fourth part of the free use of the network number. One thing to note is that the figure of [the initial time setting] to choose "Always wait to open" (stop when communication), or Ethernet port is not open external device. Click [end set] button to save the settings.

2. Operational settings

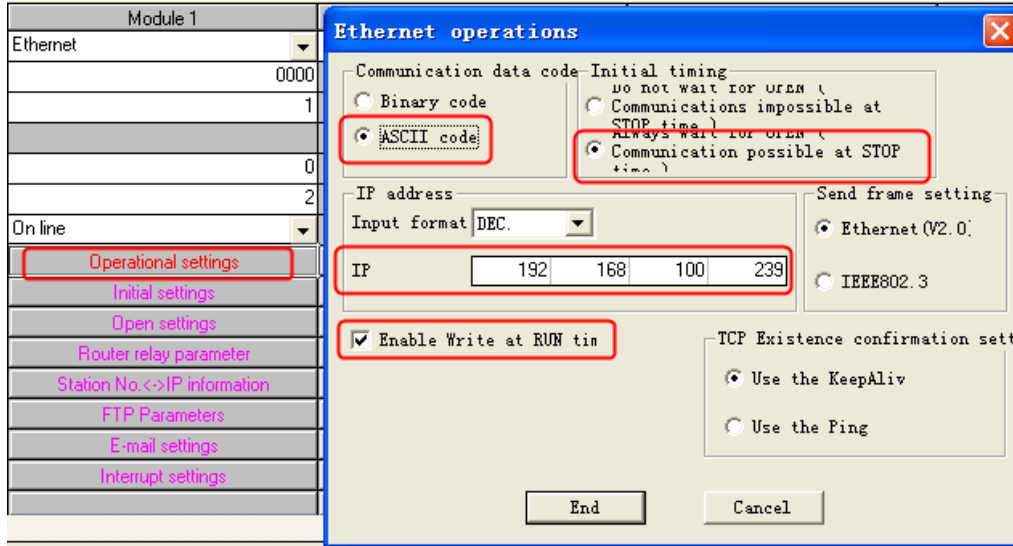

3. Open settings

Multiple HMIs are connected, set in "open Settings", select "TCP" -- "MELSOFT connection", connect N HMIs, and then set N TCP.

	Protocol	Open system	Fixed buffer	Fixed buffer communication procedure	Pairing open	Existence confirmation
1	TCP	MELSOFT connection				
2	TCP	MELSOFT connection				
3	TCP	MELSOFT connection				
4	TCP	MELSOFT connection				
5	TCP	MELSOFT connection				

4. The HMI IP is in the same network segment with PLC.

Note: the port number of the HMI can be ignored.

5. Just write to set the PLC in the main menu selection [online]->"PLC write", the "PLC/network parameters" in the content downloaded to the PLC, the correct execution, the writing on the work of the Ethernet parameters completed.

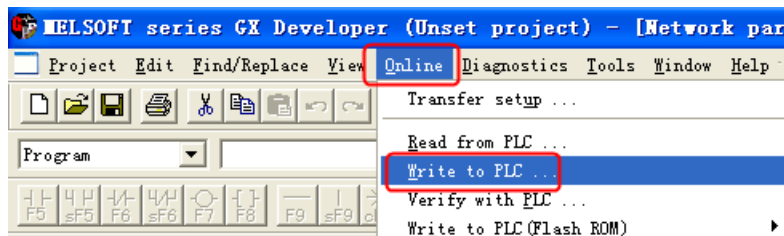

Mitsubishi QnA 3EBin Ethernet(TCP Slave) protocol

L02:

HMI Setting

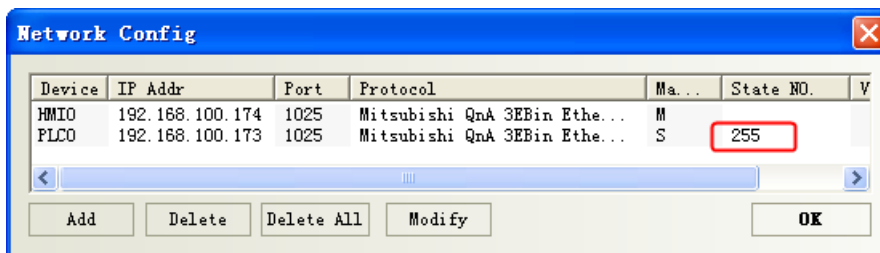
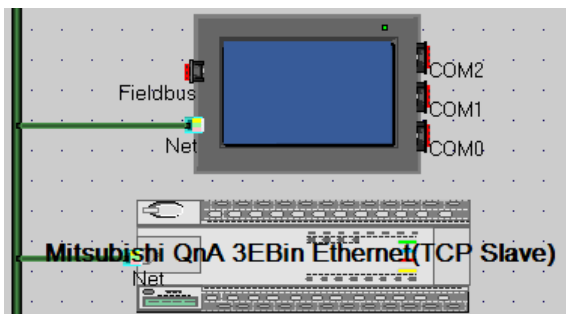

**NOTE:**

1. PLC station number must be 255
2. Data format of Port number is decimalism

**PLC Setting**

Double click “PLC parameters”, select “Built-in Ethernet Port Settings”

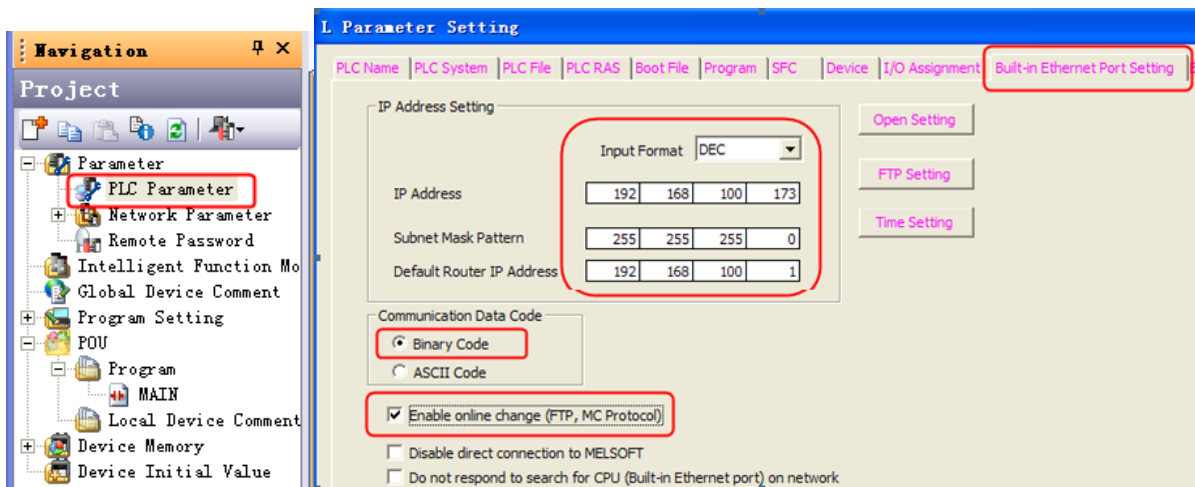

Click “Open Setting”, the parameters configuration as follow:

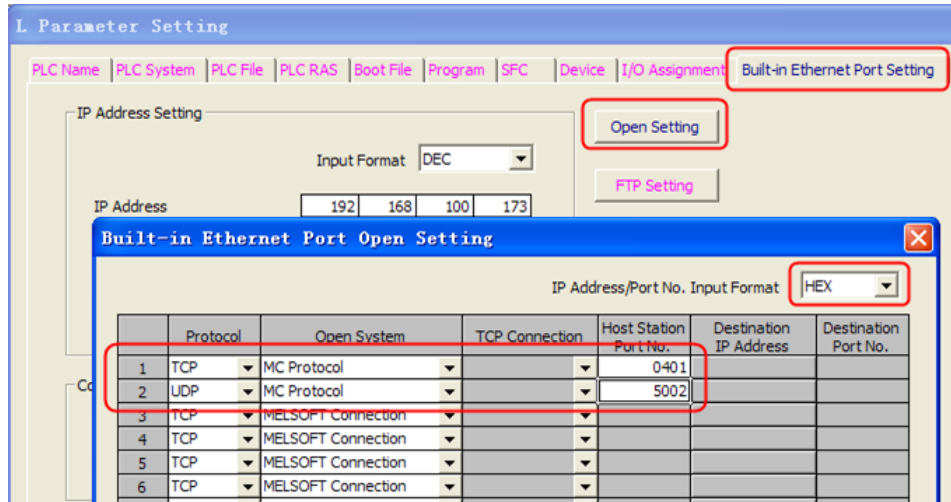

**NOTE:** Host Station Port No. will be set by the selected format.

**Q03UDE CPU :**  
**HMI Setting**

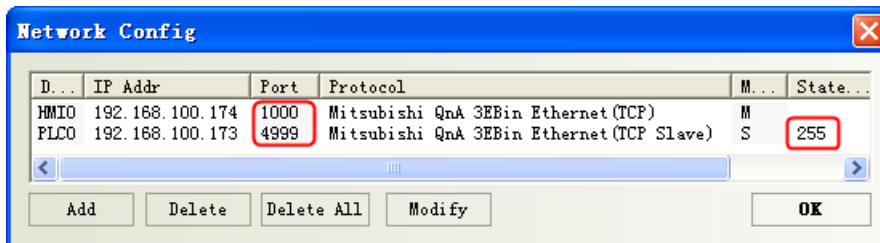
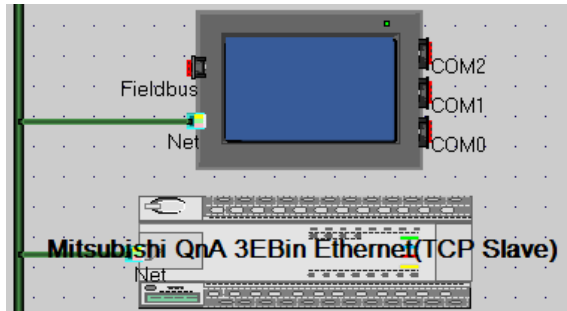

**NOTE:**

1. PLC station number must be 255
2. Data format of Port number is decimalism

**PLC Setting**

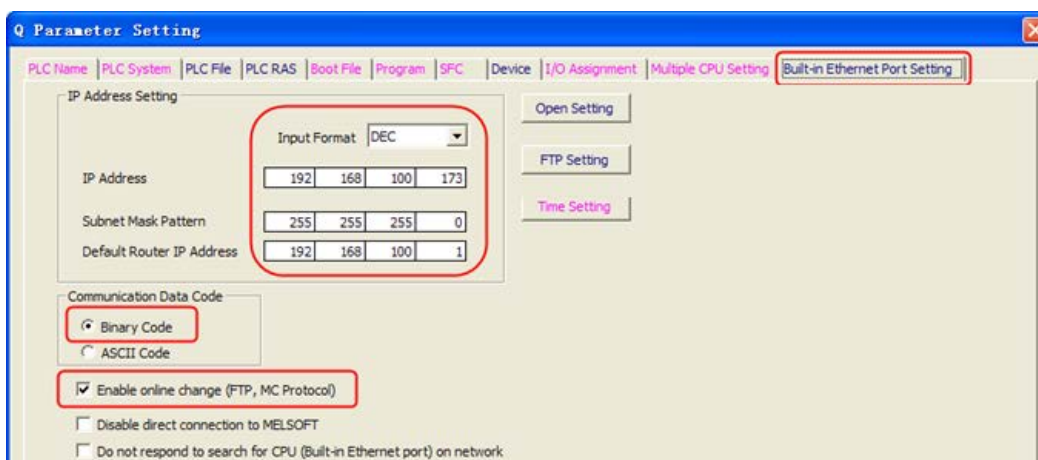

Click "Open Setting", the parameters configuration as follow:

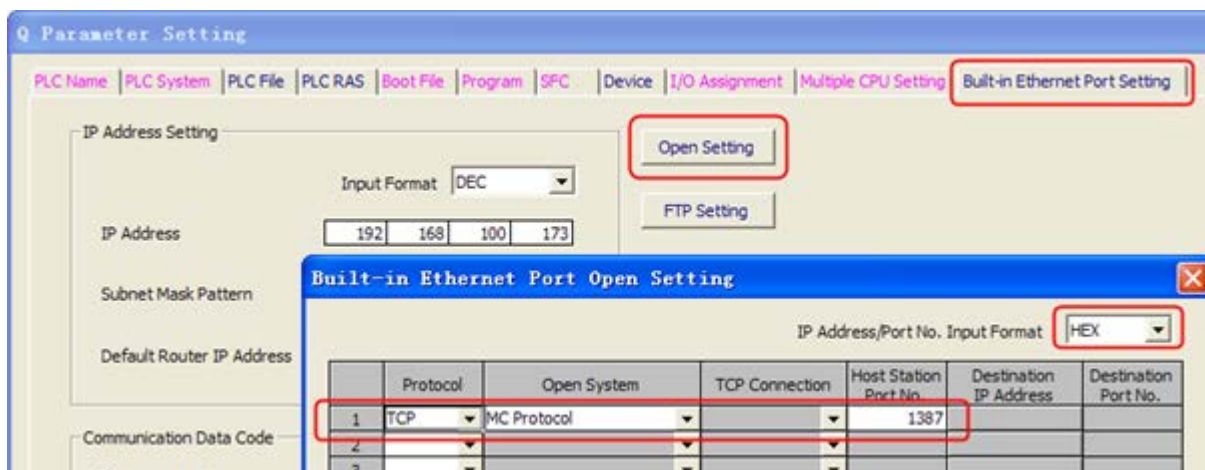

**NOTE:** Host Station Port No. will be set by the selected format.

### © Supported Device

#### FX1S

Device	Bit Address	Word Address	Format	Notes
Input Relay	X 00-764	-----	OOO	
Output Relay	Y 00-764	-----	OOO	

Internal Relay	M 000-7999	-----	DDDD	
Timer Contact	T 00-255	-----	DDD	
Counter Contact	C 00-255	-----	DDD	
Data Contact	D_bit 0.0-9999.F	-----	DDDD.H	
State	S 000-4095	-----	DDDD	
Timer Value	-----	T_word 00-511	DDD	
Counter Value	-----	C_word 00-199	DDD	
Data Register	-----	D_word 000-9999	DDDDD	
Special Data Register	-----	SD_word 8000-9999	DDDD	
Counter Value	-----	C_dword 200-255	DDD	32 bit device

**FX0N/FX1N/2N/3G**

Device	Bit Address	Word Address	Format	Notes
Input Relay	X 000-377	-----	OOO	
Output Relay	Y 000-377	-----	OOO	
Internal Relay	M 0000-3071	-----	DDDD	
Timer Contact	T_bit 000-255	-----	DDD	
Counter Contact	C_bit 000-199	-----	DDD	
Special Internal Relay	SM 8000-8255	-----	DDDD	
State	S 000-999	-----	DDD	
Timer Value	-----	T_word 000-255	DDD	
Counter Value	-----	C_word 000-199	DDD	
Data Register	-----	D 0000-7999	DDDD	
Special Data Register	-----	SD 8000-8255	DDDD	
Counter Value	-----	C_dword 200-255	DDD	32 bit device
R	-----	R 0-32767	DDDDD	

**FX2N-10GM/20GM**

Device	Bit Address	Word Address	Format	Notes
Input Relay	X 00-571	-----	OO	*1
Output Relay	Y 00-571	-----	OO	*1
Internal Relay	M 000-9175	-----	DDD	*1
Special Internal Relay	SM9000-9999	-----	DDDD	*1
Data Register	-----	D 0-9313	DDDD	*2
Special Data Register	-----	SD 9000-9999	DDDD	*2
Special Data Register	-----	FD 4000-4550	DDDD	*2

Current Position(System)	-----	CP_unit 0-1	D	
Current Position(Pulse)	-----	CP_puls 0-1	D	

**NOTE:**

\*1 Don't support batch

\*2 Support batch

**FX3UC**

Device	Bit Address	Word Address	Format	Notes
Input Relay	X000-764	-----	OOO	
Output Relay	Y000-764	-----	OOO	
Timer Contact	T_bit 000-511	-----	DDD	
Counter Contact	C_bit 000-255	-----	DDD	
Data Contact	D_bit0.0-7999.F	-----	DDDD.H	
State	S0000-4095	-----	DDDD	
Internal Relay	M0000-7999	-----	DDDD	
Special Internal Relay	SM8000-9999	-----	DDDD	
Timer Value	-----	T_word 000-511	DDD	
Counter Value	-----	C_word 000-199	DDD	
Data Register	-----	D_word 0-7999	DDDDD	
Extension Register	-----	R0000-32767	DDDDD	
Special Data Register	-----	SD8000-9999	DDDD	
Counter Value	-----	C_dword200-255	DDD	32 bit device

**FX Series Ethernet**

Device	Bit Address	Word Address	Format	Notes
State	S 0-4095	-----	DDDD	
Data Contact	D_bit0.0-7999.F	-----	DDDD.H	
Special Internal Relay	SM8000-8511	-----	DDDD	
Counter Contact	C_bit0-255	-----	DDDD	
Timer Contact	T_bit0-511	-----	DDDD	
Internal Relay	M 0-7679	-----	DDDD	
Output Relay	Y 0-377	-----	DDDD	
Input Relay	X 0-377	-----	DDDD	
Extension Register	-----	R 0-32767	DDDDD	
Special Data Register	-----	SD 8000-8511	DDDD	
Data Register	-----	D_word0-7999	DDDD	
Timer Value	-----	T_word0-511	DDD	
Counter Value	-----	C_word0-199	DDD	



Counter Value	-----	C_dword200-255	DDD	
---------------	-------	----------------	-----	--

**FX5U**

Device	Bit Address	Word Address	Format	
Retentive TimerValve (contact)	SS 0-15	-----	DD	
Counter Valve (contact)	CS 0-255	-----	DDD	
Counter Valve (coil)	CC 0-255	-----	DDD	
Timer Valve (contact)	TS 0-511	-----	DDD	
Retentive TimerValve (coil)	SC 0-15	-----	DD	
Timer Valve (coil)	TC 0-511	-----	DDD	
	D_bit0.0-7999.0	-----	DDDD.H	
Specia Link Relay	SB 0-FF	-----	HH	
Link Relay	B 0-FF	-----	HH	
State Relay	S 0-4095	-----	DDDD	
Annunciator Relay	F 0-127	-----	DDD	
Latch relay	L 0-7679	-----	DDDD	
Specia Internal Relay	SM 0-9999	-----	DDDD	
Internal Relay	M 0-7679	-----	DDDD	
Output Relay	Y 0-1777	-----	OOOO	
Input Relay	X 0-1777	-----	OOOO	
Long Counter Valve (contact)	LCS 0-63	-----	DD	
Long Counter Valve (coil)	LCC 0-63	-----	DD	
16 Bit Index Register	-----	Z 0-19	DD	
Retentive TimerValve	-----	SN 0-15	DD	
Counter Valve	-----	CN 0--255	DDD	
Timer Valve	-----	TN 0-511	DDD	
Specia Link Register	-----	SW 0-1FF	HHH	
Link Register	-----	W 0-1FF	HHH	
File Register	-----	R 0-32767	DDDDD	
Specia Date Register	-----	SD 0-11999	DDDDD	
Date Register		D 0-7999	DDDD	
32 Bit Index Register		LZ 0-1	D	
Long Counter Valve		LCN 0-63	DD	Double

**FX5u Series Ethernet**

Device	Bit Address	Word Address	Format	Notes
State	S 0-4095	-----	DDDD	
Special Link Relay	SB0-FF	-----	HH	

Link Relay	B0-FF	-----	HH	
Annunciator	F0-127	-----	DDD	
Latch Relay	LO-7679	-----	DDDD	
Special Internal Relay	SM0-9999	-----	DDDD	
Internal Relay	M0-7679	-----	DDDD	
Output Relay	Y 0-1777	-----	OOOO	
Input Relay	X 0-1777	-----	OOOO	
	D_bit 0.0-7999.0	-----	DDDD.H	
File Register	-----	R 0-32767	DDDDD	
Counter Value	-----	CN0-255	DDD	
Retentive Timer Value	-----	SN0-15	DD	
Timer Value	-----	TN0-511	DDD	
Special Link Register	-----	SW0-1FF	HHH	
Link Register	-----	W0-1FFF	HHH	
Special Data Register	-----	SD0-11999	DDDDD	
Data Register	-----	D0-7999	DDDD	

**Q00jCPU**

Device	Bit Address	Word Address	Format	Notes
Counter Coil	CC0-1023	-----	DDDD	
Counter Contact	CS0-1023	-----	DDDD	
Timer Coil	TC0-2047	-----	DDDD	
Timer Contact	TS0-2047	-----	DDDD	
Special Link Relay	SB000-7FFF	-----	HHHH	
Link Relay	B0000-7FFF	-----	HHHH	
Step Relay	S0000-1FFF	-----	HHHH	
Edge Relay	V0000-32767	-----	DDDDD	
Annunciator	F0000-32767	-----	DDDDD	
Latch Relay	L0000-32767	-----	DDDDD	
Special Internal Relay	SM0000-2047	-----	DDDD	
Internal Relay	M0000-32767	-----	DDDDD	
Output Relay	Y0000-1FFF	-----	HHHH	
Input Relay	X0000-1FFF	-----	HHHH	
File Register	-----	R000-32767	DDDDD	
Special Link Register	-----	SW0-7FF	HHH	
Link Register	-----	W000-291F	HHHH	
Special Data Register	-----	SD0-2047	DDDD	
Data Register	-----	D0-25983	DDDDD	

Counter Value	-----	CNO-23087	DDDDD	
Retentive Timer Value	-----	SN0-2047	DDDD	
Timer Value	-----	TN0-23087	DDDDD	

**Melsec Q**

Device	Bit Address	Word Address	Format	Notes
Direct output	DY 0-7FF		HHHH	
Direct input	DX 0-7FF		HHHH	
Step Relay	S 0-2047	-----	DDDD	
Special Link Relay	SB 0-7FFF		HHHH	
Counter Coil	CC 0-511	-----	DDDD	
Counter Contact	CS 0-511	-----	DDDD	
Step Coil	SC 0-511	-----	DDDD	
Step Contact	SS 0-511	-----	DDDD	
Timer Coil	TC 0-511	-----	DDDD	
Timer Contact	TS 0-511	-----	DDDD	
Link Relay	B 0-7FF		HHHH	
Edge Relay	V 0-1023	-----	DDDD	
Annunciator	F 0-1023	-----	DDDD	
Latch Relay	L 0-2047	-----	DDDD	
Internal Relay	M 0-8191	-----	DDDD	
Output Relay	Y 0-7FF	-----	HHHH	
Input Relay	X 0-7FF	-----	HHHH	
File Register	-----	ZR 0-65535	DDDDDD	
File Register	-----	R 0-32767	DDDD	
Index Register	-----	Z 0-9	DD	
Counter Value	-----	CN 0-511	DDDD	
Retentive Timer Value		SN 0-511	DDDD	
Timer Value	-----	TN 0-511	DDDD	
Special Link Register	-----	SW 0-3FF	HHH	
Link Register	-----	W 0-1FFF	HHHH	
Special Data Register	-----	SD 0-2047	DDDD	
Data Register	-----	D 0-11135	DDDDD	

**Q Series CPU port**

Device	Bit Address	Word Address	Format
Special Link Relay	SB 00000- 7FFF	-----	HHHH
Link Relay	B 00000- 7FFF	-----	HHHH

Step Relay	S 0000-8191	-----	DDDD
Edge relay	V 00000-32767	-----	DDDDD
Annunciator	F 00000-32767	-----	DDDDD
Latch relay	L 00000-32767	-----	DDDDD
Special Internal Relay	SM 0000-2047	-----	DDDD
Internal Relay	M 00000-32767	-----	DDDDD
Output Relay	Y 0000-1FFF	-----	HHHH
Input Relay	X 0000-1FFF	-----	HHHH
Index Register	-----	Z 00-19	DD
File Register	-----	ZR 0-16777215	DDDDD
Link Register	-----	W 00000- 291F	HHHH
Timer Value	-----	TN 00000-23087	DDDDD
Counter Value	-----	CN 00000-23087	DDDDD
Retentive Timer Value	-----	SN 00000-23087	DDDDD
File Register	-----	R 00000-65535	DDDDD
Special Link Register	-----	SW 0000- 7FF	HHH
Data Register	-----	D 00000-25983	DDDDD
Special Data Register	-----	SD 0000-2047	DDDD

#### Q\_QnA(link port)

Device	Bit Address	Word Address	Format
Special Link Relay	SB000-7FFF	-----	HHHH
Step Relay	S 000-8191	-----	DDDD
Link Relay	B0000-7FFF	-----	HHHH
Edge Relay	V0000-32767	-----	DDDDD
Annunciator	F0000-32767	-----	DDDDD
Latch Relay	L0000-32767	-----	DDDDD
Special Internal Relay	SM0000-2047	-----	DDDD
Internal Relay	M0000-32767	-----	DDDDD
Output Relay	Y0000-1FFF	-----	HHHH
Input Relay	X0000-1FFF	-----	HHHH
Index Register	-----	Z 0-19	DD
Link Register	-----	W0000-291F	HHHH
Timer Value	-----	TN0-23087	DDDDD
Retentive Timer Value	-----	SN0-23087	DDDDD
Counter Value	-----	CN0-23087	DDDDD
File Register(Block switching is not necessary)	-----	ZR00000-65535	DDDDD
File Register	-----	R00000-32767	DDDDD

Special Link Register	-----	SW000-7FF	HHH
Data Register	-----	D00000-25983	DDDDD
Special Data Register	-----	SD0000-2047	DDDD

**Q06**

Device	Bit Address	Word Address	Format
Special Link Relay	SB 0000- 7FFF	-----	HHHH
Link Relay	B 0000- 1FFF	-----	HHHH
Edge relay	V 00000-2047	-----	DDDDD
Annunciator	F 00000-2047	-----	DDDDD
Latch relay	L 00000-8191	-----	DDDDD
Special Internal Relay	SM 0000-2047	-----	DDDD
Internal Relay	M 00000-20480	-----	DDDDD
Output Relay	Y 0000-1FFF	-----	HHHH
Input Relay	X 0000-1FFF	-----	HHHH
S	S0-8191	-----	DDDD
Link Register	-----	W 00000- 27FF	HHHH
Timer Value	-----	TN 00000-8191	DDDDD
	-----	SN 0-4095	DDDD
Counter Value	-----	CN 00000-8191	DDDDD
File Register	-----	R 00000-32767	DDDDD
Special Link Register	-----	SW 0000- 7FF	HHH
Data Register	-----	D 00000-15359	DDDDD
Special Data Register	-----	SD 0000-2047	DDDD
	-----	TS 0-4095	DDDD
	-----	TC 0-4095	DDDD
	-----	SS 0-4095	DDDD
	-----	SC 0-4095	DDDD
	-----	CS 0-4095	DDDD
	-----	CC 0-4095	DDDD

**Mitsubishi QJ71E71 EtherNet Slave**

Device	Bit Address	Word Address	Format
Step Relay	S 000-8191	-----	DDDD
Special Link Relay	SB 000-7FFF	-----	HHHH
Counter Coil	CC 0-23087	-----	DDDDD
Counter Contact	CS 0-23087	-----	DDDDD
Step Coil	SC 0-23087	-----	DDDDD

Step Contact	SS 0-23087	-----	DDDDD
Timer Coil	TC 0-23087	-----	DDDDD
Timer Contact	TS 0-23087	-----	DDDDD
Link Relay	B 0000-7FFF	-----	HHHH
Edge Relay	V 0-32767	-----	DDDDD
Annunciator	F 0-32767	-----	DDDDD
Latch Relay	L 0-32767	-----	DDDDD
Special Internal Relay	SM 0-2047	-----	DDDD
Internal Relay	M 0-32767	-----	DDDD
Output Relay	Y 0-1FFF	-----	HHHH
Input Relay	X 0-1FFF	-----	HHHH
Link Register	-----	W 0-291F	HHHH
Timer Value	-----	TN 0-23087	DDDD
Counter Value	-----	CN 0-23087	DDDDD
Retentive Timer Value	-----	SN 0-23087	DDDDD
File Register	-----	R 0-32767	DDDDD
File Register(Block switching is not necessary)	-----	ZR 0-1042431	DDDDDDD
Special Link Register	-----	SW 0-7FF	HHH
Data Register	-----	D 0-25983	DDDDD
Special Data Register	-----	SD 0-2047	DDDD

#### Mitsubishi QnA 3EBin Ethernet(TCP Slave)

Device	Bit Address	Word Address	Format	Notes
Direct output	DY 0-1FFF		HHHH	
Direct input	DX 0-1FFF		HHHH	
Step Relay	S 0-8191	-----	DDDD	
Special Link Relay	SB 0-7FF	SB 0-1FFF	HHHH	
Counter Coil	CC 0-1023	-----	DDDD	
Counter Contact	CS 0-1023	-----	DDDD	
Step Coil	SC 0-2047	-----	DDDD	
Step Contact	SS 0-2047	-----	DDDD	
Timer Coil	TC 0-2047	-----	DDDD	
Timer Contact	TS 0-2047	-----	DDDD	
Link Relay	B 0-1FFF	B 0-1FFF	HHHH	
Edge Relay	V 0-2047	-----	DDDD	
Annunciator	F 0-2047	-----	DDDD	
Latch Relay	L 0-8191	-----	DDDD	
Special Internal Relay	SM 0-2047	-----	DDDD	

Internal Relay	M 0-8191	-----	DDDD	
Output Relay	Y 0-1FFF	Y 0-1FFF	HHHH	
Input Relay	X 0-1FFF	X 0-1FFF	HHHH	
File Register	-----	ZR 0-16777215	DDDDDD	
File Register	-----	R 0-32767	DDDD	
Index Register	-----	Z 0-19	DD	
Counter Value	-----	CN 0-1023	DDDD	
Retentive Timer Value		SN 0-2047	DDDD	
Timer Value	-----	TN 0-2047	DDDD	
Special Link Register	-----	SW 0-7FF	HHH	
Link Register		W 0-1FFF	HHHH	
Special Data Register	-----	SD 0-2047	DDDD	
Data Register	-----	D 0-45055	DDDD	

**Q03UDE**

Device	Bit Address	Word Address	Format	Notes
Direct output	DY 0-1FFF		HHHH	
Direct input	DX 0-1FFF		HHHH	
Step Relay	S 0-8191	-----	DDDD	
Special Link Relay	SB 0-7FF	SB 0-7F0	HHHH	
Counter Coil	CC 0-1023	-----	DDDD	
Counter Contact	CS 0-1023	-----	DDDD	
Step Coil	SC 0-2047	-----	DDDD	
Step Contact	SS 0-2047	-----	DDDD	
Timer Coil	TC 0-2047	-----	DDDD	
Timer Contact	TS 0-2047	-----	DDDD	
Link Relay	B 0-1FFF	B 0-1FF0	HHHH	
Edge Relay	V 0-2047	-----	DDDD	
Annunciator	F 0-2047	-----	DDDD	
Latch Relay	L 0-8191	-----	DDDD	
Special Internal Relay	SM 0-2047	-----	DDDD	
Internal Relay	M 0-8191	-----	DDDD	
Output Relay	Y 0-1FFF	Y 0-1FF0	HHHH	
Input Relay	X 0-1FFF	X 0-1FF0	HHHH	
File Register	-----	ZR 0-32767	DDDDDD	
File Register	-----	R 0-32767	DDDD	
Index Register	-----	Z 0-19	DD	
Counter Value	-----	CN 0-1023	DDDD	

Retentive Timer Value	-----	SN 0-2047	DDDD	
Timer Value	-----	TN 0-2047	DDDD	
Special Link Register	-----	SW 0-7FF	HHH	
Link Register	-----	W 0-1FFF	HHHH	
Special Data Register	-----	SD 0-2047	DDDD	
Data Register	-----	D 0-12287	DDDDD	

## ◎ Cable Diagram

### FX Series RS232 Cable

#### 1. CPU port communication

Please use the FX series SC - 09 serial programming cable communication, can also be made simple programming cable

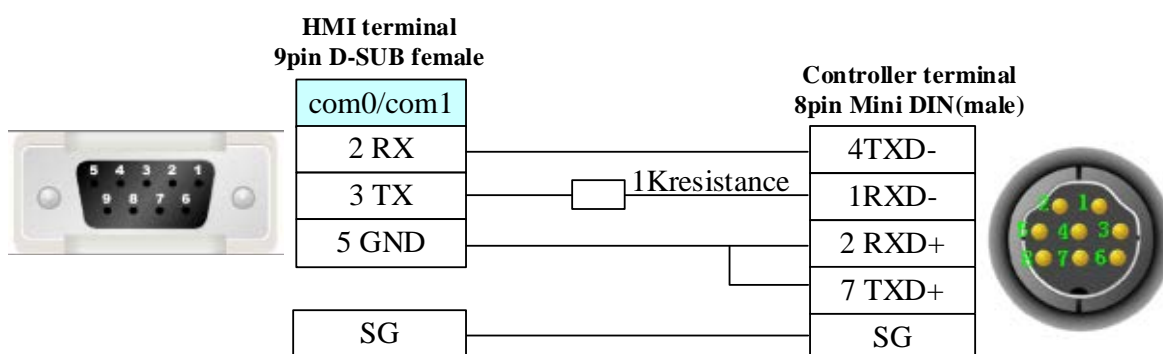

#### 2. FX□□-232-BD/ADP communication

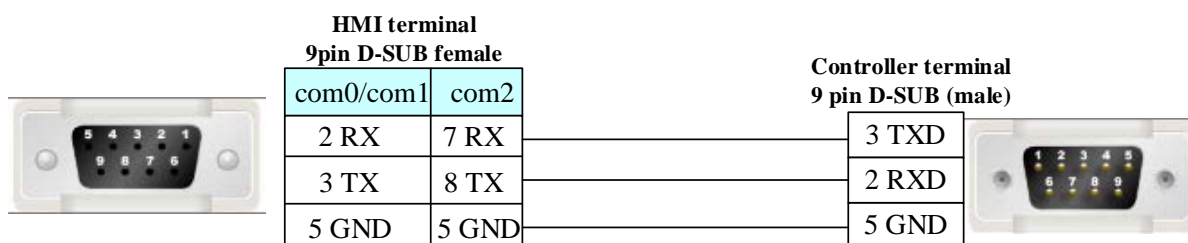

### FX Series RS422 Cable

#### 1. CPU port / FX□□-422-BD communication

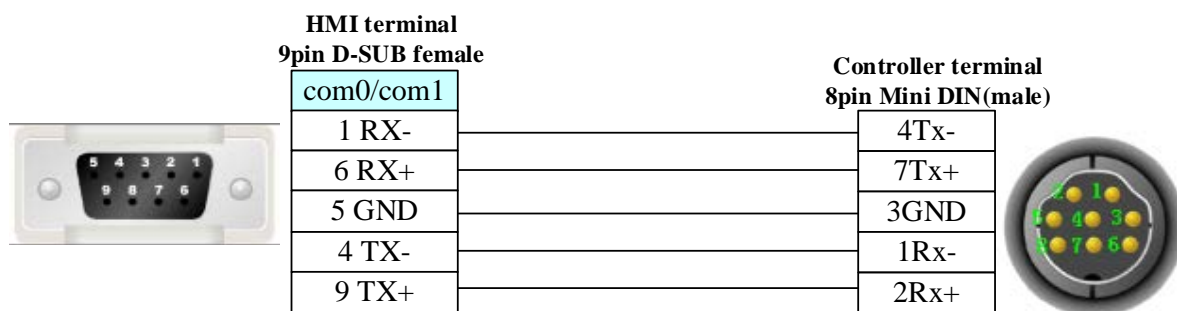

#### 2. FX□□-485-BD communication



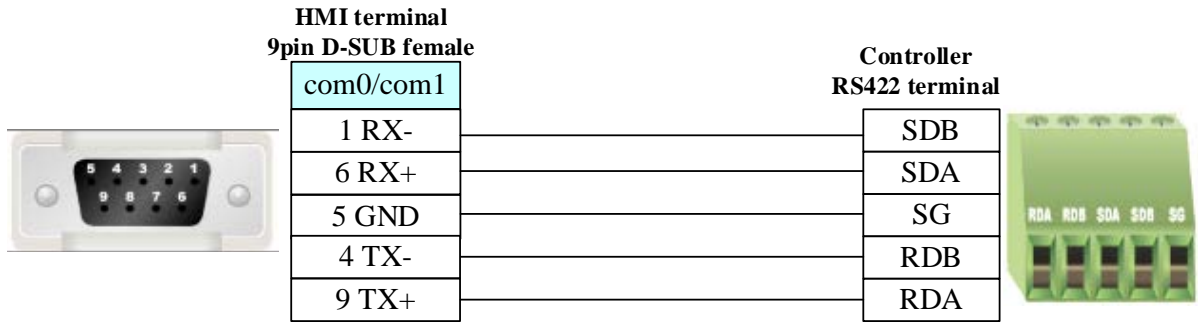

### Q Series RS232 Cable

#### 1. CPU port communication

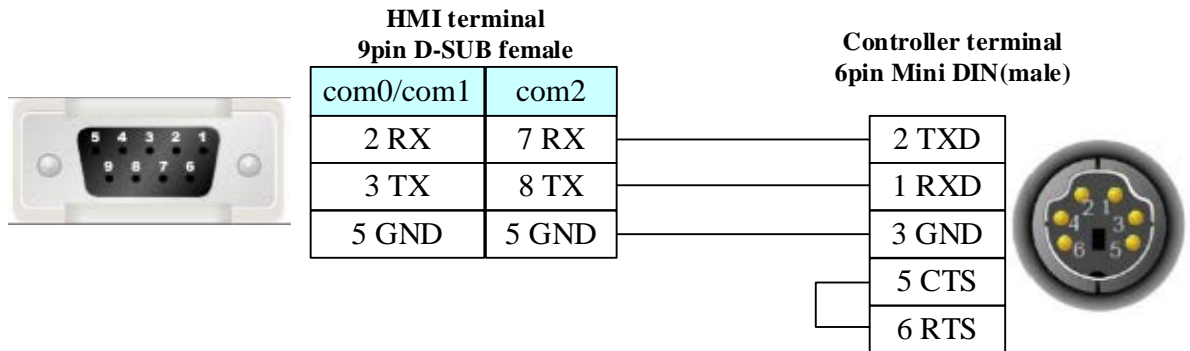

#### 2. C24 module communication

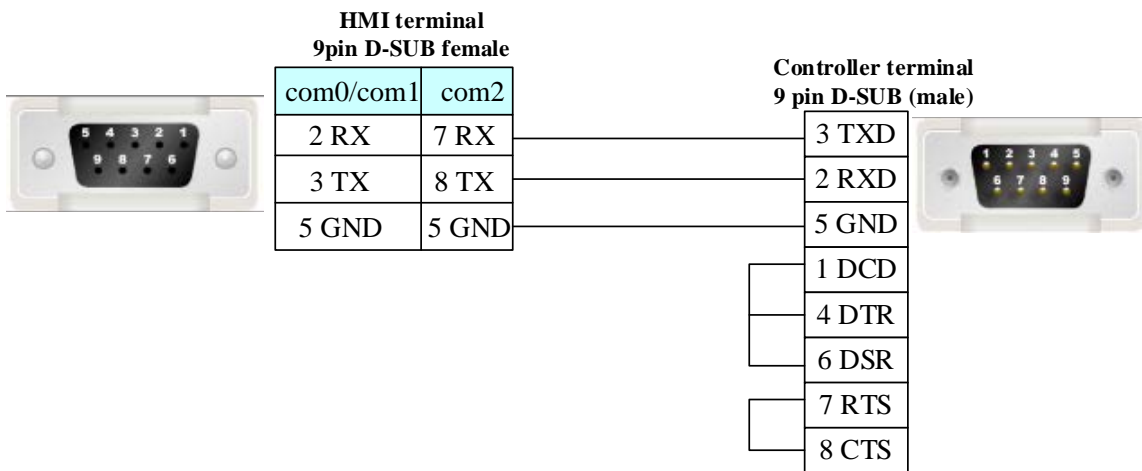

### Q Series RS485/422 Cable

#### C24 module communication

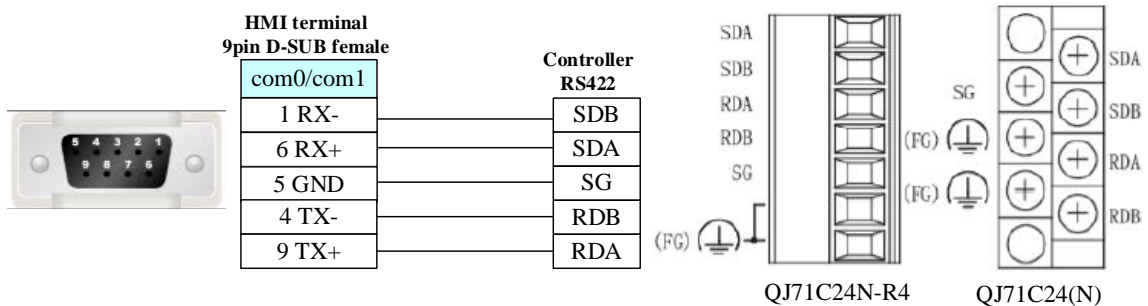

## Ethernet communication protocol cable

Cross-connection or crossover network cable can be used as communication cable via the hub

Refer to [3.3 Download by Network Ethernet](#) for method of making connection cable.

## 4.55 MKS controller

### Serial Communication

Series	CPU	Link Module	Driver
BY125	BY125	RS232 on the CPU unit	MKS

### System configuration

Series	CPU	Link Module	COMM Type	Parameter	Cable
BY125	BY125	RS232 on the CPU unit	RS232	<a href="#">Setting</a>	<a href="#">Your owner cable</a>

### Communication Setting

**Default communication: 9600, 7, even, 1; station: 11**

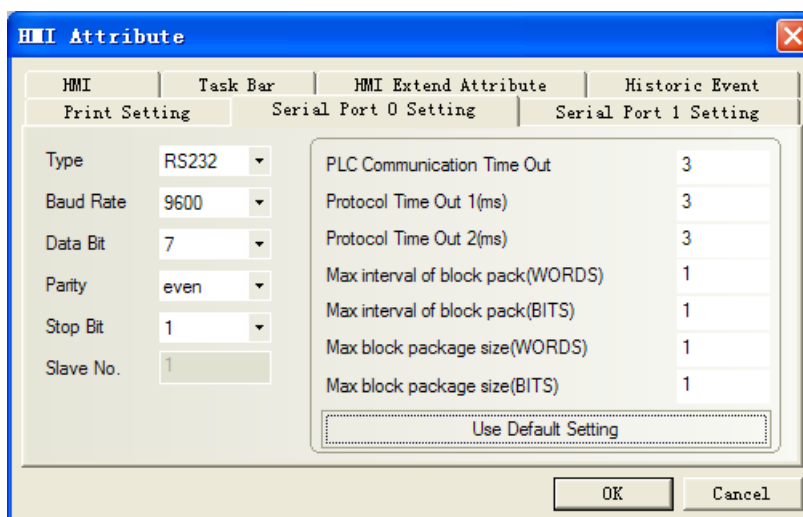

### Supported Device

Device	Bit Address	Word Address	Format	Notes
Relay	CB 00-270F	-----	HHHH	
ERCD	ERCD 0.00-9896.7F	-----	HHHH.HH	
Register	-----	CD00-FF	HH	
External Register	-----	ERCD 0000.00-9896.7F	HHHH.HH	
Internal data processing control address bit	-----	M1 0~270F	HHHH	Read only
Internal data processing control address bit	-----	M2 0~270F	HHHH	Read only
Internal data processing control address bit	-----	M3 0~270F	HHHH	Read only

**NOTE:**

- 1) ERCD is Extended register, the four position before radix point are C1,C2,C3,C4.The two positions after radix point are S1, S2.
- 2) Parameter code corresponding with CD are C1,C2;
- 3) Parameter code corresponding with CB set to "1";Eg:"Bit State Setting" part, addr type CB67, set the state to "1".
- 4) M1 correspond to parameter ":"; M2 correspond to parameter";"; M3 correspond to parameter"<";

© **Cable Diagram**

**MKS controller RS232 communication cable**

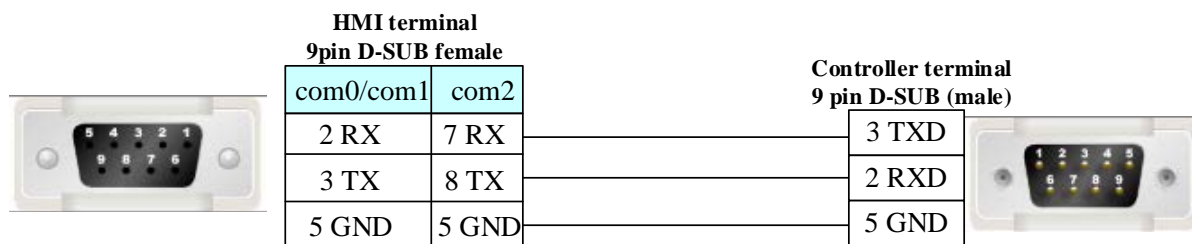

**4.56 Modbus**

© **Serial Communication**

Series	CPU	Link Module	SIO type	Driver
Modbus RTU Extend		RS232/485 on the CPU unit		Modbus RTU Extend
Modbus RTU Extend (Zero-based Addressing)		RS232/485 on the CPU unit		Modbus RTU Extend (Zero-based Addressing)
Modbus RTU Slave		RS232/485 on the CPU unit		Modbus RTU Slave
Modbus RTU MT500 compatible		RS232/485 on the CPU unit		Modbus RTU MT500 compatible
Modbus ASCII		RS232/485 on the CPU unit		Modbus ASCII
Modbus TCP			Ethernet	Modbus TCP
Modbus TCP Slave			Ethernet	Modbus TCP Slave
Modbus UDP			Ethernet	Modbus UDP
Modbus UDP Slave			Ethernet	Modbus UDP Slave

© **System configuration**

Series	CPU	Link Module	COMM Type	Parameter	Cable

Modbus RTU Extend		RS232/485 on the CPU unit	RS232/RS485	<a href="#">Setting</a>	<a href="#">Your owner cable</a>
Modbus RTU Extend (Zero-based Addressing)		RS232 on the CPU unit	RS232/485	<a href="#">Setting</a>	<a href="#">Your owner cable</a>
Modbus RTU Slave		RS232/485 on the CPU unit	RS232/RS485	<a href="#">Setting</a>	<a href="#">Your owner cable</a>
Modbus RTU MT500 compatible		RS232/485 on the CPU unit	RS232/RS485	<a href="#">Setting</a>	<a href="#">Your owner cable</a>
Modbus ASCII		RS232/485 on the CPU unit	RS232/RS485	<a href="#">Setting</a>	<a href="#">Your owner cable</a>
Modbus TCP			Ethernet	<a href="#">Connection Configuration</a>	
Modbus TCP Slave			Ethernet		
Modbus UDP			Ethernet	<a href="#">Connection Configuration</a>	
Modbus UDP Slave			Ethernet		

### Ⓢ Communication Setting

#### Modbus RTU Extend protocol

##### RS232 communication

Default communication parameters: 9600, 8, even, 1; station: 1

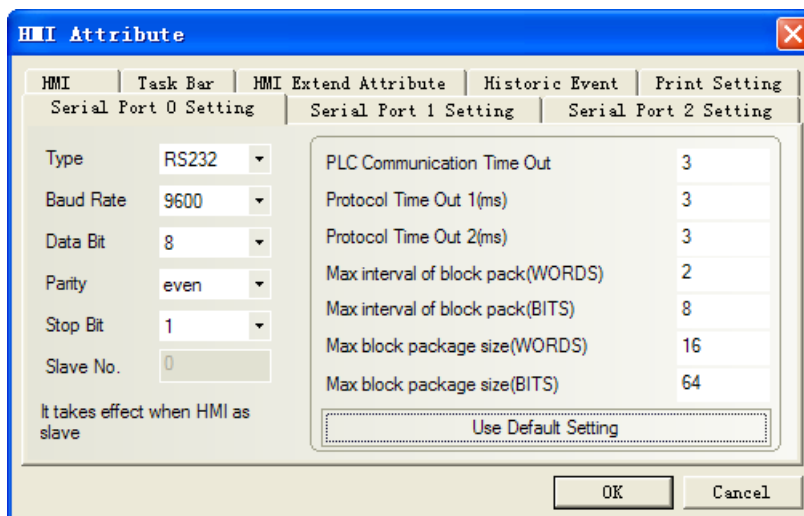

#### Modbus RTU Extend(Zero-based Addressing) protocol

##### RS232 communication

Default communication parameters: 9600, 8, even, 1; station: 1

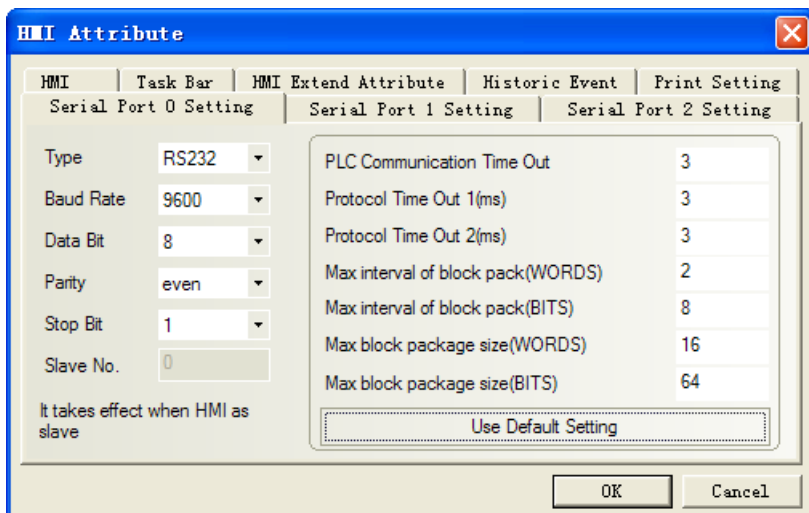

**Modbus RTU Slave protocol**

**RS232 communication**

Default communication parameters: 9600, 8, even, 1; station: 1

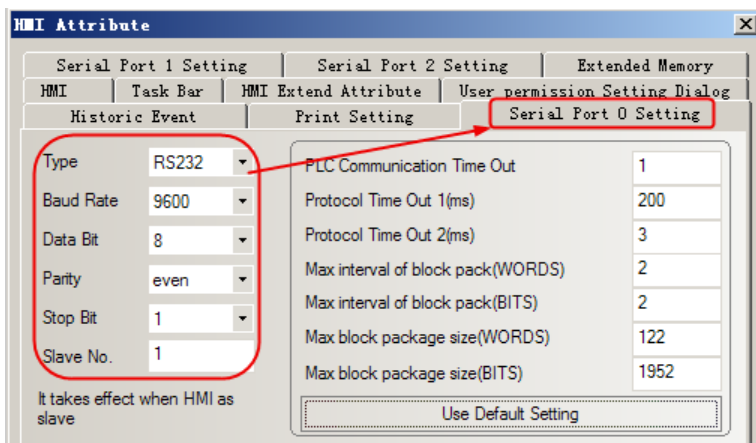

**Modbus RTU MT500 compatible protocol**

**RS232 communication**

Default communication parameters: 9600, 8, even, 1; station: 1

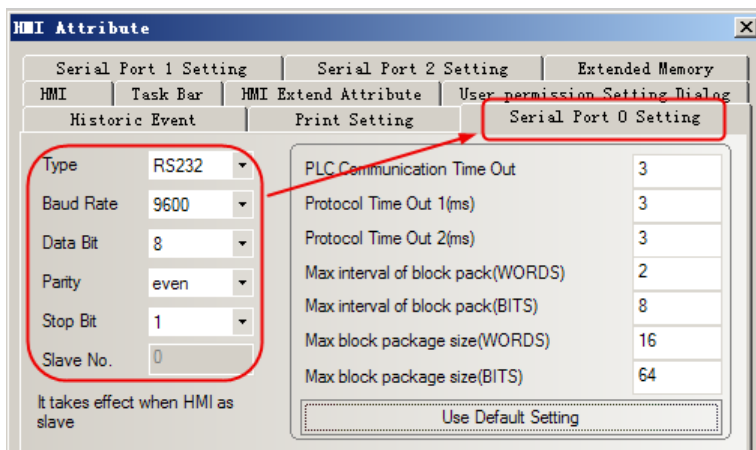

### Modbus ASCII protocol

#### RS232 communication

Default communication parameters: 9600, 8, even, 1; station: 1

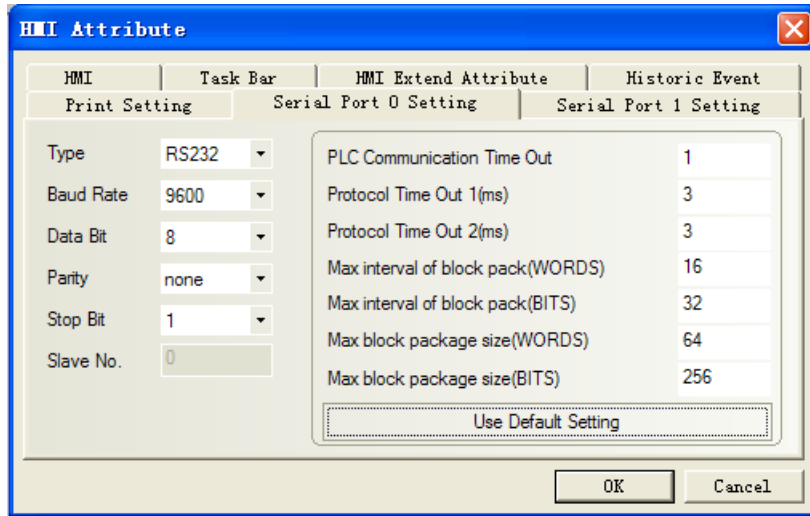

### Modbus TCP protocol

#### Network configuration

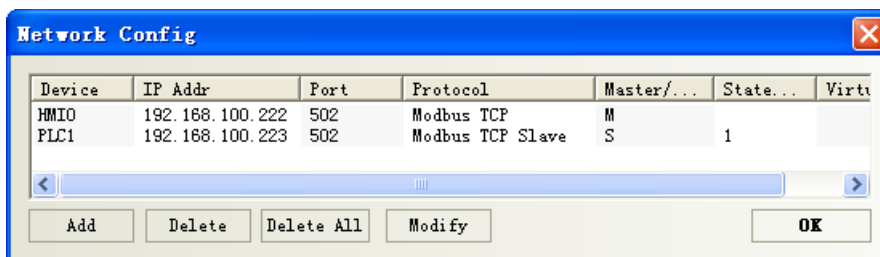
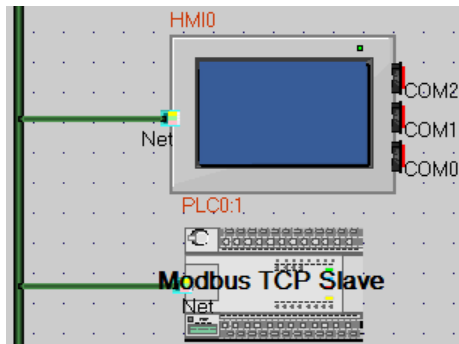

### Modbus UDP protocol

#### Network configuration

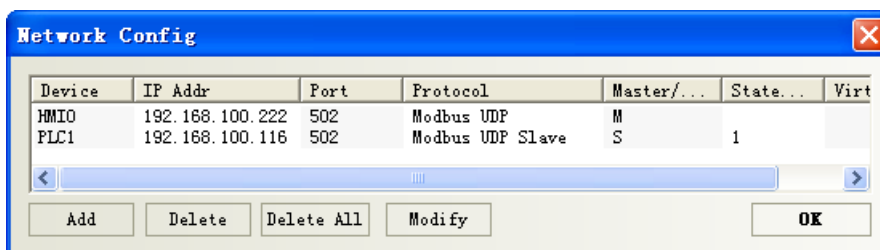
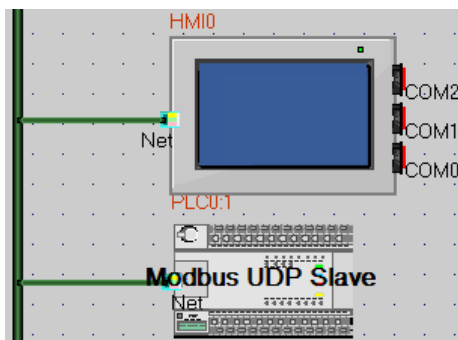

© Supported Device

Modbus RTU Extend

Device	Bit Address	Word Address	Format	Notes
Output Relay	0X1-65535	-----	DDDDD	
Input Relay	1X1-65535	-----	DDDDD	read only
Input Relay	3X_bit 1.00-65535.15	-----	DDDDD	read only
Output Relay	4X_bit 1.00-65535.15	-----	DDDDD	
4X Single Write Relay	6X_bit 1.00-65535.15	-----	DDDDD.DD	
Input Register	-----	3X1-65535	DDDDD	read only
Output Register	-----	4X1-65535	DDDDD	
Data Register	-----	5X1-65535	DDDDD	
4X single word write	-----	6X1-65535	DDDDD	
4X double word swap		4X-DINV 1-65535	DDDDD	
3X double word swap		3X-DINV 1-65535	DDDDD	

NOTE:

1. 5X is the byte register; 4X-DINV, 3X-DINV is the word high and low-bit register. The relation of them as follow:

Word:

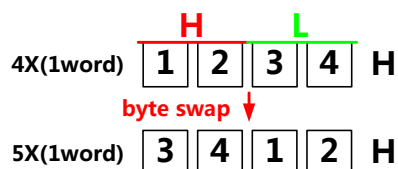

Dword:

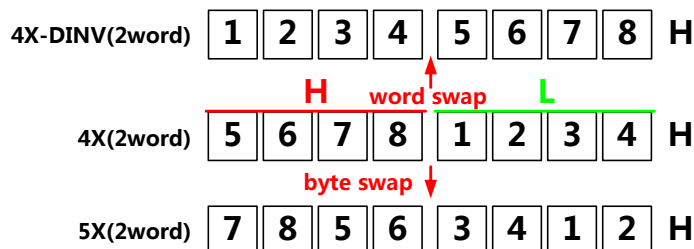

Text:

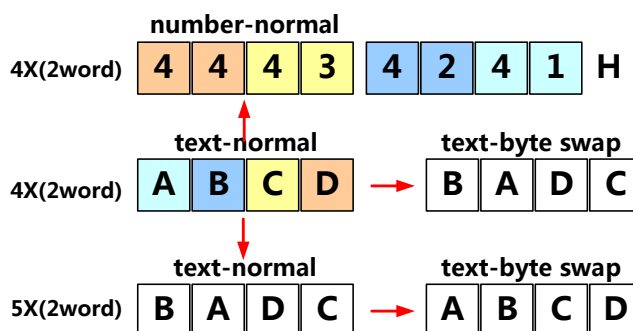

- Not use the odd and even address in the same window by 4X-DINV, only odd address or even address in the same window.

### Modbus RTU Extend(Zero-based Addressing)

Device	Bit Address	Word Address	Format	Notes
Output Relay	0X0-65535	-----	DDDDD	
Input Relay	1X0-65535	-----	DDDDD	read only
Input Relay	3X_bit 0.00-65535.15	-----	DDDDD	read only
Output Relay	4X_bit 0.00-65535.15	-----	DDDDD	
4X Single Write Relay	6X_bit 0.00-65535.15	-----	DDDDD.DD	
Input Register	-----	3X0-65535	DDDDD	read only
Output Register	-----	4X0-65535	DDDDD	
Data Register	-----	5X0-65535	DDDDD	
4X single word write	-----	6X0-65535	DDDDD	
4X double word swap		4X-DINV 0-65535	DDDDD	
3X double word swap		3X-DINV 0-65535	DDDDD	

**NOTE:**

- 5X is the byte register; 4X-DINV, 3X-DINV is the word high and low-bit register. The relation of them as follow:

**Word:**

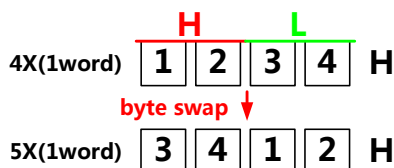

**Dword:**



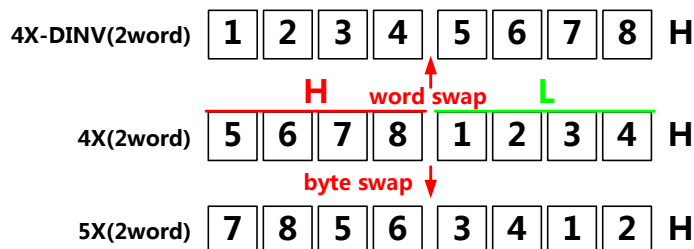

Text:

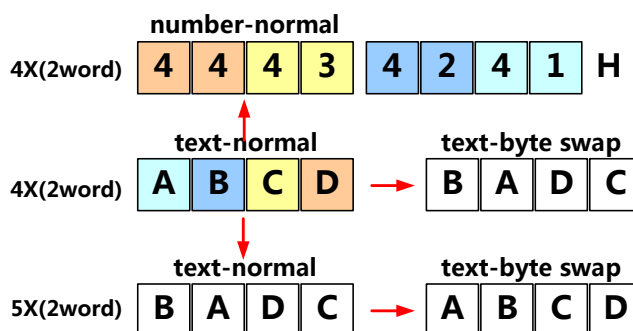

2. Not use the odd and even address in the same window by 4X-DINV, only odd address or even address in the same window.

**Modbus RTU Slave**

Device	Bit Address	Word Address	Format	Notes
Output Relay	LB 0-9999	-----	DDDDD	Mapping to 0X 1~9999
Data Register	-----	LW 0-65535	DDDDD	Mapping to 4X 1~9999

**Modbus RTU MT500 compatible**

Device	Bit Address	Word Address	Format	Notes
Output Relay	0X 1-65535	-----	DDDDD	
Input Relay	1X 1-65535	-----	DDDDD	read only
Input Relay	3X_bit 1.00-65535.15	-----	DDDDD.DD	read only
Output Relay	4X_bit 1.00-65535.15	-----	DDDDD.DD	
Input Register	-----	3X 1-65535	DDDDD	read only
Output Register	-----	4X 1-65535	DDDDD	

**Modbus ASCII**

Device	Bit Address	Word Address	Format	Notes
Output Relay	0X1-65535	-----	DDDDD	
Input Relay (read only)	1X1-65535	-----	DDDDD	
Input Register (read only)	-----	3X1-65535	DDDDD	
Output Register	-----	4X1-65535	DDDDD	

**Modbus TCP Slave**

Device	Bit Address	Word Address	Format	Notes
Output Relay	0X 1-65535	-----	DDDDD	

Input Relay	1X 1-65535	-----	DDDDD	read only
Input Relay	3X_bit 1.00-65535.15	-----	DDDDD.DD	read only
Data relay	4X_bit 1.00-65535.15	-----	DDDDD.DD	
4X Single Write Relay	6X_bit 1.00-65535.15	-----	DDDDD.DD	
Input Register	-----	3X 1-65535	DDDDD	read only
Output Register	-----	4X 1-65535	DDDDD	
4X single word write	-----	6X1-65535	DDDDD	
Data Register	-----	4X-DINV 1-65535	DDDDD	
Data Register	-----	3X-DINV 1-65535	DDDDD	

**NOTE:** 4X-DINV, 3X-DINV is the word high and low-bit counter.

### Modbus UDP Slave

Device	Bit Address	Word Address	Format	Notes
Output Relay	0X1-65535	-----	DDDDD	
Input Relay	1X1-65535	-----	DDDDD	read only
Input Relay	3X_bit 1.00-65535.15	-----	DDDDD.DD	read only
Data relay	4X_bit 1.00-65535.15	-----	DDDDD.DD	
4X Single Write Relay	6X_bit 1.00-65535.15	-----	DDDDD.DD	
Input Register	-----	3X1-65535	DDDDD	read only
Output Register	-----	4X1-65535	DDDDD	
Data Register	-----	5X1-65535		
4X single word write	-----	6X1-65535	DDDDD	
Data Register	-----	4X-DINV 1-65535	DDDDD	
Data Register	-----	3X-DINV 1-65535	DDDDD	

### © Cable Diagram

#### RS232 communication cable

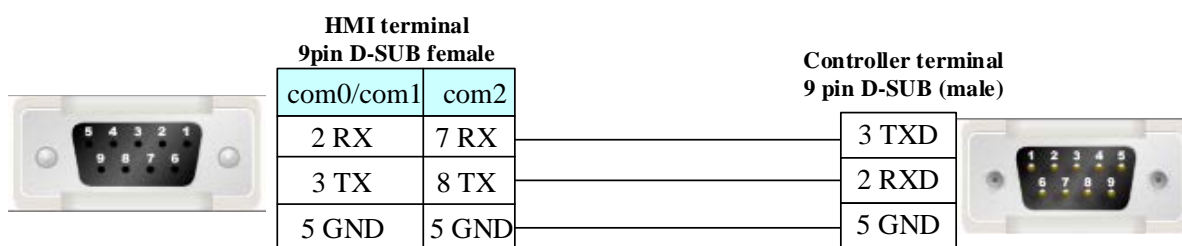

#### RS485 communication cable

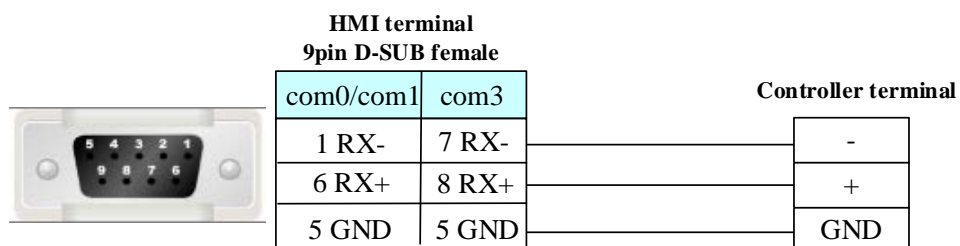

#### Ethernet communication cable

Cross-connection or crossover network cable can be used as communication cable via the hub  
 Refer to [3.3 Download by Network Ethernet](#) for method of making connection cable.

## 4.57 MODROL

### Serial Communication

Series	CPU	Link Module	Driver
MODROL	IMS-GF3-4011E	RS485 on the CPU unit	MODROL

### System configuration

Series	CPU	Link Module	COMM Type	Parameter	Cable
MODROL	IMS-GF3-4011E	RS485 on the CPU unit	RS485	<a href="#">Setting</a>	<a href="#">Your owner cable</a>

### Communication Setting

#### HMI Setting

Default communication: 9600, 8, none, 1; station: 1

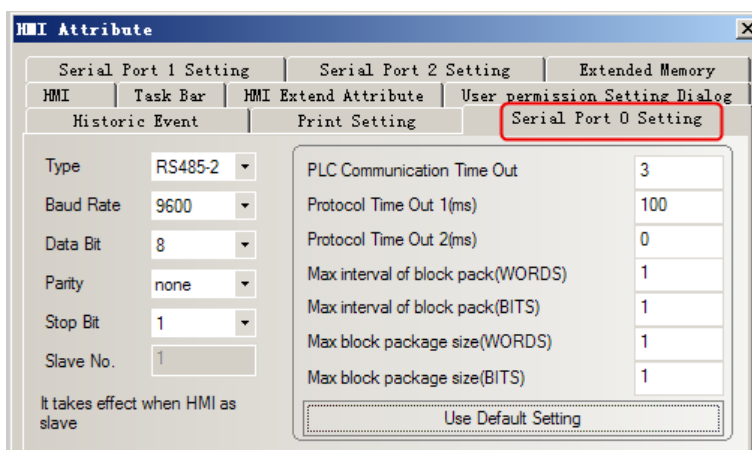

### Supported Device

Device	Bit Address	Word Address	Format	Notes
	-----	D_1 0-9999	DDDD	One byte
	-----	D_2 0-9999	DDDD	Two byte
	-----	D_3 0-9999	DDDD	Three byte

### Cable Diagram

#### MODROL RS485

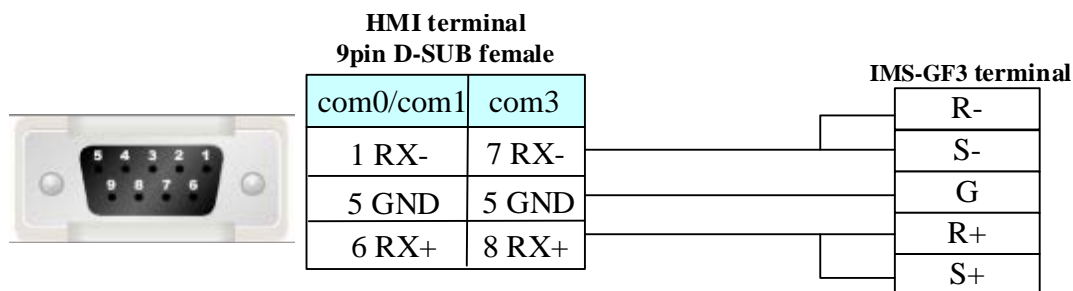

## 4.58 OE MAX

### ◎ Serial Communication

Series	CPU	Link Module	Driver
NX7	NX7	RS232 on the CPU unit	OE MAX NX7

### ◎ System configuration

Series	CPU	Link Module	COMM Type	Parameter	Cable
NX7	NX7	RS232 on the CPU unit	RS232	<a href="#">Setting</a>	<a href="#">Your owner cable</a>

### ◎ Communication Setting

Default communication: 19200, 8, none, 1; station: 1

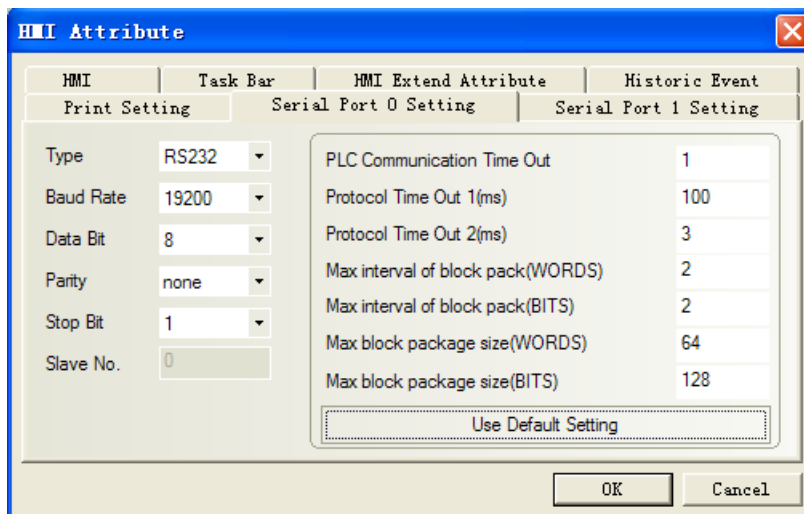

### ◎ Supported Device

Device	Bit Address	Word Address	Format	Notes
Input/Output Relay	R 0.0–127.15	-----	DDD.DD	
General Relay	L 0.0–63.15	-----	DD.DD	
General Relay	M 0.0–127.15	-----	DDD.DD	
Keep Relay	K 0.0–127.15	-----	DDD.DD	
Timer Relay	TC 0–255	-----	DDD	

Special Relay	F 0.0–15.15	-----	DD.DD	
Internal HSC	-----	R_word 0-127	DDD	
General Register	-----	L_word 0-63	DD	
General Register	-----	M_word 0-127	DDD	
Keep Register	-----	K_word 0-127	DDD	
General Register	-----	F_word 0-15	DD	
Timer/Counter Register	-----	SV_word 0-255	DDD	
Timer/Counter Register	-----	PV_word 0-255	DDD	
General Register	-----	W_word 0-2047	DDDD	
Special Register	-----	SR_word 0-511	DDD	

◎ Cable Diagram

Oemax RS232 communication cable

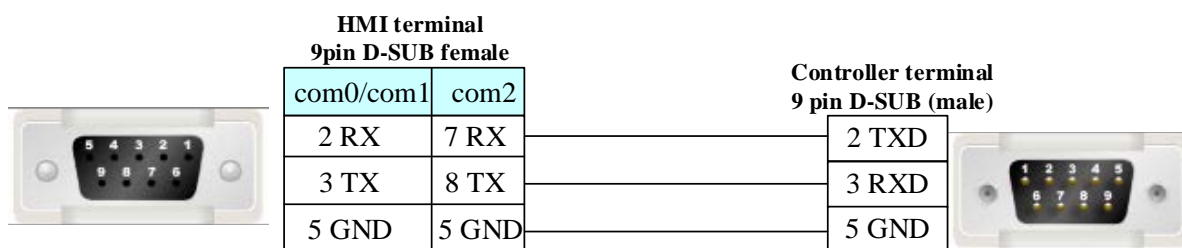

4.59 Omron Corporation

◎ Serial Communication

Series	CPU	Link Module	Driver
SYSMAC C	CP1H	RS232 on the CPU unit	OMRON C Series Host Link OMRON CP Series Host Link
	CP1L	CP1W-CIF01	
	CP1E	CP1W-CIF11/CIF12	
	C200H	C200H-LK202 C120-LK201-V1	OMRON C Series Host Link
	C200HS	C200H-LK201	
		C200H-LK202	
		C120-LK201-V1	
	Link I/F on the CPU unit		
	Peripheral port on the CPU unit		
C500	C120-LK201-V1		
C500F	C120-LK202-V1		
C1000H	C500-LK201-V1		
C2000	C500-LK203		
C2000H			

	C1000HF	C500-LK201-V1 C500-LK203	
	C20H/28H/40H	Link I/F on the CPU unit	
	C20PF/28PF C40PF/60PF	C120-LK201-V1 C120-LK202-V1	
	C120 C120F	C120-LK201-V1 C120-LK202-V1	
	CQM1-CPU11	Peripheral port on the CPU unit	
	CQM1-CPU21	RS232C port on the CPU unit	
	CQM1-CPU41 CQM1-CPU42 CQM1-CPU43 CQM1-CPU44 CQM1-CPU41-V1 CQM1-CPU42-V1 CQM1-CPU43-V1 CQM1-CPU44-V1	Peripheral port on the CPU unit	
	CPM2C	Peripheral port on the CPU unit	
		Peripheral port on the CPM2C-CIF01	
		RS232C port on the CPM2C-CIF01	
		RS232C port on the CPM2C-CIF11	
		Terminal block on the CPM2C-CIF11	
	CQM1H-CPU11	Peripheral port on the CPU unit	
	CQM1H-CPU21	RS232 on the CPU unit	
	CQM1H-CPU51 CQM1H-CPU61	Peripheral port on the CPU unit	
		RS232 on the CPU unit	
		RS232C port on the CQM1H-SCB41	
		RS422A/485 port on the CQM1H-SCB41	
	CPM1 CPM1A CPM1A-V1 CPM2AH	RS232 on the CPU unit	<a href="#">OMRON C Series Host Link</a>
			<a href="#">OMRON CPM Series Host Link</a>
SYSMAC CJ2	CJ2M-CPU13	RS232 on the CPU unit	<a href="#">OMRON CJ/CS Series Host Link</a>
SYSMAC CJ	CJ1G-CPU45 CJ1G-CPU44 CJ1G-CPU45H	RS232 on the CPU unit	

	CJ1G-CPU44H CJ1G-CPU43H CJ1G-CPU42H CJ1M-CPU23 CJ1M-CPU22 CJ1M-CPU21 CJ1M-CPU13 CJ1M-CPU12 CJ1M-CPU11 CJ1H-CPU66H CJ1H-CPU65H	Peripheral port on the CPU unit  CJ1W-SCU41	
SYSMAC CS	CS1G-CPU45 CS1G-CPU44 CS1G-CPU43 CS1G-CPU42 CS1G-CPU45H CS1G-CPU44H CS1G-CPU43H CS1G-CPU42H CS1G-CPU45-V1 CS1G-CPU44-V1 CS1G-CPU43-V1 CS1G-CPU42-V1 CS1H-CPU67 CS1H-CPU66 CS1H-CPU65 CS1H-CPU64 CS1H-CPU63 CS1H-CPU67H CS1H-CPU66H CS1H-CPU65H CS1H-CPU64H CS1H-CPU63H CS1H-CPU67-V1 CS1H-CPU66-V1 CS1H-CPU65-V1 CS1H-CPU64-V1 CS1H-CPU63-V1	RS232 on the CPU unit  Peripheral port on the CPU unit  CS1W-SCU21 CS1W-SCB21 CS1W-SCB41	OMRON CJ/CS Series Host Link

### ◎ Network Communication

Series	CPU	Link Module	Driver
SYSMAC CJ/CS	CJ2M-CPU35	EtherNet/IP port on CPU Unit	OMRON CJ Series Ethernet(TCP Slave)
		CJ1W-ETN21	
	CJ2M-CPU3*	EtherNet/IP port on CPU Unit	Omron CJ/CS/NJ/NX Series

	CS1H	CS1W-ETN21/EIP21	Ethernet (UDP Slave)
	CS1G	CJ1W-ETN21/EIP21	
		CJ2H-***-EIP	
SYSMAC NJ	NJ*01	EtherNet/IP port on CPU Unit	
SYSMAC C	CP1L-EM	EtherNet/IP port on CPU Unit	OMRON CP Series Ethernet (UDP Slave)
	CP1L-EL		
	CP1H	EtherNet/IP port on CPU Unit	
	CP1L	CP1W-CIF41	
NJ/NX	NJ501	port1 EtherNet/IP	OMRON NJ_NX Series EtherNet_IP(Free tag Names)

### ◎ Serial System configuration

Series	CPU	Link Module	COMM Type	Parameter	Cable	
SYSMAC C	CP1H CP1L CP1E	RS232 on the CPU unit	RS232	<a href="#">Setting</a>	<a href="#">Your owner cable</a>	
		CP1W-CIF01				
		CP1W-CIF11/CIF12	RS422	<a href="#">Setting</a>	<a href="#">Your owner cable</a>	
	CPM2AH	RS232 on the CPU unit	RS232	<a href="#">Setting</a> <a href="#">Setting</a>	<a href="#">Your owner cable</a>	
SYSMAC CJ2	CJ2M-CPU13	RS232 on the CPU unit	RS232	<a href="#">Setting</a>	<a href="#">Your owner cable</a>	
SYSMAC CJ	CJ1G-CPU45 CJ1G-CPU44 CJ1G-CPU45H CJ1G-CPU44H CJ1G-CPU43H CJ1G-CPU42H	RS232 on the CPU unit	RS232	<a href="#">Setting</a>	<a href="#">Your owner cable</a>	
		Peripheral port on the CPU unit*1	RS232	<a href="#">Setting</a>	<a href="#">Your owner cable</a>	
	CJ1W-SCU41					RS232
			RS422	<a href="#">Setting</a>	<a href="#">Your owner cable</a>	
	SYSMAC CS		CS1G-CPU45 CS1G-CPU44 CS1G-CPU43 CS1G-CPU42	RS232 on the CPU unit	RS232	<a href="#">Setting</a>



	CS1G-CPU45H CS1G-CPU44H CS1G-CPU43H CS1G-CPU42H CS1G-CPU45-V1 CS1G-CPU44-V1 CS1G-CPU43-V1 CS1G-CPU42-V1	Peripheral port on the CPU unit*1	RS232	<a href="#">Setting</a>	<a href="#">Your owner cable</a>
	CS1H-CPU67 CS1H-CPU66	CS1W-SCU21	RS232	<a href="#">Setting</a>	<a href="#">Your owner cable</a>
	CS1H-CPU65 CS1H-CPU64	CS1W-SCB21	RS232	<a href="#">Setting</a>	
	CS1H-CPU63 CS1H-CPU67H CS1H-CPU66H CS1H-CPU65H CS1H-CPU64H CS1H-CPU63H CS1H-CPU67-V1 CS1H-CPU66-V1 CS1H-CPU65-V1 CS1H-CPU64-V1 CS1H-CPU63-V1	CS1W-SCB41	RS232	<a href="#">Setting</a>	<a href="#">Your owner cable</a>
			RS422	<a href="#">Setting</a>	

\*1 Must set the switch DIP 4 to be on

### ◎ Network System configuration

Series	CPU	Link Module	Connect Type	Parameter	Cable
SYSMAC CJ/CS	CJ2M-CPU35	EtherNet/IP port on CPU Unit	Ethernet(TCP Slave)	<a href="#">Setting</a>	<a href="#">Your own cable</a>
		CJ1W-ETN21			
	CJ2M-CPU3* CS1H CS1G	EtherNet/IP port on CPU Unit	Ethernet (UDP Slave)	<a href="#">Setting</a>	<a href="#">Your own cable</a>
		CS1W-ETN21/EIP21			
	CJ1W-ETN21/EIP21 CJ2H-***-EIP				
SYSMAC NJ	NJ*01	EtherNet/IP port on CPU Unit			
SYSMAC C	CP1L-EM	EtherNet/IP port on CPU Unit	Ethernet (UDP Slave)	<a href="#">Setting</a>	<a href="#">Your own cable</a>
	CP1L-EL				
	CP1H CP1L	EtherNet/IP port on CPU Unit			
		CP1W-CIF41			
NJ/NX	NJ501	PORT1 EtherNet/IP	Ethernet	<a href="#">Setting</a>	<a href="#">Your own cable</a>

## ◎ Serial Communication Setting

### OMRON CP Series Host Link protocol

#### HMI Setting

Default communication: 9600, 7, even, 2; station: 0

#### RS232 communication

**HMI Attribute**

HMI | Task Bar | HMI Extend Attribute | Historic Event | Print Setting

Serial Port 0 Setting | Serial Port 1 Setting | Serial Port 2 Setting

Type: RS232  
 Baud Rate: 9600  
 Data Bit: 7  
 Parity: even  
 Stop Bit: 2  
 Slave No.: 0

It takes effect when HMI as slave

PLC Communication Time Out: 3  
 Protocol Time Out 1(ms): 50  
 Protocol Time Out 2(ms): 3  
 Max interval of block pack(WORDS): 16  
 Max interval of block pack(BITS): 64  
 Max block package size(WORDS): 32  
 Max block package size(BITS): 128

Use Default Setting

OK Cancel

#### RS422 communication

**HMI Attribute**

HMI | Task Bar | HMI Extend Attribute | Historic Event | Print Setting

Serial Port 0 Setting | Serial Port 1 Setting | Serial Port 2 Setting

Type: RS485-4  
 Baud Rate: 9600  
 Data Bit: 7  
 Parity: even  
 Stop Bit: 2  
 Slave No.: 0

It takes effect when HMI as slave

PLC Communication Time Out: 3  
 Protocol Time Out 1(ms): 50  
 Protocol Time Out 2(ms): 3  
 Max interval of block pack(WORDS): 16  
 Max interval of block pack(BITS): 64  
 Max block package size(WORDS): 32  
 Max block package size(BITS): 128

Use Default Setting

OK Cancel

**NOTE:** Make sure that the switch DIP1~6 of PLC must be OFF when using OMRON CP Series Host Link protocol.

NO.	Setup contents	default status
1	ON: write enable OFF:write disable	OFF
2	ON: program automaticly transmit from card to PLC when power up OFF: program can't automaticly transmit from card to PLC when power up	OFF
3	OFF: OFF(default)	OFF
4	ON: communication port1,Toolbus(default) OFF:Port 1 communications settings according to the PLC system CPU setting	OFF

5	ON: communication port2,Toolbus(default) OFF:Port 2 communications settings according to the PLC system CPU setting	OFF
6	ON: customer use ( A395.12 = ON) OFF: customer use ( A395.12 = OFF)	OFF

### OMRON C Series Host Link protocol

Default communication: 19200, 7, even, 2; station: 0

#### RS232 communication

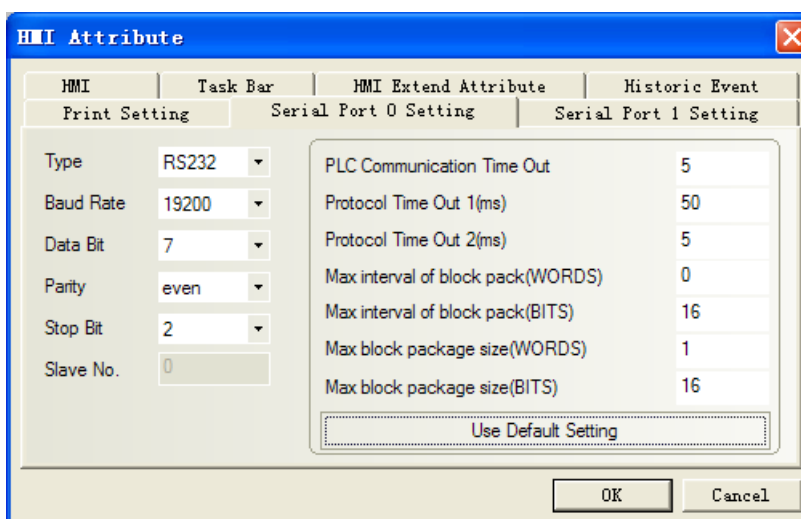

#### RS422 communication

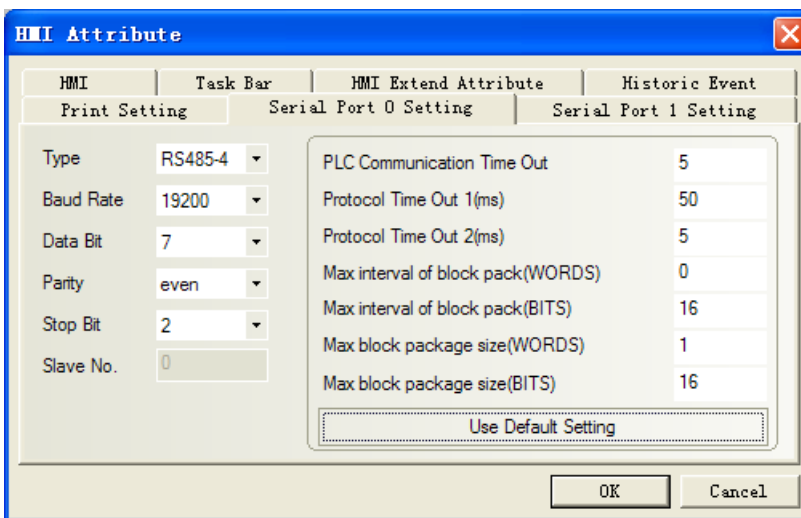

### OMRON CPM Series Host Link protocol

Default communication: 9600, 7, even, 2; station: 0

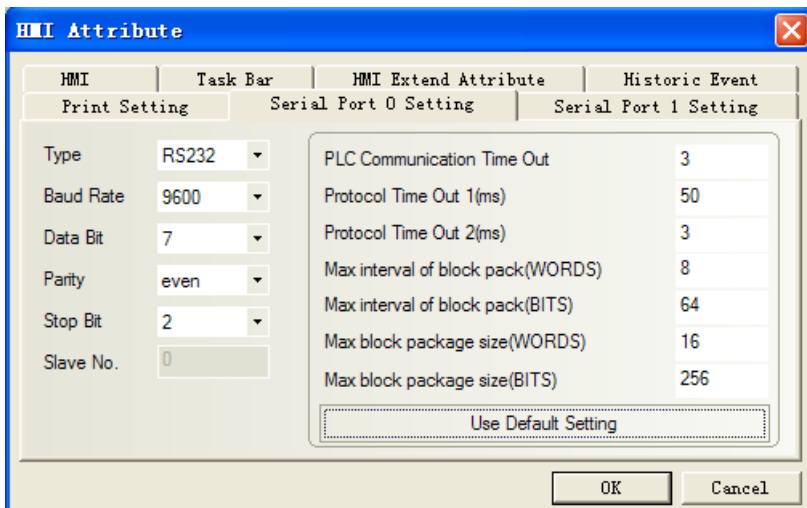

**NOTE:** Select custom communication parameters (non-standard communication parameters), the switch of PLC must be OFF.

### OMRON CJ/CS Series Host Link protocol

**RS232** Default communication: 9600, 7, even, 2; station: 0

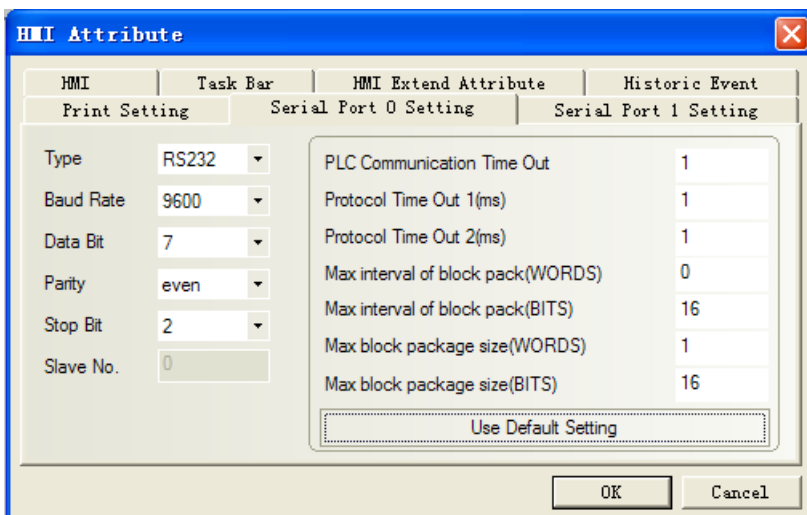

**NOTE:** 1. CJ1M switch DIP: SW1, SW2, SW3, SW5, SW8 must be off, but SW4, SW6, SW7 are optional.  
2. CJ1M switches DIP 1~8 are OFF (default).

**RS422** Default communication: 9600, 7, even, 2; station: 0

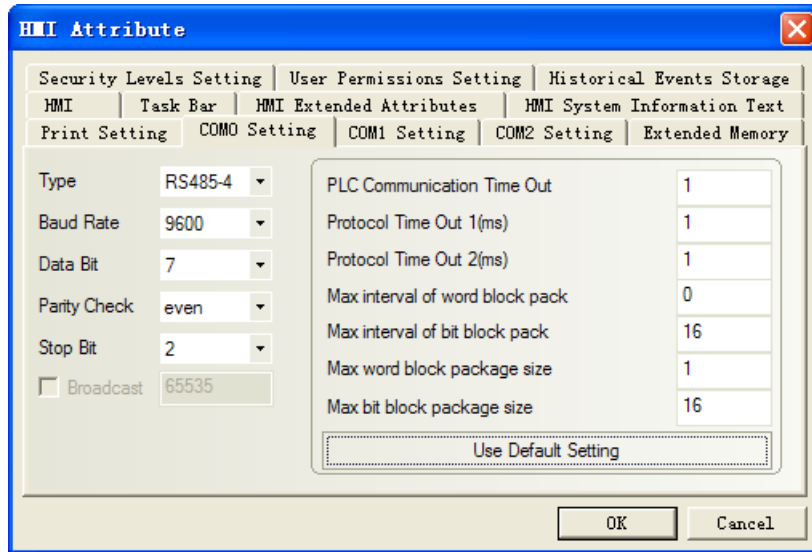

### ◎ Network Communication Setting

#### OMRON CJ Series Ethernet(TCP Slave)

#### HMI Setting

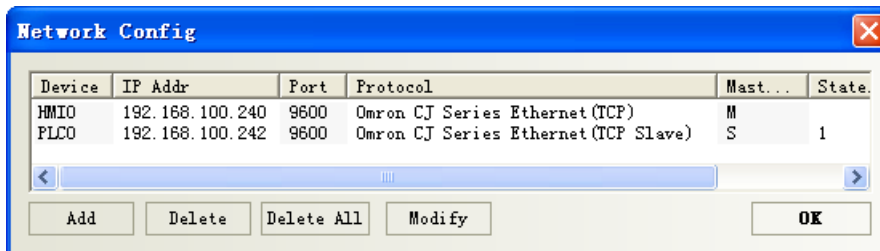
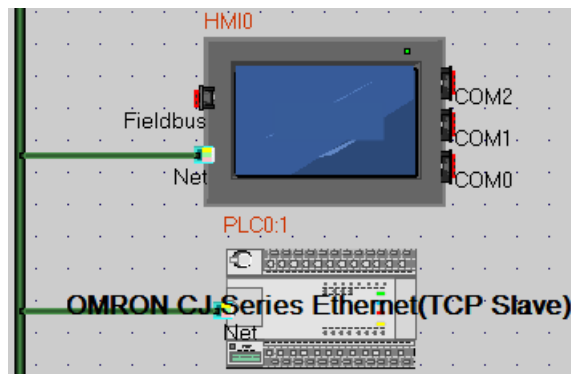

#### PLC Setting

1. Double-click the IO table and the unit set, find the Ethernet communication module

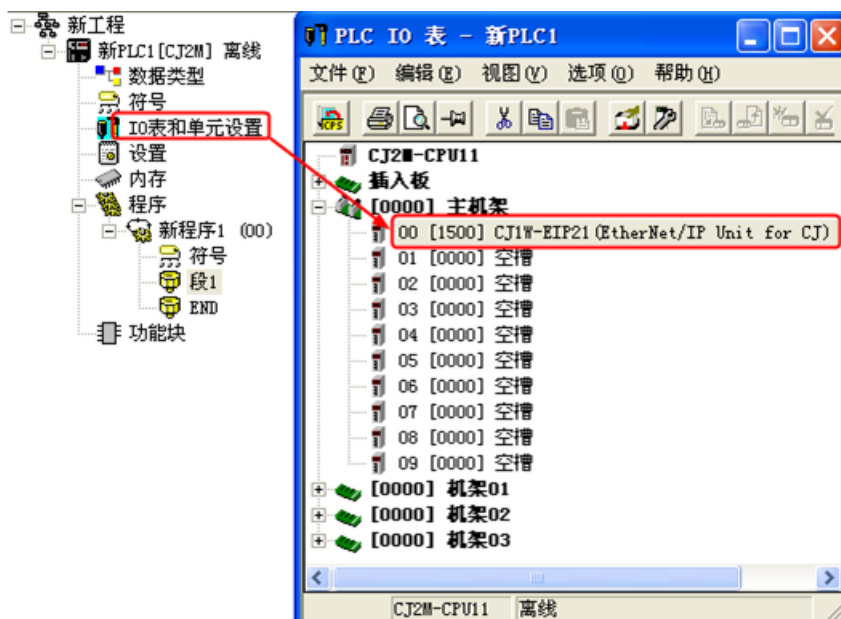

2. Double-click the Ethernet communication module, set the parameters

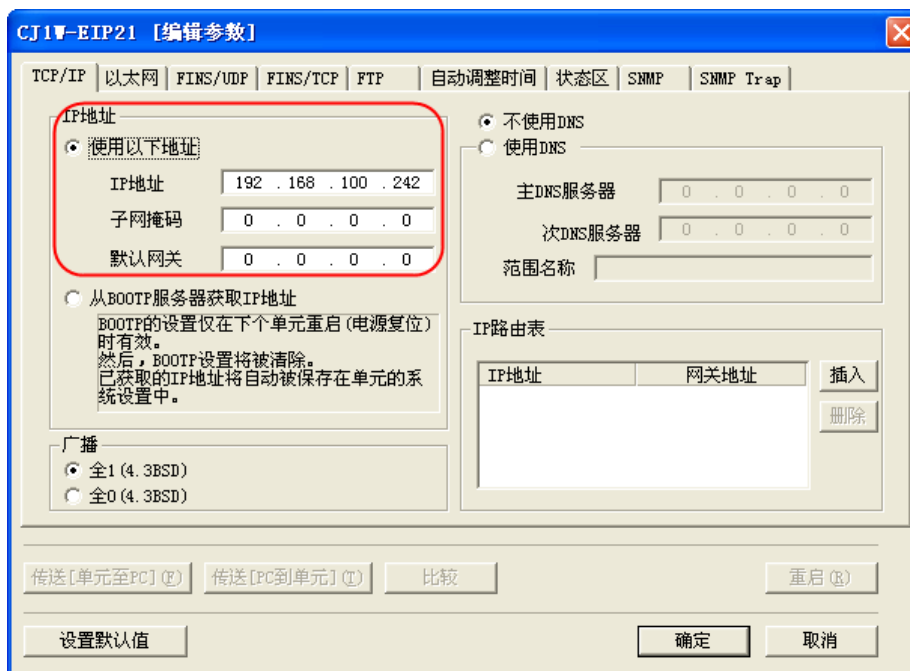

## OMRON CJ/CS/NJ/NX Series Ethernet(UDP Slave) HMI Setting

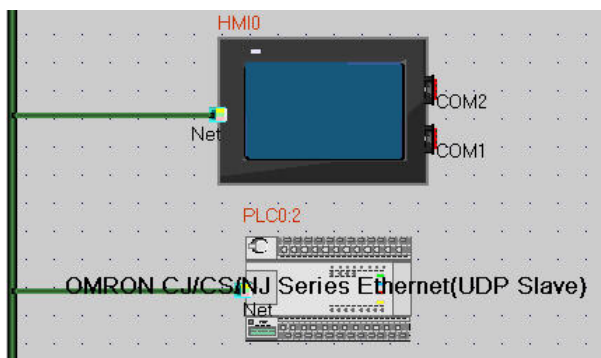

Attention: HMI and PLC must be set in the same network, while the node ID should be different.

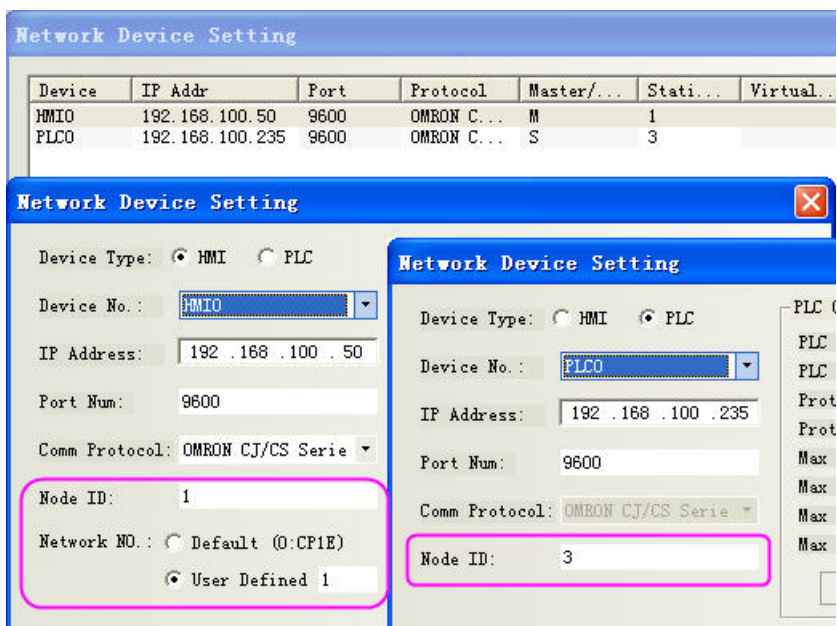

### PLC Setting

Please use CX-Integrator to modify

1. Choose the right type to get the PLC and its software connected
2. Set the PLC into programming mode
3. Read the data and show the connected device

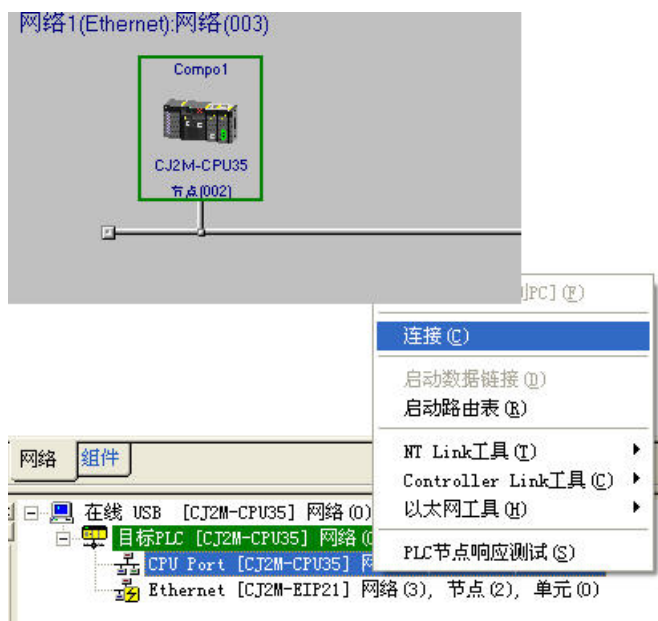

4. Double click the device to modify the related parameter, for example IP Address



5. Set the Network number and Node ID

(1) Network number

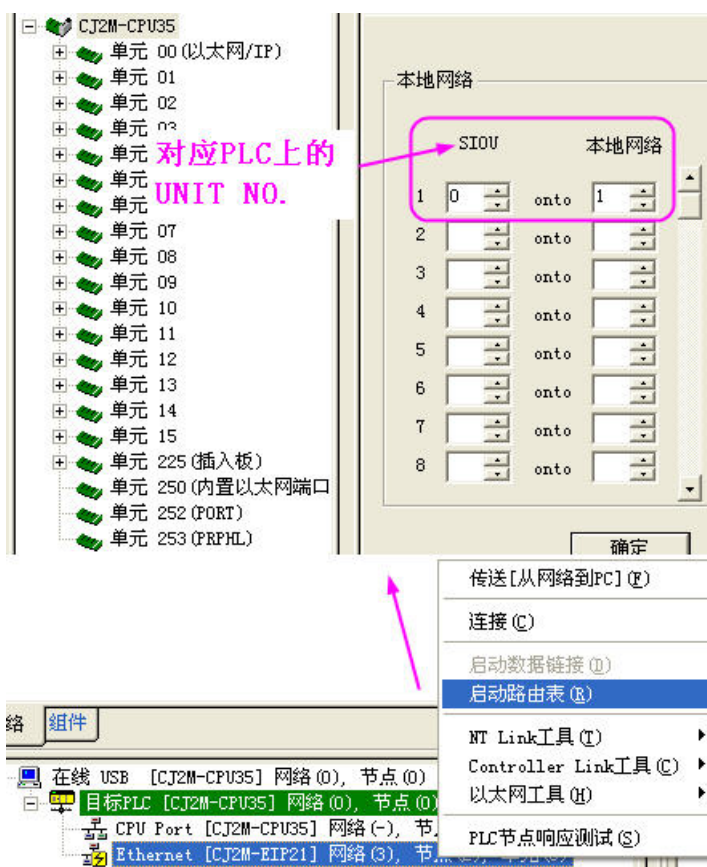

(2) You can change the Node ID by the switch on the device (NODE No.)

Notice: NX1P2 needs to set "sysmac studio", to check the register used, as shown in the figure below



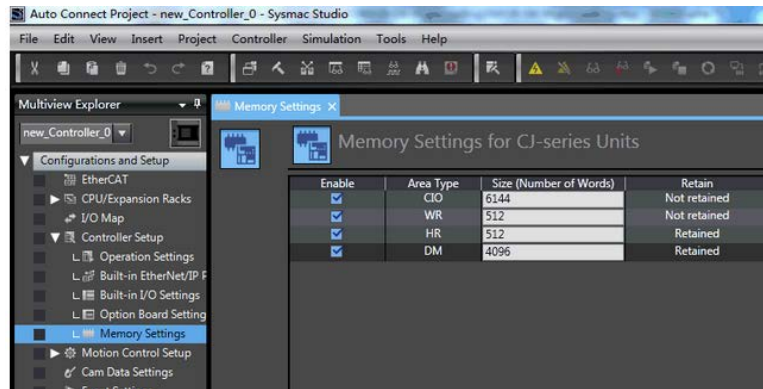

## OMRON CP Series Ethernet(UDP Slave) HMI Setting

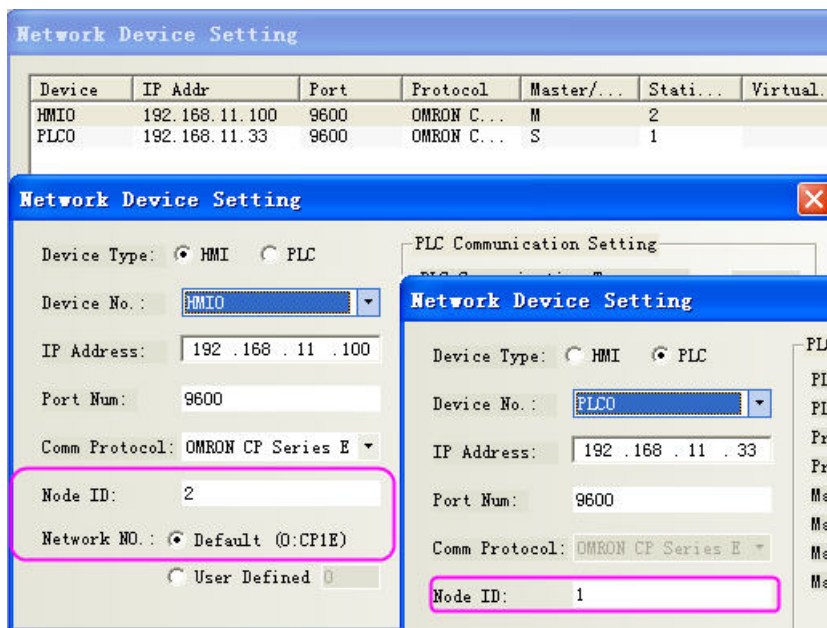
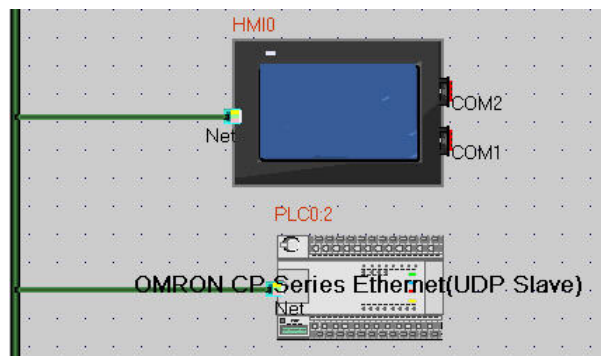

## PLC Setting

Type in IE the IP address (ex: <http://192.168.11.33/C00.HTM>) and the password (ex:ETHERNET), then you entry this interface.Later,you can modify the parameter.

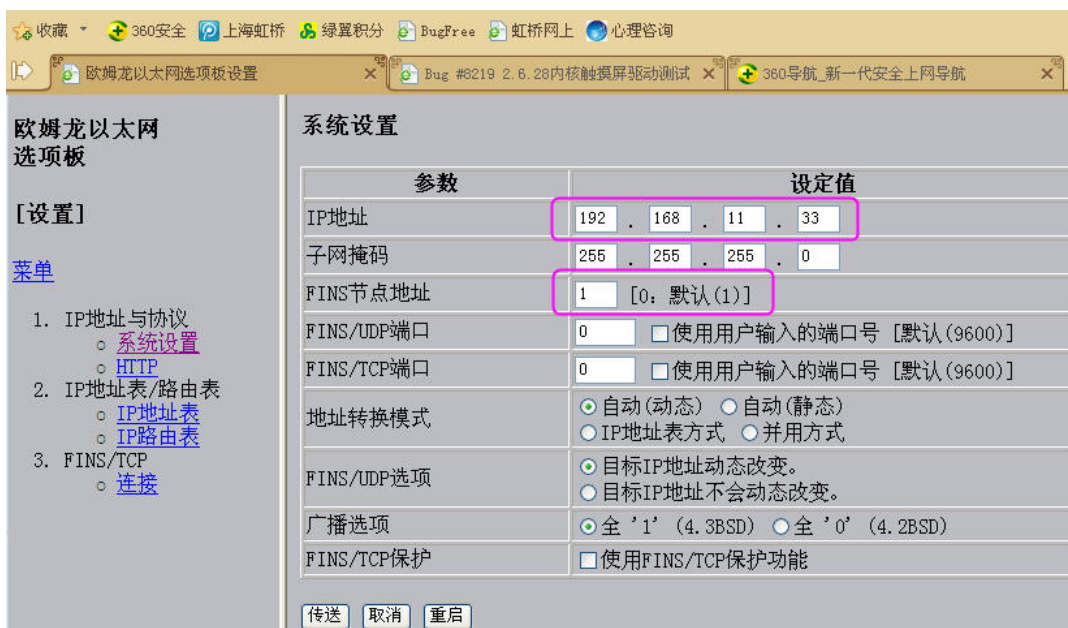

## OMRON NJ\_NX Series EtherNet\_IP(Free tag Names)

### HMI Setting

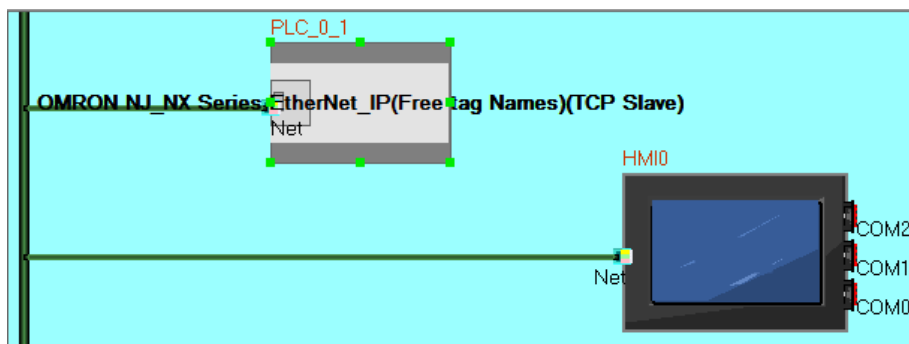

Device	IP Addr	Port	Protocol	Master/S...	Station...	Virtual ...
HMIO	192.168.250.137	48898	OMRON NJ...	M		
PLC_0_1	192.168.250.1	48898	OMRON NJ...	S	1	

### PLC Setting

#### ① Communication settings

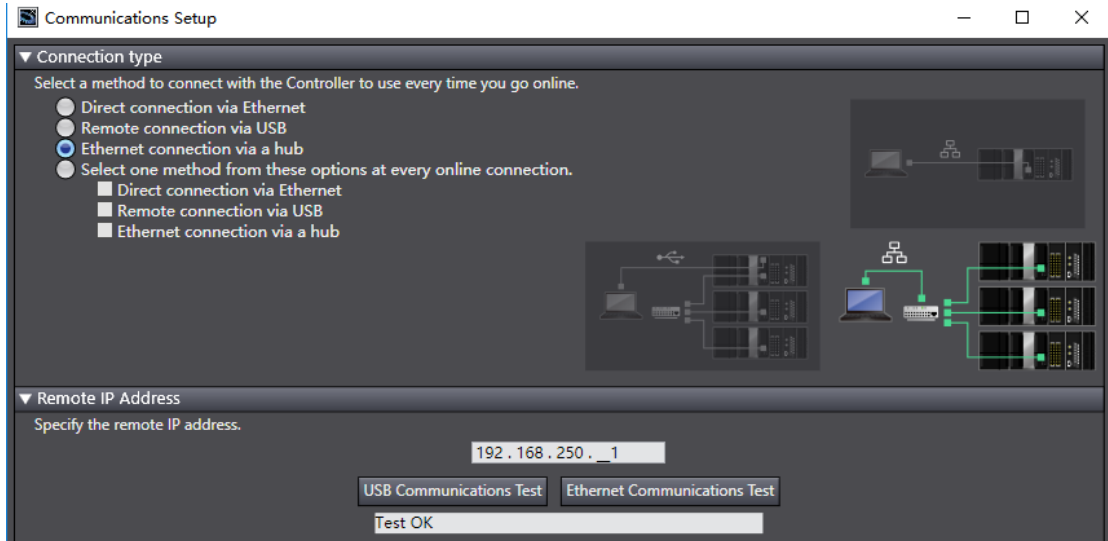

② IP address setting

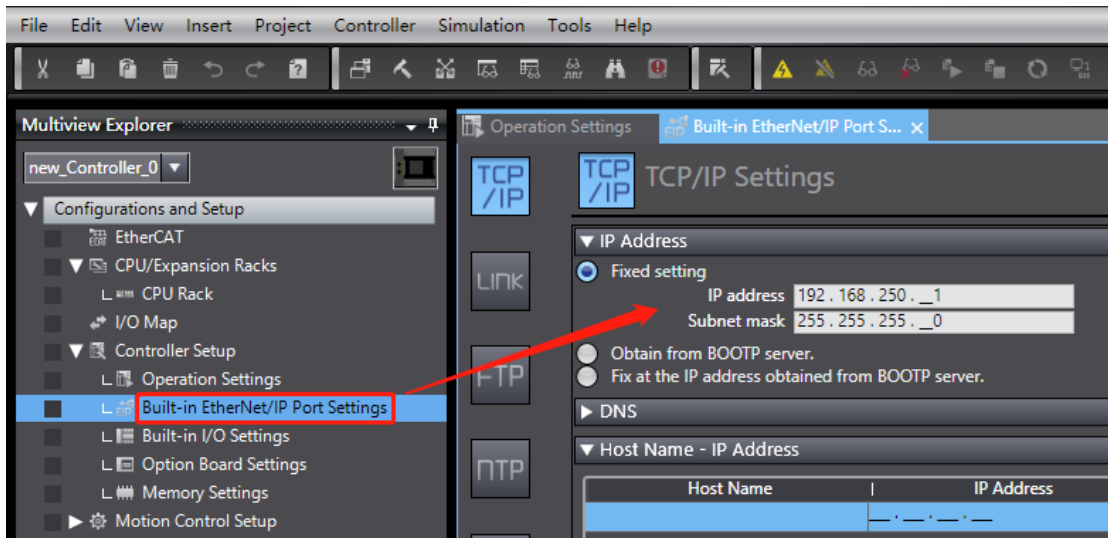

③ Enable memory settings

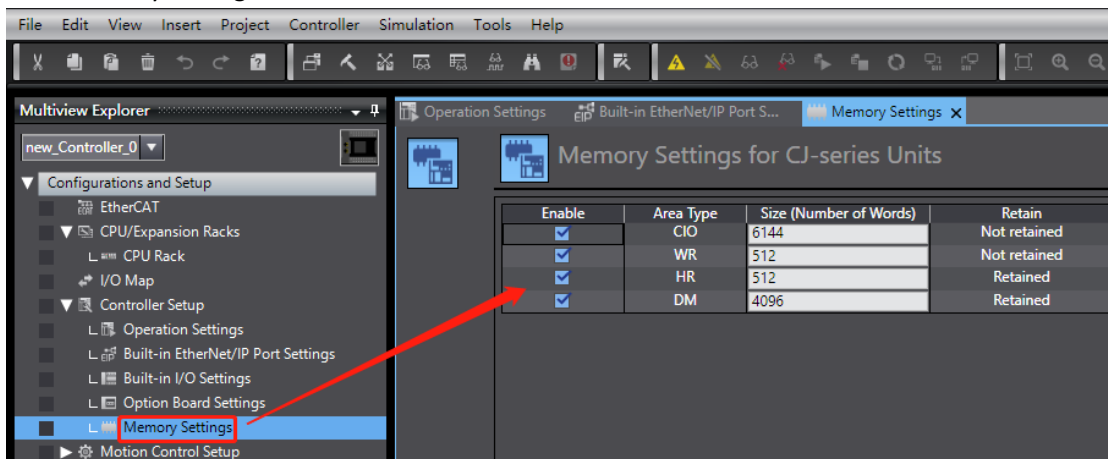

Note: NX series controllers, to enable memory settings; NJ series has no memory settings, do not need to be enabled.

④ Create variable tags

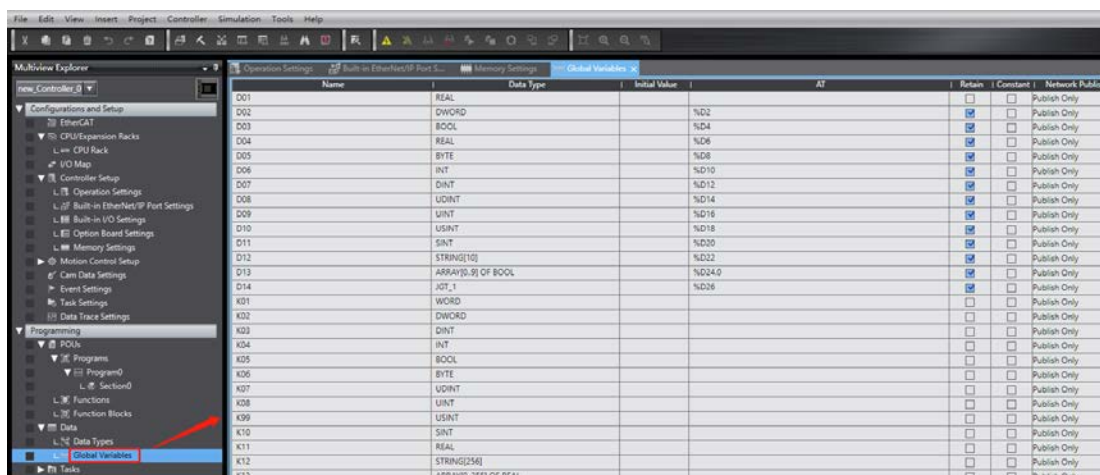

Note: The network public must be selected to be public only.

### Import Label

After the global variables of the sysmac Studio programming software are created, you can copy the global variables to the pasteboard by exporting the global variables and paste them directly into Kinco Dtools.

- ① Export global variables from plc software, copy global variables to clipboard

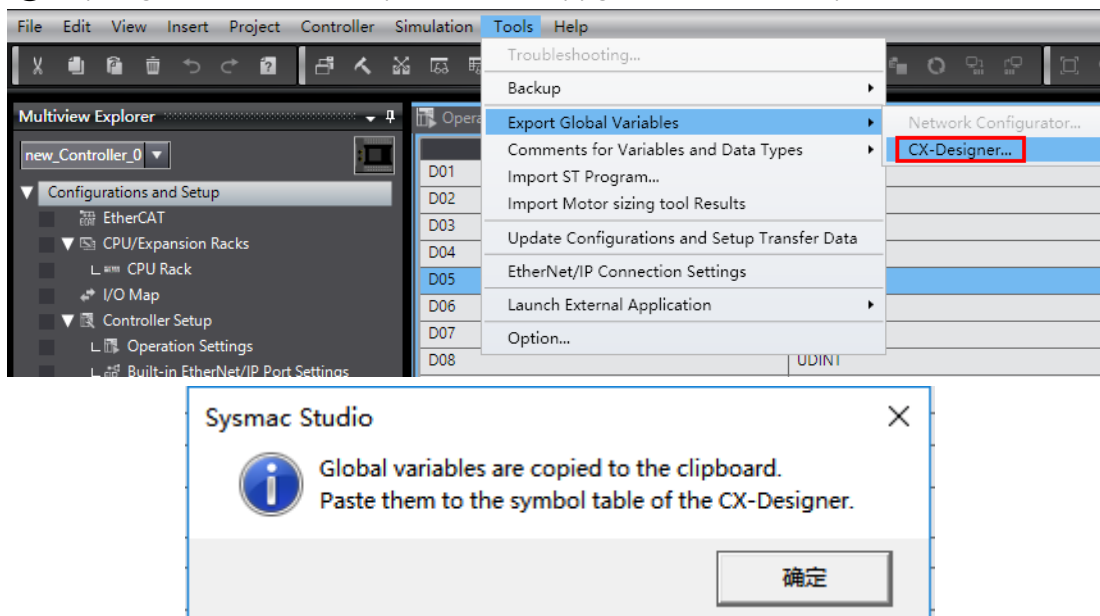

- ② Open the tag editor of the PLC property, paste the variable exported in ① and click OK. The tag is successfully created.

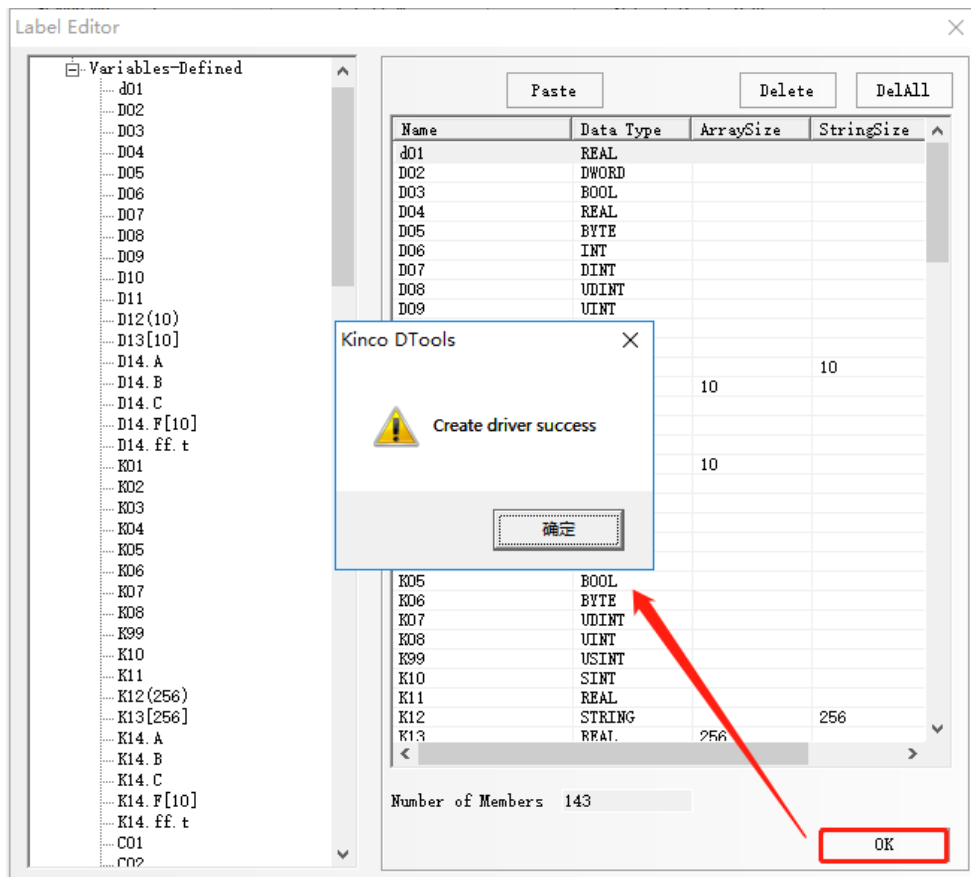
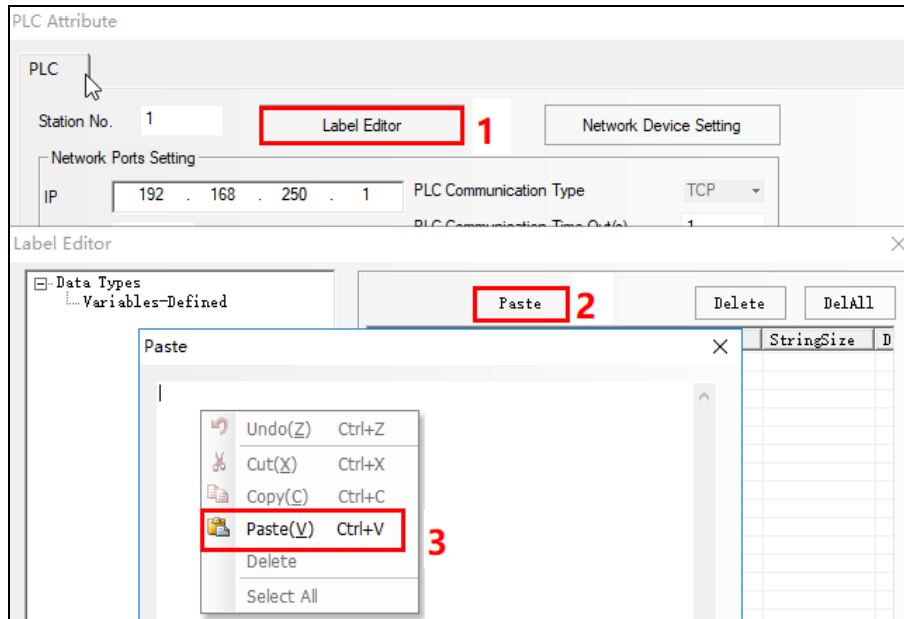

© Supported Device

Omron C Series Host Link

Device	Bit Address	Word Address	Format
Hold Relay	H_bit 00.00-99.15	-----	DD.DD
Data Relay	D_bit 0000.00-6655.15	-----	DDDD.DD

Link Relay	LR_bit 00.00-63.15	-----	DD.DD
Auxiliary Relay	A_bit 00.00-27.15	-----	DD.DD
Channel I/O	CIO_IR_bit 000.00-511.15	-----	DDD.DD
	C_FLAG 0-511	-----	DDD
	T_FLAG 0-511	-----	DDD
Counter Relay	-----	C 000-511	DDD
Timer Relay	-----	T 000-511	DDD
Hold Register	-----	H 00-99	DD
Data Register	-----	D 0000-6655	DDDD
Link Register	-----	LR 00-63	DD
Auxiliary Register	-----	A 0-27	DDD
Channel I/O Register	-----	CIO_IR_word 000-511	DDD

#### OMRON CP Series Host Link

Device	Bit Address	Word Address	Format	Notes
Work Relay	W_bit 0.00-511.15	-----	DDD.DD	
Hold Relay	H_bit 0.00-1535.15	-----	DDDD.DD	
Data Relay	D_bit 0.00-32767.15	-----	DDDDD.DD	
Counter Relay	C flag 0-4095	-----	DDDD.DD	
Timer Relay	T flag 0-4095	-----	DDDD.DD	
Auxiliary Relay	A_bit 0.00-959.15	-----	DDD.DD	
Channel I/O	CIO_bit 0.00-6143.15	-----	DDDD.DD	
	T_bit 0.00-4095.15	-----	DDDD.DD	
	C_bit 0.00-4095.15	-----	DDDD.DD	
Work Register	-----	W_word 0-511	DDD	
Hold Register	-----	H_word 0-1535	DDDD	
Data Register	-----	D_word 0-32767	DDDDD	
Counter Register	-----	C_word 0-4095	DDDD	
Timer Register	-----	T_word 0-4095	DDDD	
Auxiliary Register	-----	A_word 0-959	DDD	
Channel I/O Register	-----	CIO_word 0-6143	DDDD	
Byte Register		TK 0-31	DD	
		DR 0-15	DD	

#### OMRON CPM Series Host Link

Device	Bit Address	Word Address	Format	Notes
Hold Relay	HR 0.00-4095.15	-----	DDDD.DD	
Link Relay	LR 0.00-4095.15	-----	DDDD.DD	
Auxiliary Relay	AR 0.00-4095.15	-----	DDDD.DD	
Internal Relay	IR 0.00-4095.15	-----	DDDD.DD	
Timer/Counter Register	-----	TC 0-255	DDD	
Data Register	-----	DM 0-9999	DDDD	

**OMRON CJ/CS Series Host Link**

Device	Bit Address	Word Address	Format
Channel I/O	CIO 0.00-6143.15	-----	DDDD.DD
Internal Auxiliary Relay	W_bit 0.00-511.15	-----	DDD.DD
Special Auxiliary Relay	A_bit 0.00-11535.15	-----	DDD.DD
Latch Relay	H_bit 0.00-1535.15	-----	DDD.DD
Timer (Timer Up Flag)	T_FLAG 0-4095	-----	DDDD
Counter (Counter Up Flag)	C_FLAG 0-4095	-----	DDDD
Data Memory	D_bit 0.00-32767.15	-----	DDDDD.DD
Extension Data Memory Relay(E0-EF)	E0 0.00-E18 32767.15	-----	DDDDD.DD
Extension Data Memory(E0-EF)	-----	E0 0-E18 32767	DDDDD
Channel I/O	-----	CIO 0000-6143	DDDD
Internal Auxiliary Relay	-----	W 0-511	DDD
Special Auxiliary Relay	-----	A 0-11535	DDD
Latch Relay	-----	H 0-1535	DDD
Timer (current Value)	-----	T 0-4095	DDDD
Counter (Current Value)	-----	C 0-4095	DDDD
Data Memory	-----	D 0-4095	DDDDD
Index Register	-----	IR 00-15	DD
Data Register	-----	DR 00-15	DD

**OMRON CJ Series Ethernet (TCP Slave)**

Device	Bit Address	Word Address	Format
Channel IO	CIO 0.00-6143.15	-----	DDDD.DD
Internal Auxiliary Relay	W 0.00-511.15	-----	DDD.DD
Special Auxiliary Relay	A 0.0-959.15	-----	DDD.DD
Latch Relay	H 0.0-511.15	-----	DDD.DD
Timer Up Flag	T 0-4095	-----	DDDD
Count Up Flag	C 0-4095	-----	DDDD
TKB	TKB 0-127	-----	DD
	D0.00-32767.15		DDDDD.DD
	E0 0.00 - E18 32767.15		DDDDD.DD
Channel IO	-----	CIO 0-6143	DDDD
Byte Register	-----	DR 0-15	DD
Byte Register	-----	TK 0-127	DDD
Internal Auxiliary Relay	-----	W 0-511	DDD
Special Auxiliary Relay	-----	A 0-11535	DDD
Latch Relay	-----	H 0-1535	DDD
Timer Current Value	-----	T 0-4095	DDDD
Counter Current Value	-----	C 0-4095	DDDD
Extension Data Memory(E0-E18)	-----	E0-E18 0-32767	DDDDD
EM	-----	EM 0-32767	DDDDD
Index Register	-----	IR 0-15	DD
Data Register	-----	D 0-32767	DDDDD

**OMRON CJ/CS/NJ Series Ethernet (UDP Slave)**

Device	Bit Address	Word Address	Format
Channel IO 0.00-6143.15	CIO_bit	-----	DDDD.DD
	CIO_FORCE	-----	
	CIO_FORCE_RELEASE	-----	
	CIO_RELEASE_STATUS	-----	
Internal Auxiliary Relay 0.00-511.15	W_bit	-----	DDD.DD
	W_FORCE	-----	
	W_FORCE_RELEASE	-----	
	W_RELEASE_STATUS	-----	
Latch Relay 0.0-1535.15	H_bit	-----	DDDD.DD
	H_FORCE	-----	
	H_FORCE_RELEASE	-----	
	H_RELEASE_STATUS	-----	
Timer Up Flag 0-4095	T_FLAG	-----	DDDD
	T_FORCE	-----	
	T_FORCE_RELEASE	-----	
	T_RELEASE_STATUS	-----	
Count Up Flag 0-4095	C_FLAG	-----	DDDD
	C_FORCE	-----	
	C_FORCE_RELEASE	-----	
	C_RELEASE_STATUS	-----	
Special Auxiliary Relay	A 0.0-11535.15	-----	DDDDD.DD
Extension Data Memory 0.00-32767.15	E (0-9) _bit	-----	DDDDD.DD
	E (A-F) _bit	-----	DDDDD.DD
	E (10-18) _bit	-----	DDDDD.DD
Data Memory	D_bit 0.00-32767.15	-----	DDDDD.DD
TKB	TK_FLAG 0-127	-----	DDD
Channel IO	-----	CIO 0-6143	DDDD
Internal Auxiliary Relay	-----	W 0-511	DDD
Latch Relay	-----	H 0-1535	DDDD
Timer Current Value	-----	T 0-4095	DDDD
Counter Current Value	-----	C 0-4095	DDDD
Special Auxiliary Relay	-----	A 0-11535	DDDDD
Extension Data Memory	-----	E0-E9 0-32767 EA-EF 0-32767 E10-E18 0-32767 EM 0-32767	DDDDD
Data Memory	-----	D 0-32767	DDDDD
TK	-----	TK0-127	DDD
Index Register	-----	IR 0-15	DD
Data Register	-----	DR 0-15	DD



**OMRON CP Series Ethernet (UDP Slave)**

Device	Bit Address	Word Address	Format
Channel IO 0.00-6143.15	CIO_bit	-----	DDDD.DD
	CIO_FORCE	-----	
	CIO_FORCE_RELEASE	-----	
	CIO_RELEASE_STATUS	-----	
Internal Auxiliary Relay 0.00-511.15	W_bit	-----	DDD.DD
	W_FORCE	-----	
	W_FORCE_RELEASE	-----	
	W_RELEASE_STATUS	-----	
Latch Relay 0.0-1535.15	H_bit	-----	DDDD.DD
	H_FORCE	-----	
	H_FORCE_RELEASE	-----	
	H_RELEASE_STATUS	-----	
Timer Up Flag 0-4095	T_FLAG	-----	DDDD
	T_FORCE	-----	
	T_FORCE_RELEASE	-----	
	T_RELEASE_STATUS	-----	
Count Up Flag 0-4095	C_FLAG	-----	DDDD
	C_FORCE	-----	
	C_FORCE_RELEASE	-----	
	C_RELEASE_STATUS	-----	
Special Auxiliary Relay	A 0.0-959.15	-----	DDDDD.DD
Data Memory	D_bit 0.00-32767.15	-----	DDDDD.DD
TKB	TK_FLAG 0-31	-----	DDD
Channel IO	-----	CIO 0-6143	DDDD
Internal Auxiliary Relay	-----	W 0-511	DDD
Latch Relay	-----	H 0-1535	DDDD
Timer Current Value	-----	T 0-4095	DDDD
Counter Current Value	-----	C 0-4095	DDDD
Special Auxiliary Relay	-----	A 0-959	DDDDD
Data Memory	-----	D 00000-32767	DDDDD
TK	-----	TK0-31	DDD
Index Register	-----	IR 0-15	DD
Data Register	-----	DR 0-15	DD

**OMRON NJ\_NX Series EtherNet\_IP (Free tag Names)**

Date Type	data format	Notes
Bool	bit	
Byte	16-bit Decimal, Hex, Binary	8-bit

SInt	16-bit Decimal, Hex, Binary	8-bit
USInt	16-bit Decimal, Hex, Binary	8-bit
Word	16-bit Decimal, Hex, Binary	16-bit
Int	16-bit Decimal, Hex, Binary	16-bit
UInt	16-bit Decimal, Hex, Binary	16-bit
DWord	32-bit Float,Decimal, Hex, Binary	32-bit
DInt	32-bit Float,Decimal, Hex, Binary	32-bit
Real	32-bit Float,Decimal, Hex, Binary	32-bit
UDInt	32-bit Float,Decimal, Hex, Binary	32-bit
Array		

### © Cable Diagram

#### RS232 Communication Cable

##### 1. RS232 on the CPU unit or CP1W-CIF01\CS1W-SCU21\CS1W-SCB21 etc. module

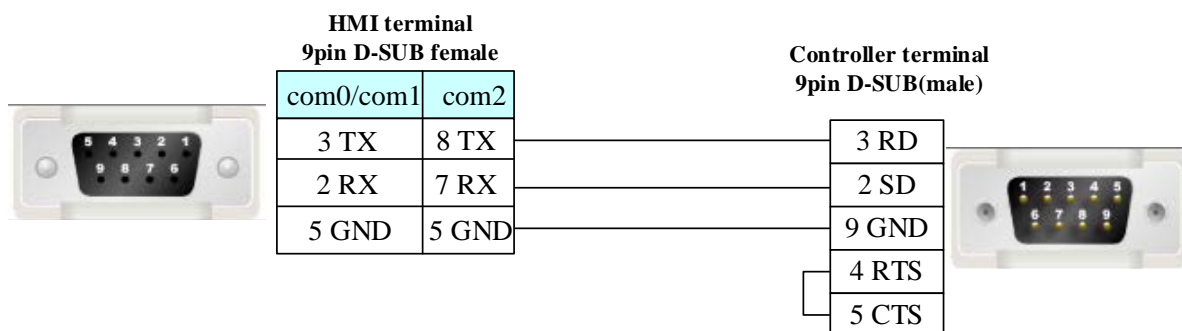

##### 2. Peripheral port on the CPU unit (OMRON CJ\CS series)

When connecting the peripheral port on the CPU by the conversion adapter, set DIP4 to on.

#### RS422 Communication Cable

##### 1. CJ1W-SCU41\ CJ1W-SCB41 module

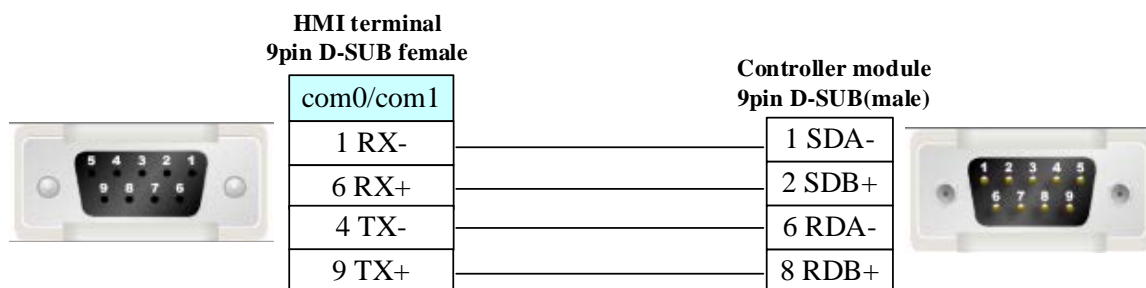

##### 2. CP1W-CIF11/CP1W-CIF12 module

**NOTE:** CP1W-CIF11 is without photoelectricity isolation, the maximum communication distance is 50 m.

CP1W-CIF12 is with photoelectricity isolation, the maximum communication distance is 500 m. Other parameters specification and DIP switch settings are the same.

DIP	CONTENT		
1	ON	Yes (Both sides)	Terminal resistance selection
	OFF	No	
2	ON	2-wires (RS485)	2、3 must be the same.
	OFF	4-wires (RS422A)	
3	ON	2-wires (RS485)	
	OFF	4-wires (RS422A)	
4	-----	-----	N/A
5	ON	With RS control	Set ON when loop back is forbidden.
	OFF	Without RS control (Receive)	
6	ON	With RS control	If connecting to multiple devices, set ON when using RS422A, it must set as ON.
	OFF	Without RS control (Send)	

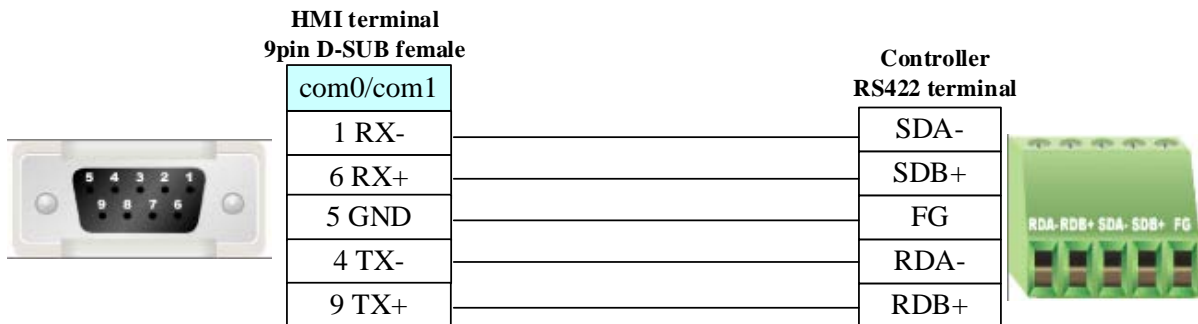

**NOTE:** When PLC uses CP1W-CIF11 or CP1W-CIF12 module for communication, if it uses 1:1 and RS422 communication, it need to set all the DIP Switch SW1~6 as OFF. If it uses 1:N and RS422 communication, it need to set DIP Switch SW1~5 as OFF and SW6 as ON.

**RS485 communication cable**

**CP1W-CIF11/CIF12 module**

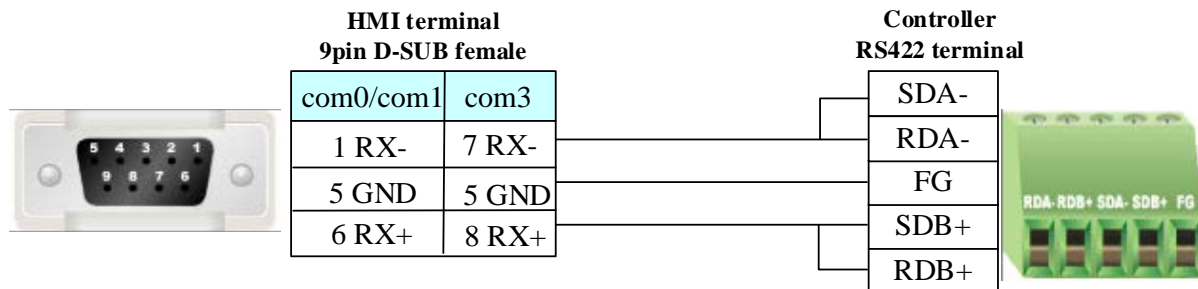

**NOTE:** When PLC uses CP1W-CIF11 or CP1W-CIF12 module and RS485 communication, please make sure the DIP Switch SW1 of CP1W-CIF11 or CP1W-CIF12 as OFF, and set SW2,SW3,SW5,SW6 as ON.SW4 can be set as ON or OFF.

**Ethernet communication protocol cable**

Cross-connection or crossover network cable can be used as communication cable via the hub  
Refer to [3.3 Download by Network Ethernet](#) for method of making connection cable.

## 4.60 OMRON E5EZ-R3(Temperature Controller)

### ◎ Serial Communication

Series	CPU	Link Module	Driver
OMRON E5EZ-R3	E5EZ-R3 E5EZ-C3MT	RS485 on the CPU unit	Omron E5EZ-R3

### ◎ System configuration

Series	CPU	Link Module	COMM Type	Parameter	Cable
OMRON E5EZ-R3	OMRON E5EZ-R3	RS485 on the CPU unit	RS485	<a href="#">Setting</a>	<a href="#">Your owner cable</a>

### ◎ Communication Setting

Default communication: 9600, 7, even, 2; station: 0

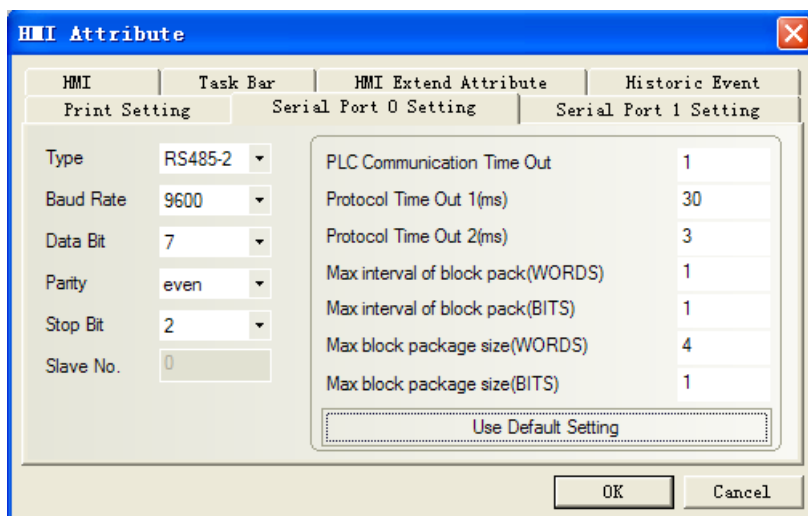

### ◎ Supported Device

#### OMRON E5EZ-R3

Device	Bit Address	Word Address	Format	Notes
Variable	-----	0.0 — 0.A (C0 read only)	DDD.HH	Main addr indicates variable type 0(C0),1(C1),2(C3) subaddress indicates address of variable type
		1.0 — 1.2D (C1)		
		2.0 — 2.5B (C3)		
Action Command	-----	0-8	H	
State	0-31	-----	DD	Show the bit value of 0001

				(state) in C0
Abnormal Input	0	-----	D	The 6th value of C0 0001(state) Abnormal Input

**NOTE:** H indicates hexadecimal

**Action Command address and other informations**

Addr	command	content	Notes
0	Communication write	00:OFF (disable)	Before writing data, "Communication write" command is "01" ON (enable)", otherwise it writes disable
		01:ON (enable)	
1	Run/Stop	00: Run	
		01: Stop	
2	Multi-segment SP	00: Setting value 0	Must set the value of variable(addr:3.1A )to 1(ON) for writing correctly, otherwise it can't write-in.
		01: Setting value 1	
		02: Setting value 2	
		03: Setting value 3	
3	AT execute/stop	00: stop	
		01: AT execute	
4	write-in mode	00: save	
		01: RAM	
5	RAM storage	00	
6	Soft reset	00	
7	Setting area1 shift	00	
8	Protection value shift	00	

**Please refer to the communication protocol for details.**

**NOTE:**

- Make sure the setting value be the same as the plc's station No.
- Must be the same as the station No. of HMI
- Before writing data, "Communication write" command must is "01" ON (enable)", otherwise it writes disable

**© Cable Diagram**

**RS485 communication cable**

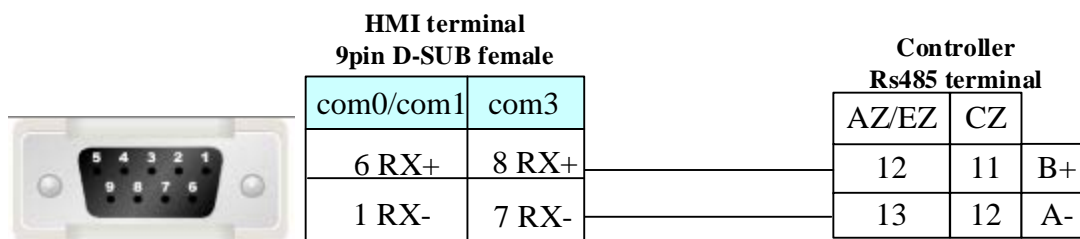

**RS232 communication, need to use RS-232 to RS-422/485 converter**

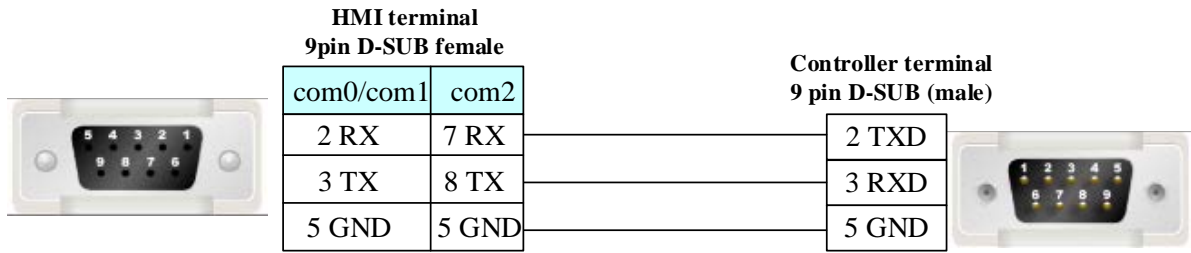

### 4.61 OPTO 22

#### ◎ Ethernet Communication (nonsupport Direct Online Simulation)

Series	CPU	Link Module	Driver
OPTO 22	SNAP-UP1-ADS SNAP-PAC-R2	Ethernet	OPTO 22 SNAP Ethernet(TCP)

#### ◎ System configuration

Series	CPU	Link Module	Connect Type	Parameter	Cable
OPTO 22	SNAP-UP1-ADS SNAP-PAC-R2	Ethernet	Ethernet	<a href="#">Setting</a>	<a href="#">Your owner cable</a>

#### ◎ Communication Setting

Device	IP Addr	Port	Protocol	M...	Station...	Virtual P...
HMI0	192.168.1.15	22001	OPTO 22 SNAP Ethernet(TCP)	M		
PLC_0_1	192.168.1.10	22001	OPTO 22 SNAP Ethernet(TCP Slave)	S	1	

### PLC Settings

Use Manager tool to read/write IP of OPT controller

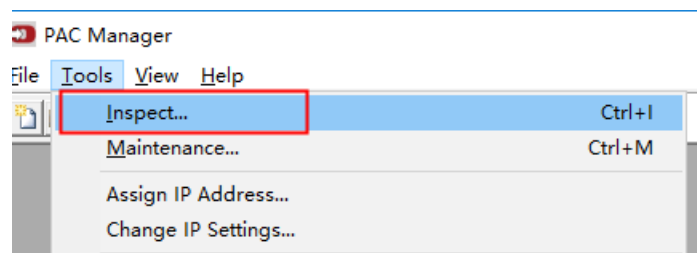

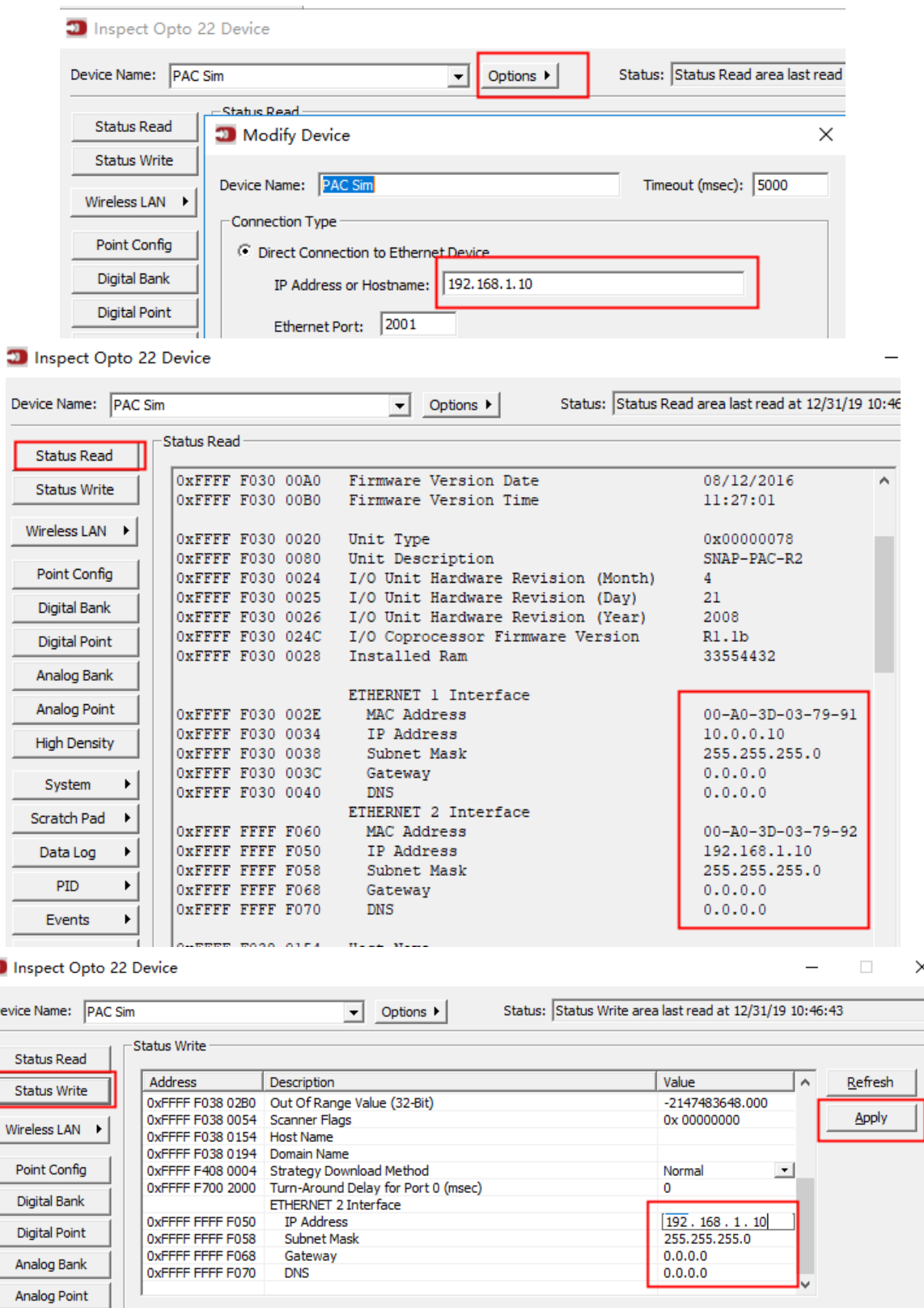

**PLC Software Setting**

Set the IP of OPT to connect with Software

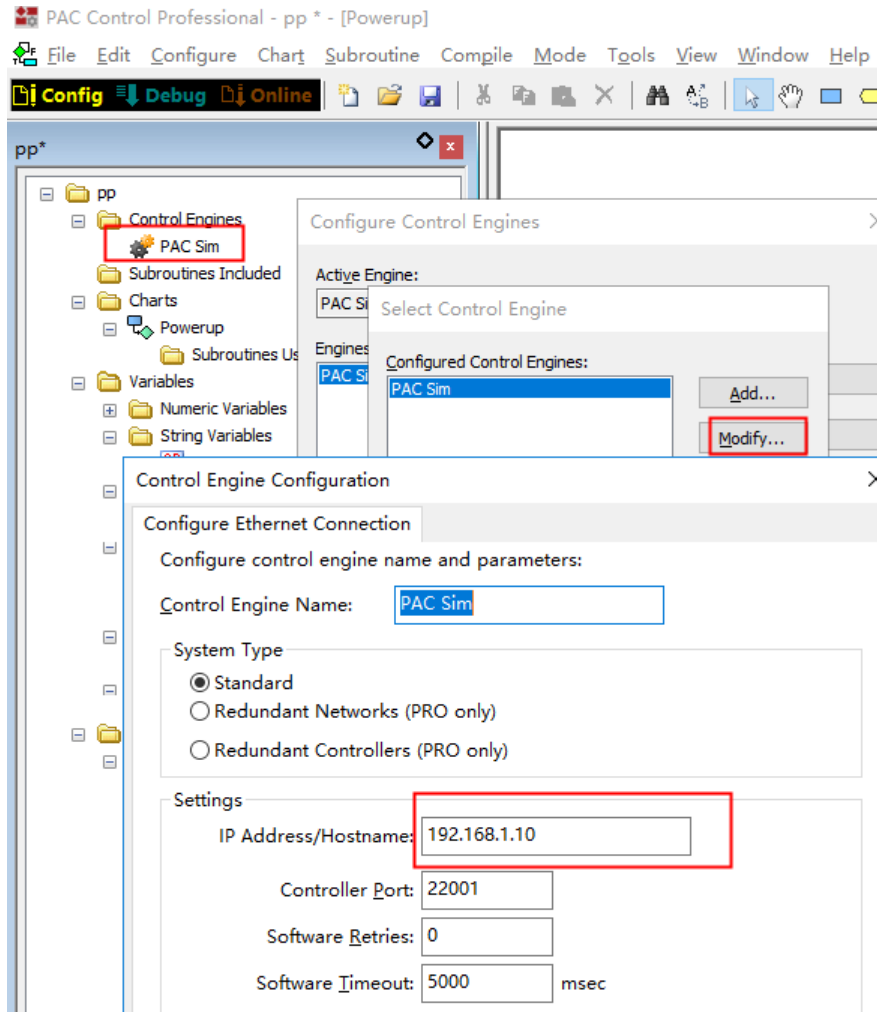

**Register add setting**

Click “Config” to edit mode

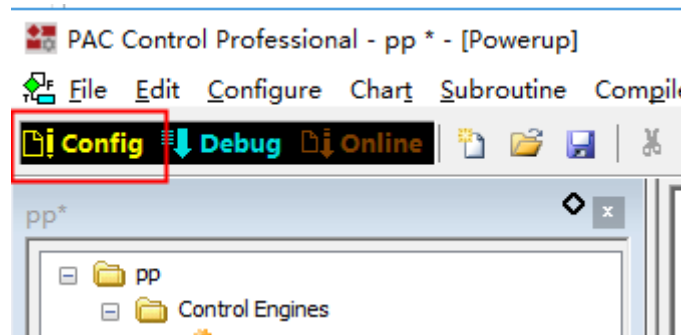

**Non-array type addition:**

1.”B “or “N” bit register adding:chose Integer 32 Type



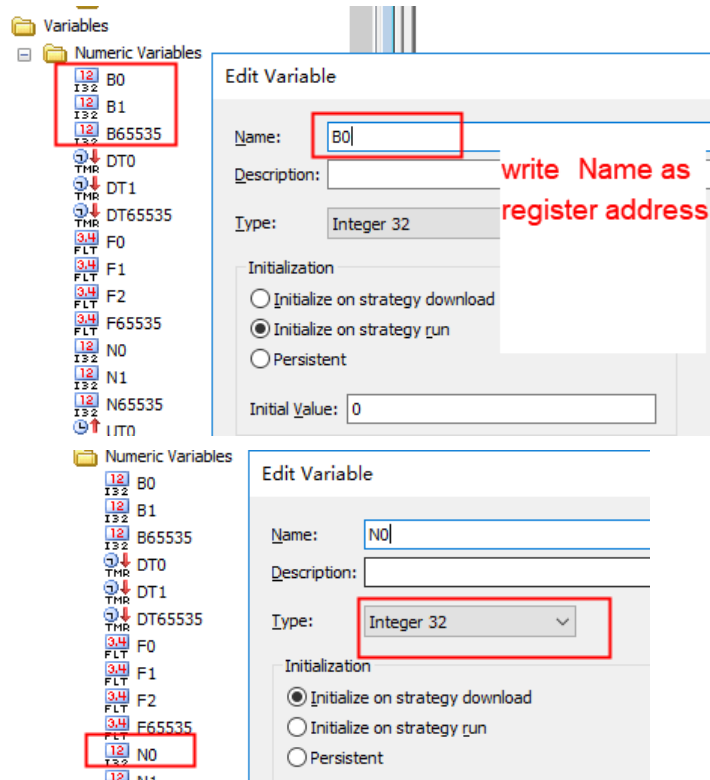

2."DT" register:chose Down Timer Type

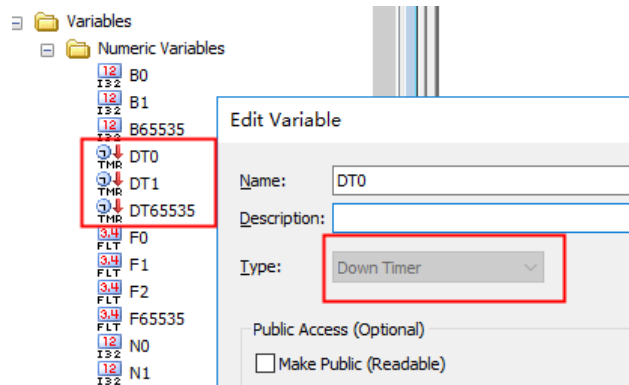

3."UT" register:chose UP Timer Type

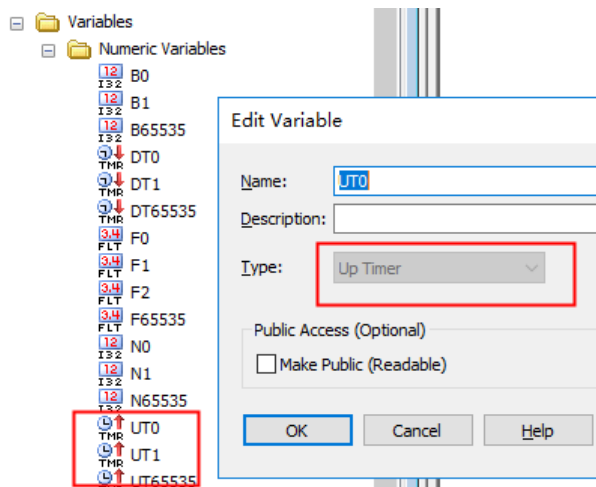

4."F" register:chose Float Type

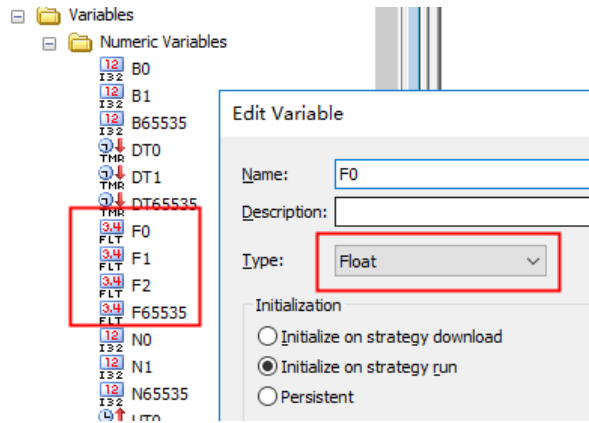

**Array table adding:**

**BT/FT/NT (register name) +array number, set array length; for example: BT0 length 50, BT1 length 50**

**1. BT bit array adding:**

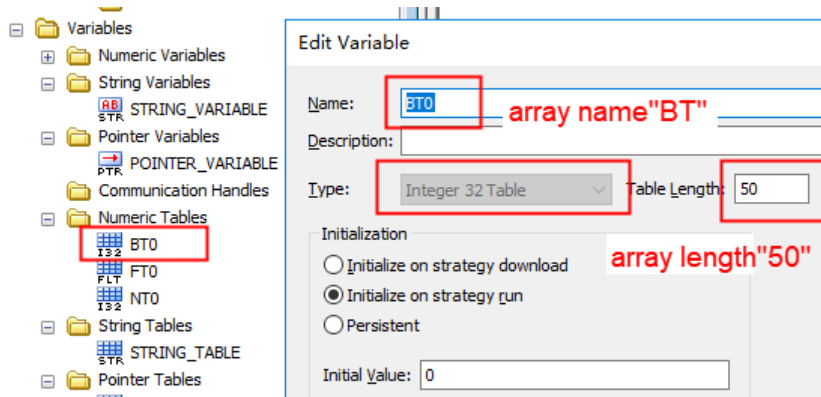

**2. Float array adding:**

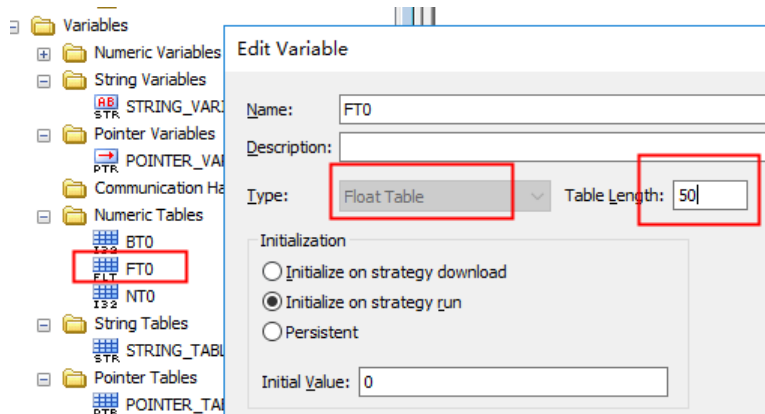

**3. INT array adding:**

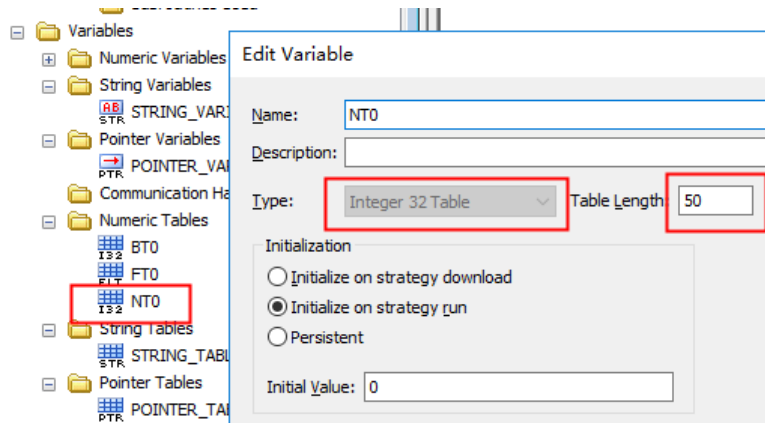

4.I/O bit register adding:

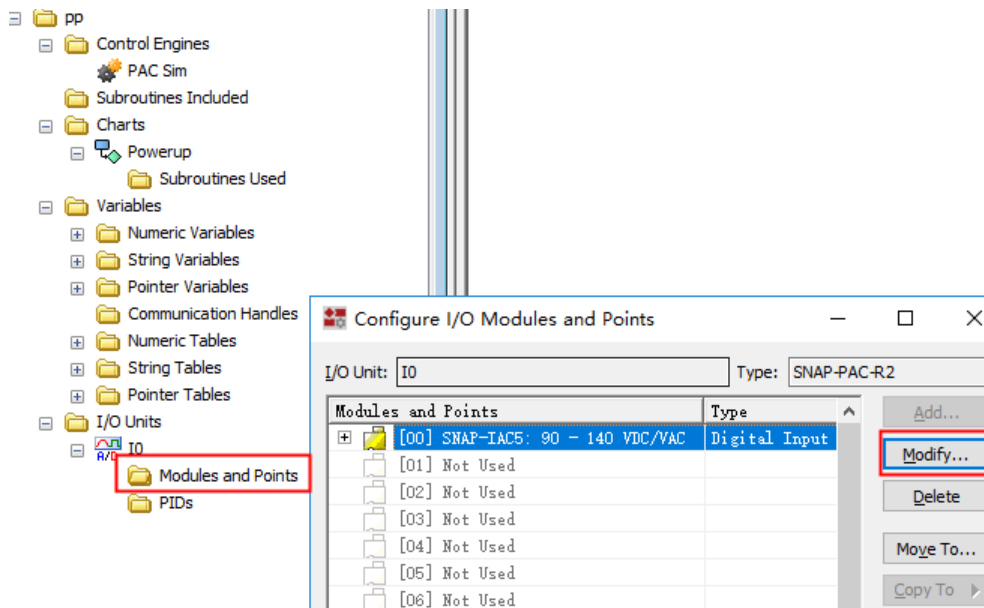

After adding register, click “Debug” to download project.

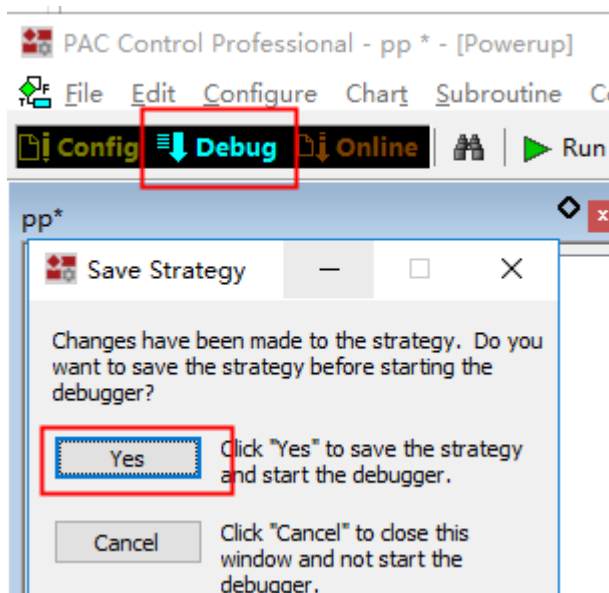

Watch variables’s value online

Write click “Watch”

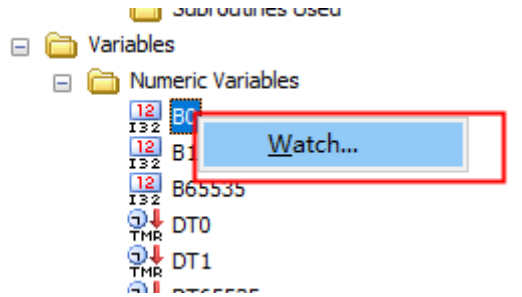

Click “New” to create a table as “5”

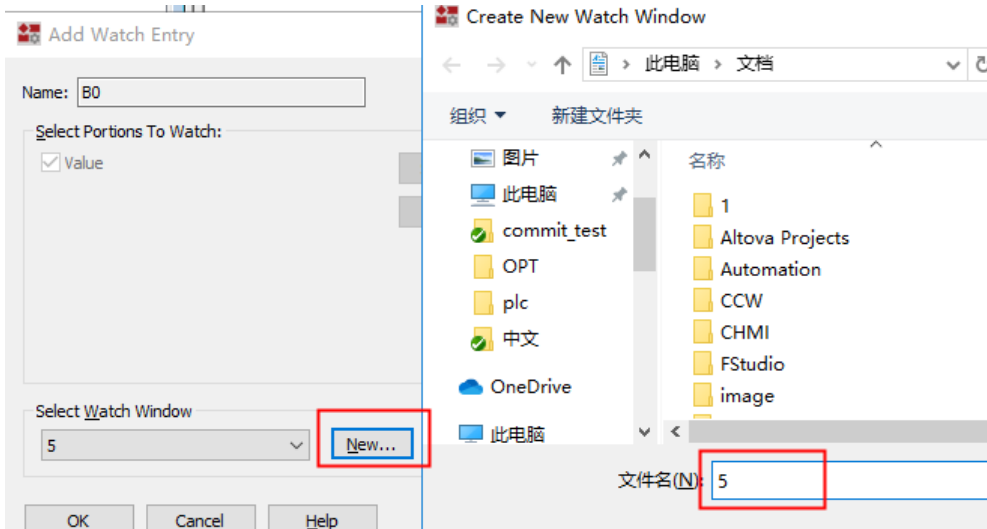

Then double click variables to change values, and click “Apply”

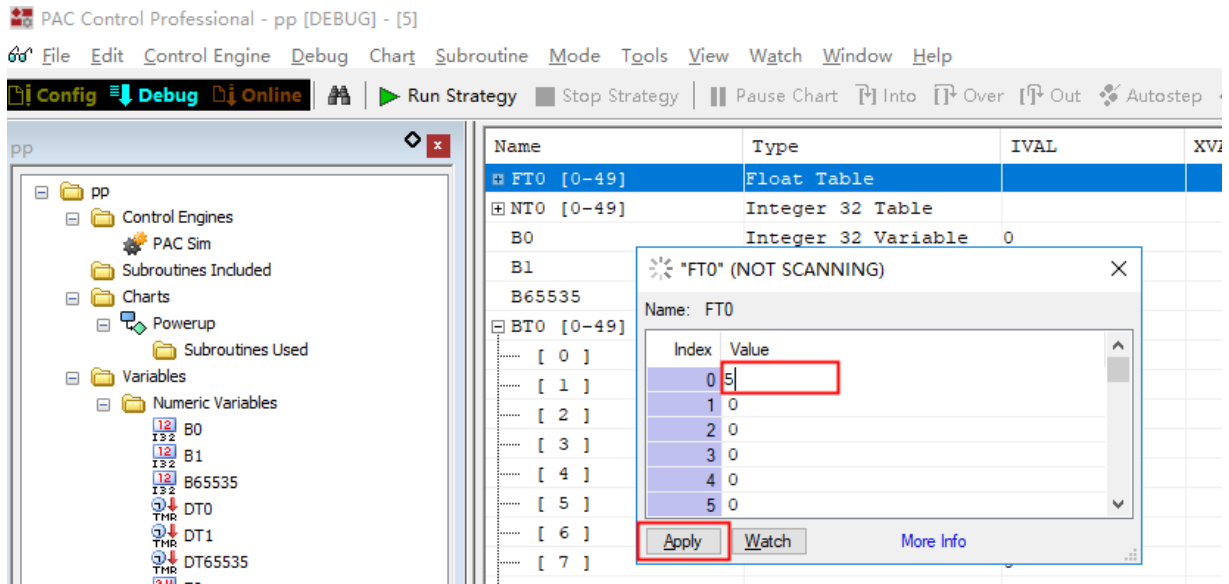

**Notice**

- The address set in OPTO 22 software and HMI configuration should be correspond :
  - Correct:** Define Float type like “F1” in OPTO 22 software  
Then it can communicate normally.  
Select the “FN” register in the HMI configuration, the address is: 1
  - Error:** Float type defined in OPTO 22 software such as “F0001”  
Select the FN register in the HMI configuration, the address is: 1

Then it cannot communicate normally.

## 2. Correspondence between array registers and HMI configuration

For example, configure “FTn 0.000” : The 0 before the decimal point represents the array number, which corresponds to the FT0 array in the PLC, the decimal point represents the address of each register in the array, and FTn0.049 corresponds to the address 49 in the FT0 array in the PLC.

Configuration FTn 1.000 corresponds to FT1 array, address 0; FTn1.049 corresponds to array FT1, address 49

Same for NTn and BTn

## ◎Supported Device

Device	Bit Address	Word Address	Format
Bit Table	B0-65535	---	DDDDD
Input Coil	In0-65535	--	DDDDD
Output Coil	Qn0-65535	--	DDDDD
Bit Table	BT0.000-65535.255	---	DDDDD.DDD
Integer 32	---	N32 0-65535	DDDDD
Float	---	FN0-65535	DDDDD
UP Timer	---	UTN0-65535	DDDDD
Down Timer	---	DTN0-65535	DDDDD
Integer 32 Table	---	NT0.000-65535.255	DDDDD.DDD
Float Table	---	FT0.000-65535.255	DDDDD.DDD

### Editing Macro, please refer to the type table:

Register	Type
N32	Double
FN	Float
DTN	Float
UTN	Float
IN	BIT
QN	BIT
NT	Double
FT	Float
B	BIT(the attribute of B is the same as N32 in the PLC software)
BT	BIT(the attribute of BT is the same as NT in the PLC software)

## ◎Cable Diagram

### Ethernet communication cable

Cross-connection or crossover network cable can be used as communication cable via the hub

Refer to [3.3 Download by Network Ethernet](#) for method of making connection cable.

## 4.62 Panasonic Electric Corporation

### ◎Serial Communication

Series	CPU	Link Module	Driver
FP	FP $\Sigma$	Tool port on the Control unit	Panasonic FP Panasonic FP_Extend
		AFPG801	
		AFPG802	
		AFPG803	
		AFPG806	
	FP0 FP1 FP-M	Tool port on the Control unit	
		RS232C port on the Control unit	
	FP2 FP2SH	Tool port on the Control unit	
		RS232C port on the Control unit	
		AFP2462	
		AFP2465+(AFP2803,AFP2804, FP2805)	
	FP3	Tool port on the Control unit	
		AFP3462	
	FP-e	Tool port on the Control unit	
		AFPE224300	
		AFPE224302	
		AFPE224305	
		AFPE214322	
		AFPE214325	
FP10SH FP10S	Tool port on the Control unit		
	RS232C port on the Control unit		
	AFP3462		
FP-X	RS232C port on the Control unit		
FP7	CPS3E	RS232 on the CPU unit	Panasonic FP7

### ◎Network Communication

Series	CPU	Link Module	Driver
FP	FP-X	Ethernet interface on CPU	Panasonic FP Ethernet (TCP Slave)
FP7	CPS3E	Ethernet interface on CPU	Panasonic FP7 Ethernet (TCP slave)

### ◎Serial System configuration

Series	CPU	Link Module	COMM Type	Parameter	Cable
FP	FP <input type="checkbox"/>	Tool port on the Control unit	RS232C	Setting	<a href="#">Your owner cable</a>
		AFPG801			<a href="#">Your owner cable</a>
		AFPG802			
		AFPG806			

		AFPG803	RS485(2 wire)	<a href="#">Setting</a>	<a href="#">Your owner cable</a>
		AFPG806			
FP0		Tool port on the Control unit	RS232C	<a href="#">Setting</a>	<a href="#">Your owner cable</a>
		RS232C port on the Control unit			
FP1 FP-M		Tool port on the Control unit	RS232C	<a href="#">Setting</a>	<a href="#">Your owner cable</a>
		RS232C port on the Control unit			
FP2 FP2SH		Tool port on the Control unit	RS232C	<a href="#">Setting</a>	<a href="#">Your owner cable</a>
		RS232C port on the Control unit			
FP2 FP2SH		AFP2462	RS422(4 wire)	<a href="#">Setting</a>	<a href="#">Your owner cable</a>
	AFP2465	AFP2803			
		AFP2804			
		AFP2805			
FP3		Tool port on the Control unit	RS232C	<a href="#">Setting</a>	<a href="#">Your owner cable</a>
		AFP3462			
		AFP3463			
FP-e		Tool port on the Control unit	RS232C	<a href="#">Setting</a>	<a href="#">Your owner cable</a>
		AFPE224300			
		AFPE214325			
		AFPE224305			
		AFPE224302			
FP10SH FP10S		Tool port on the Control unit	RS232C	<a href="#">Setting</a>	<a href="#">Your owner cable</a>
		RS232C port on the Control unit			
		AFP3462			
FP-X		RS232C port on the Control unit	RS232C	<a href="#">Setting</a>	<a href="#">Your owner cable</a>
FP7	CPS3E	RS232 on the CPU unit	RS232	<a href="#">Setting</a>	<a href="#">Your owner cable</a>

**NOTE:**

1. Only FP0 (C10CRM/C10CRS/C14CRM/C14CRS/C16T/C16CP/C32CT/C32CP) has RS232C port.
2. Only FP1 (C24/C40/C56/C72) has RS232C port.
3. Only FP1(C20R/C20T/C32T)has RS232C port.
4. AFP245 is the communication Package of FP2/FP2SH. AFP2803, AFP2084 and AFP2085 are the communications module of AFP2465.

### ◎ Network System configuration

Series	CPU	Link Module	COMM Type	Parameter	Cable
FP	FP-X	Ethernet interface on CPU	Ethernet	<a href="#">Setting</a>	<a href="#">Your owner cable</a>
FP7	CPS3E	Ethernet interface on CPU	Ethernet	<a href="#">Setting</a>	<a href="#">Your owner cable</a>

### ◎ Serial Communication Setting

Panasonic FP、Panasonic FP\_Extend protocol:  
[RS232 communication](#)

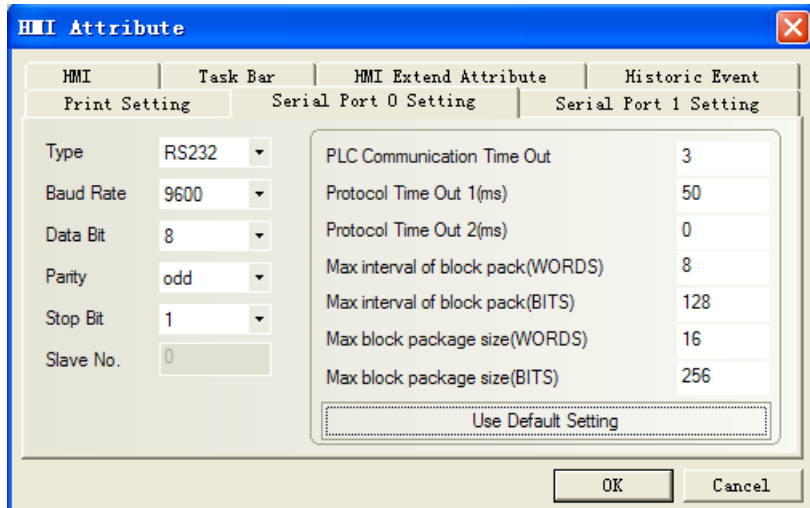

**Panasonic FP7 protocol:**

**HMI Setting**

Default communication parameters: 19200, 8, odd, 1; station: 1

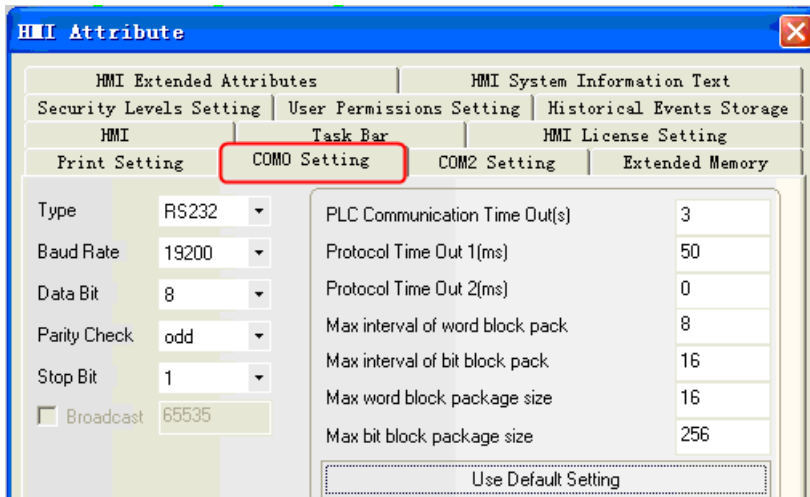

**PLC Setting**

communication parameters setting:

No	Item name	Data	Di...	Range	Additional information
768	Communication mode	MEWTOCOL-COM master...		MEWTOCOL...	The PLC can be a MEWTOCOL-COM mas
769	Station number	1		1 to 99	Station number (available in 'MEW
770	Baud rate	19200	baud	230400	Specifies the baud rate of the po
771	Sending data length	8 bits		8 bits	Selects the sending data length.
772	Sending parity check	Odd		None	Selects the parity check.
773	Sending stop bit	1 bit		1 bit	Specifies the number of stop bits
774	RS/CS control	Disable		Disable	
775	Sending delay time	0	ms	0 to 100	
776	Sending start code	No-STX		No-STX	Selects the start code (available
777	Sending end code/...	CR		CR	Selects the end code (available i
778	Reception done...	0	ms	0.0 to 1...	
779	Modem connection	Disable		Disable	Specifies if a modem is connected

© **Network Communication Setting**

**Panasonic FP Ethernet (TCP Slave) protocol**

**HMI Setting**



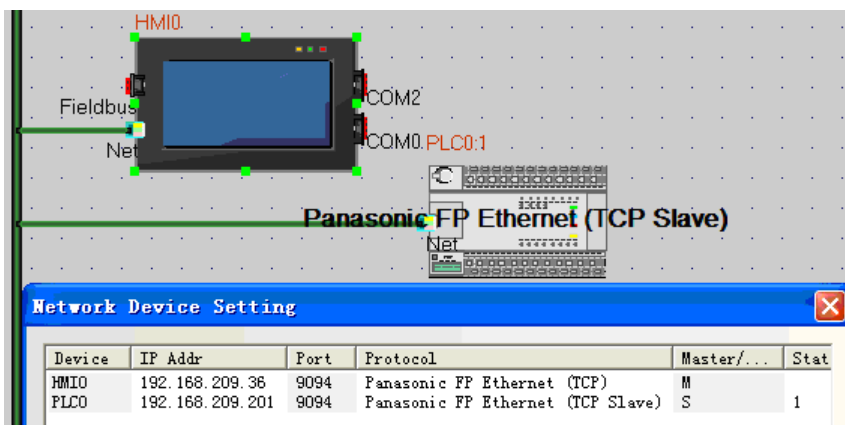

## PLC Setting

1. Open the Configurator WD and search the online PLC.

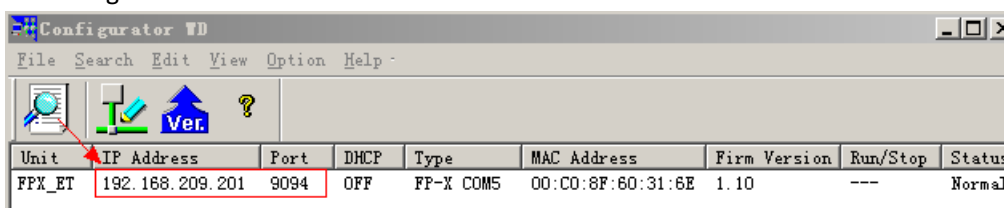

**NOTE:** Configurator WD can configure PLC parameters (IP Address, Port .....).

2. Software Setting

1) Open the Control FPCWIN Pro 7, build new project and select PLC type (FP-X C40T) ;

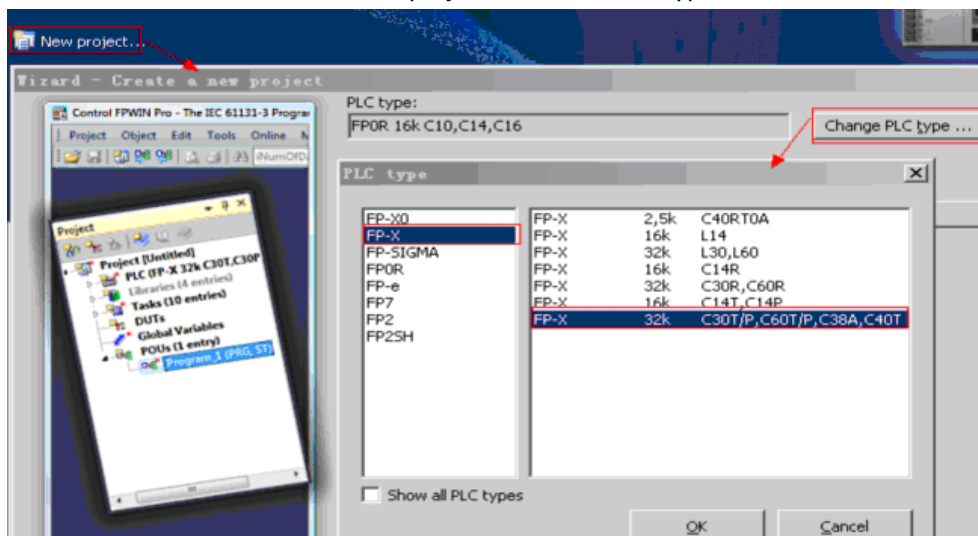

2) Communication setting: [Online] → [Communication parameters...] → Communications settings (Destination Parameters must be the same as the testing PLC Parameters)

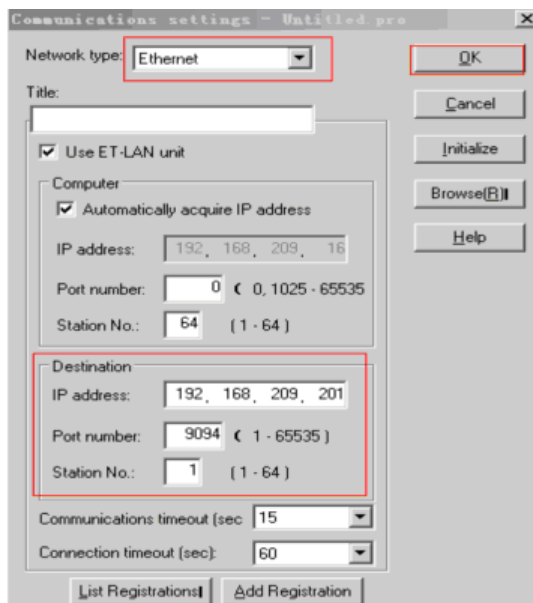

3) VAR\_EXTERNAL declaration

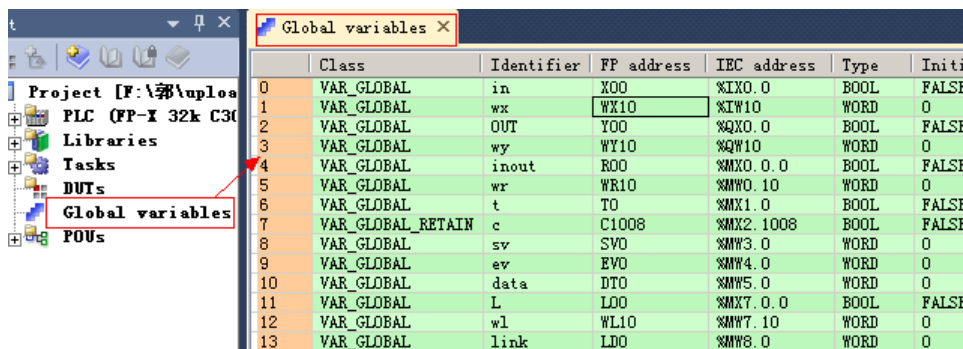

**NOTE:** VAR\_EXTERNAL must be declared; otherwise you will get some compile errors.

4) Download to the PLC

**Panasonic FP7 Ethernet (TCP Slave) protocol**

**HMI Settings**

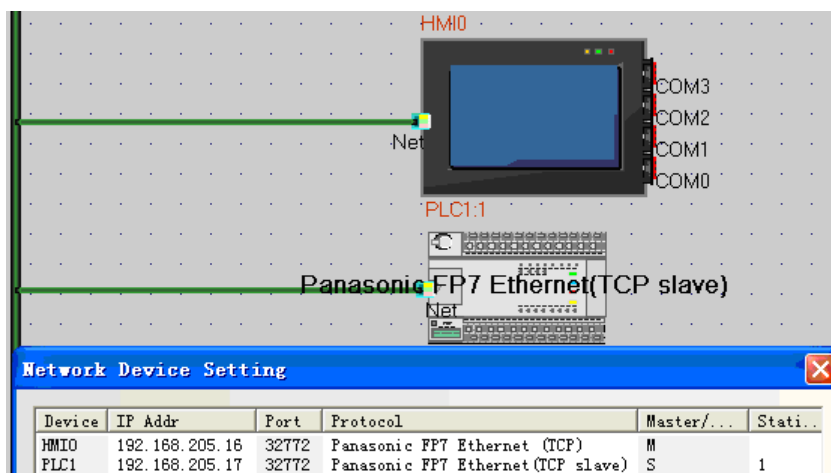

**NOTE:**

This protocol supports one HMI to one PLC communication.

## PLC Settings

### 1、communications settings

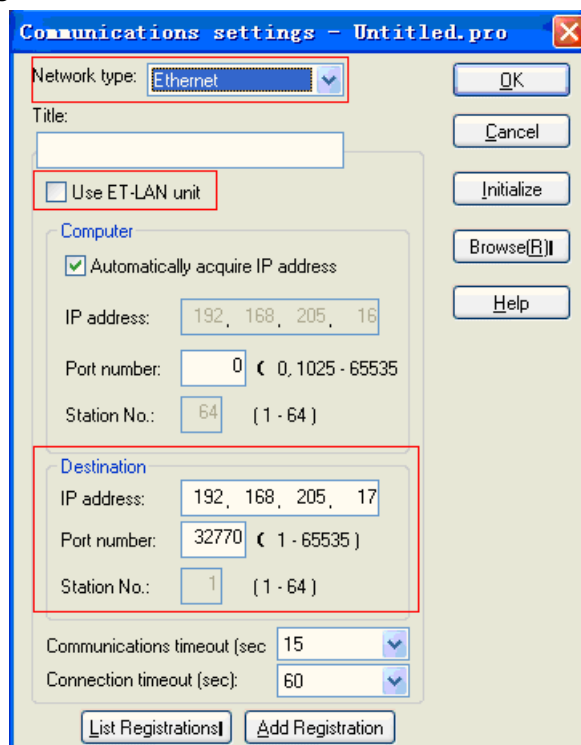

#### NOTE:

- a. The range of the destination's port number is 32769~32772.
- b. The destination's port number cannot be the same as the network device setting's port of HMI setting.

### 2、changed the IP address

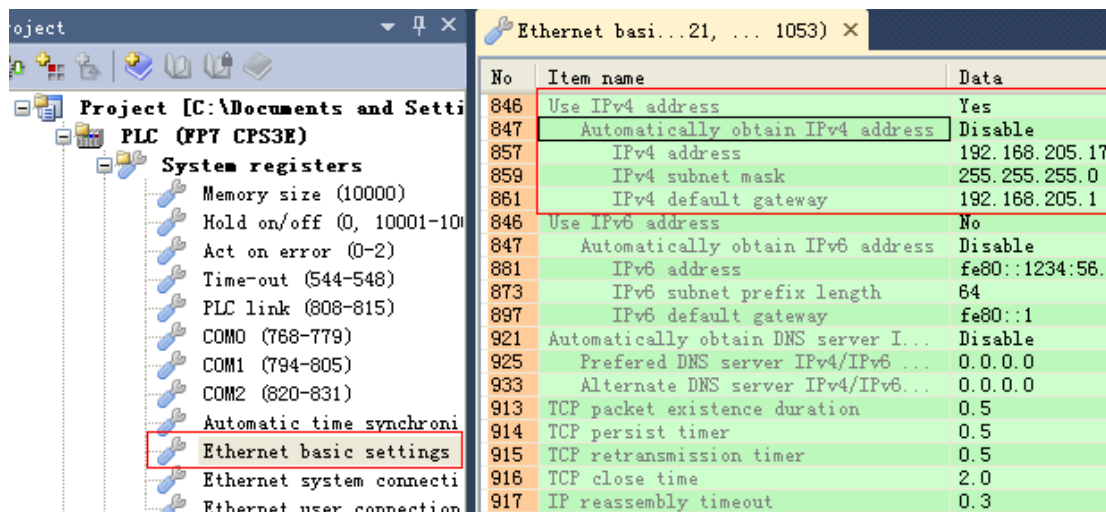

## © Supported Device

### Panasonic FP Series

Device	Bit Address	Word Address	Format	Notes
Output Relay	X0.0~32767.F	-----	DDDDD.H	
Input Relay	Y0.0~32767.F	-----	DDDDD.H	

Timer	T0~9999	-----	DDDD	
Counter	C0~9999	-----	DDDD	
Link Relay	L0.0~32767.F	-----	DDDDD.H	
Internal Auxiliary/Relay	R0.0~32767.F	-----	DDD.H	
T/C Elapsed Value	-----	EV0~32767	DDDDD	
T/C Setting Value	-----	SV0~9999	DDDD	
Data Register	-----	DT0~99999	DDDDD	
Input Word	-----	WX0~32767	DDDD	
Output Word	-----	WY0~32767	DDDD	
Internal Auxiliary/Relay	-----	WR0~32767	DDDDD	
Link Data Register	-----	LD0~99999	DDDDD	
Link Relay	-----	WL0~32767	DDDDD	
File Register	-----	FL0~99999	DDDDD	

**NOTE:**

1. Example: X address: 01 in the PLC corresponds to 0.1 in the EV5000; X address: 1F in the PLC corresponds to 1.F in the EV5000.Y\R register address, and so on.
2. EV registers in the range of addresses on the touch screen can be set to 32767, but only supports the 9999 agreement.

**Panasonic FP\_Extend**

Device	Bit Address	Word Address	Format	Notes
Output Relay	X0.0~9999.F	-----	DDDDD.H	
Input Relay	Y0.0~9999.F	-----	DDDDD.H	
Timer	T0~9999	-----	DDDD	
Counter	C0~9999	-----	DDDD	
Link Relay	L_Bit 0.0~9999.F	-----	DDDDD.H	
Link Relay	L 0~9999F	-----	DDDDD.H	
Internal Auxiliary/Relay	R0.0~9999.F	-----	DDD.H	
T/C Elapsed Value	-----	EV0~65535	DDDDD	
T/C Setting Value	-----	SV0~9999	DDDD	
Data Register	-----	DT0~262143	DDDDD	
Input Word	-----	WX0~9999	DDDD	
Output Word	-----	WY0~9999	DDDD	
Internal Auxiliary/Relay	-----	WR0~9999	DDDDD	
Link Data Register	-----	LD0~99999	DDDDD	
Link Relay	-----	WL0~9999	DDDDD	
File Register	-----	FL0~99999	DDDDD	

**Panasonic FP(Ethernet)**

Device	Bit Address	Word Address	Format
Output Relay	X0.0-10000.0	-----	DDDDD.H
Input Relay	Y0.0-10000.0	-----	DDDDD.H
Internal Auxiliary/Relay	R0.0-10000.0	-----	DDDDD.H
Link Relay	L0.0-10000.0	-----	DDDDD.H
Timer	T0-160000	-----	DDDDDD

Counter	C0-160000	-----	DDDDDD
Input Word	-----	WX0-9999	DDDD
Output Word	-----	WY0-9999	DDDD
Internal Auxiliary/Relay	-----	WR0-9999	DDDD
Link Relay	-----	WL0-9999	DDDD
File Register	-----	FL0-99999	DDDDD
Link Data Register	-----	LD0-8447	DDDD
Data Register	-----	DT0-99999	DDDDD
T/C Setting Value	-----	SV0-9999	DDDD
T/C Elapsed Value	-----	EV0-65535	DDDDD

### FP7 Series

Device	Bit Address	Word Address	Format
Input Relay	X 0.0-32767.f	-----	DDDDD.H
Output Relay	Y0.0-32767.f	-----	DDDDD.H
Internal Auxiliary/Relay	R0.0-32767.f	-----	DDDDD.H
Link Relay	L0.0-32767.f	-----	DDDDD.H
Timer	T0-4095	-----	DDDD
Counter	C0-1023	-----	DDDD
Input word	-----	WX0-511	DDD
Output word	-----	WY0-511	DDD
Internal Auxiliary/Relay	-----	WR0-32767	DDDDD
Link Relay	-----	WL0-32767	DDDDD
File register	-----	FL0-99999	DDDDD
Link Data register	-----	LD0-99999	DDDDD
Data register	-----	DT0-9829	DDDD
T Setting Value	-----	TS0-4095	DDDD
T Elapsed Value	-----	TE0-4095	DDDD
C Setting Value	-----	CS0-1023	DDDD
C Elapsed Value	-----	CE0-1023	DDDD

#### NOTE:

Example: X address:01 in the PLC corresponds to 0.1 in the HMI;X address;1F in the PLC corresponds to 1.F in the HMI.R\Y\L register address,and so on.

### FP7 Ethernet(TCP Slave)

Device	Bit Address	Word Address	Format
Input Relay	X 0.0-511.f	-----	DDD.H
Output Relay	Y0.0-511.f	-----	DDD.H
Internal Auxiliary/Relay	R0.0-2047.f	-----	DDDD.H

Link Relay	L0.0-1023.f	-----	DDDD.H
Timer	T0-4095	-----	DDDD
Counter	C0-1023	-----	DDDD
Error alarm relay	E0-4095	-----	DDDD
Input word	-----	WX0-511	DDD
Output word	-----	WY0-511	DDD
Internal Auxiliary/Relay	-----	WR0-2047	DDDD
Link Relay	-----	WL0-1023	DDDD
File register	-----	FL0-99999	DDDDD
Link Data register	-----	LD0-16383	DDDDD
Data register	-----	DT0-999423	DDDDDD
T Setting Value	-----	TS0-4095	DDDD
T Elapsed Value	-----	TE0-4095	DDDD
C Setting Value	-----	CS0-1023	DDDD
C Elapsed Value	-----	CE0-1023	DDDD

**NOTE:**

Example: X address:01 in the PLC corresponds to 0.1 in the HMI;X address;1F in the PLC corresponds to 1.F in the HMI.R\Y\L register address,and so on.

**© Cable Diagram**

**RS232 communication**

**Tool port:**

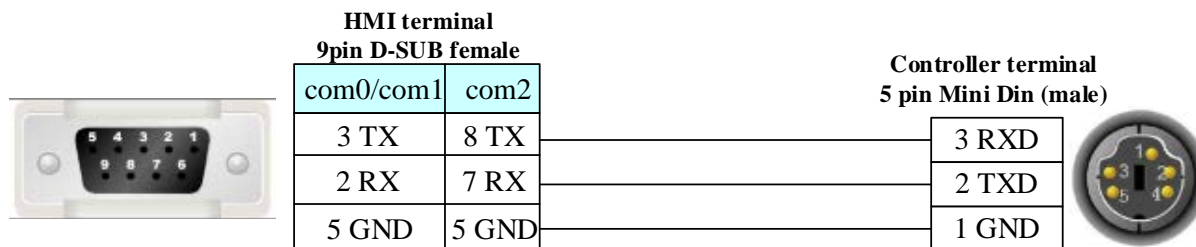

**CPU port:**

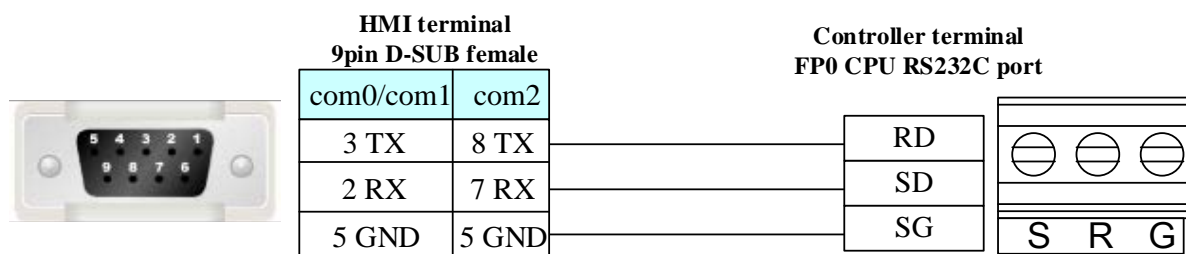

**COM port:**

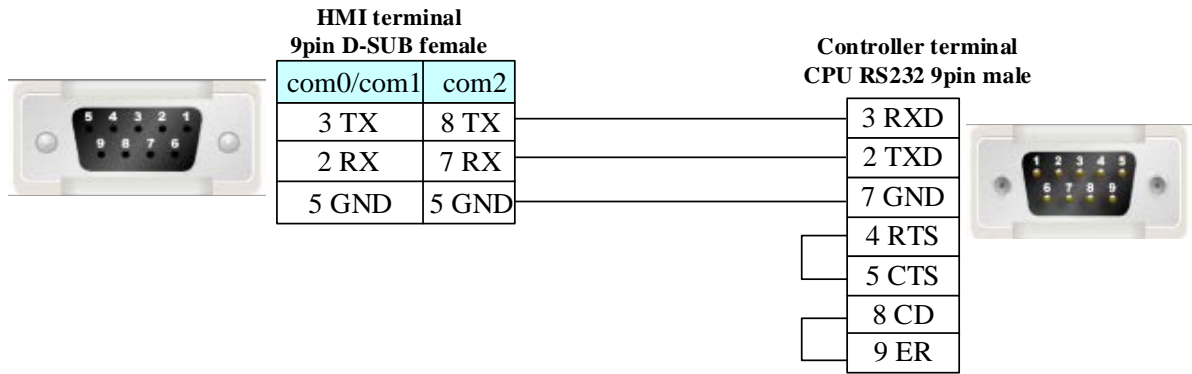

Communication module:

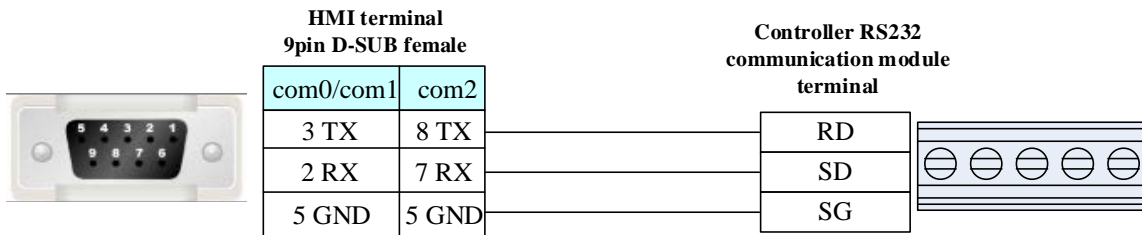

**RS485 communication**

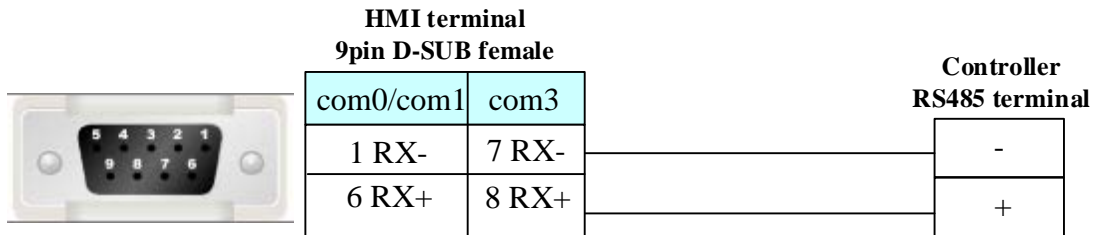

**RS422 communication**

FP3 RS422 programming port:

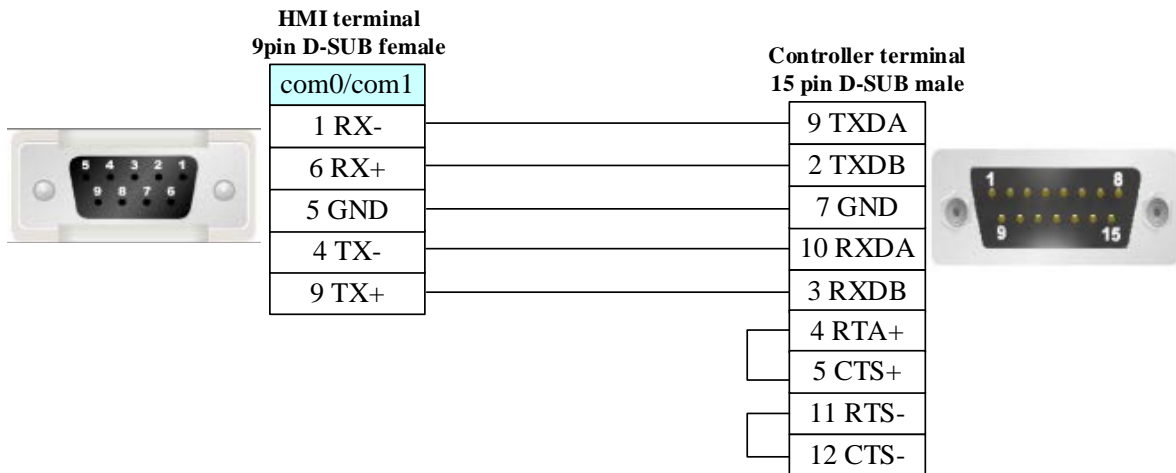

Another module RS422 communication:

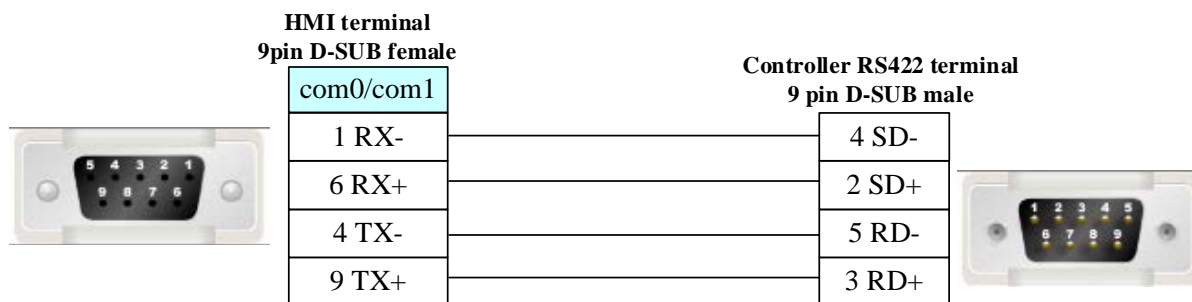

### Ethernet communication protocol cable

Cross-connection or crossover network cable can be used as communication cable via the hub

Refer to [3.3 Download by Network Ethernet](#) for method of making connection cable.

## 4.63 Parker Automation (Servo Controller)

### Serial Communication

Series	CPU	Link Module	Driver
Parker Compax3	Compax3	RS232 on CPU unit	Parker Compax3
		RS485 on CPU unit	
Parker SLVD Series	SLVD 15NS	RS485 on the CPU unit	Parker SLVD Series
Parker 6k	6K4	RS232 on the CPU unit	Parker 6k
ACR9040	ACR9040-P3-B	RS232 on the CPU unit	Parker ACR9000

### Ethernet Communication

Series	CPU	Link Module	Driver
ACR9040	ACR9040-P3-B	Ethernet interface on CPU	Parker ACR9000 Series Ethernet (TCP Slave)

### System configuration

Series	CPU	Link Module	COMM Type	Parameter	Cable
Parker Compax3	Compax3	RS232 on CPU unit	RS232	<a href="#">Setting</a>	<a href="#">Your owner cable</a>
		RS485 on CPU unit	RS485	<a href="#">Setting</a>	<a href="#">Your owner cable</a>
		RS422 on CPU unit	RS422	<a href="#">Setting</a>	<a href="#">Your owner cable</a>
Parker SLVD Series	SLVD Series	RS485 on the CPU unit	RS485	<a href="#">Setting</a>	<a href="#">Your owner cable</a>
Parker 6k	6K4	RS232 on the CPU unit	RS232	<a href="#">Setting</a>	<a href="#">Your owner cable</a>
ACR9040	ACR9040-P3-B	RS232 on the CPU unit	RS232	<a href="#">Setting</a>	<a href="#">Your owner cable</a>

### Ethernet System configuration

Series	CPU	Link Module	Connect Type	Parameter	Cable
--------	-----	-------------	--------------	-----------	-------



ACR9040	ACR9040-P3-B	Ethernet interface on CPU	Ethernet	<a href="#">Setting</a>	<a href="#">Your owner cable</a>
---------	--------------	---------------------------	----------	-------------------------	----------------------------------

### ◎ Communication Setting

#### Parker Compax3 protocol

#### HMI Setting

Default communication parameters: 115200, 8, none, 1; station: 1

#### RS232 Communication

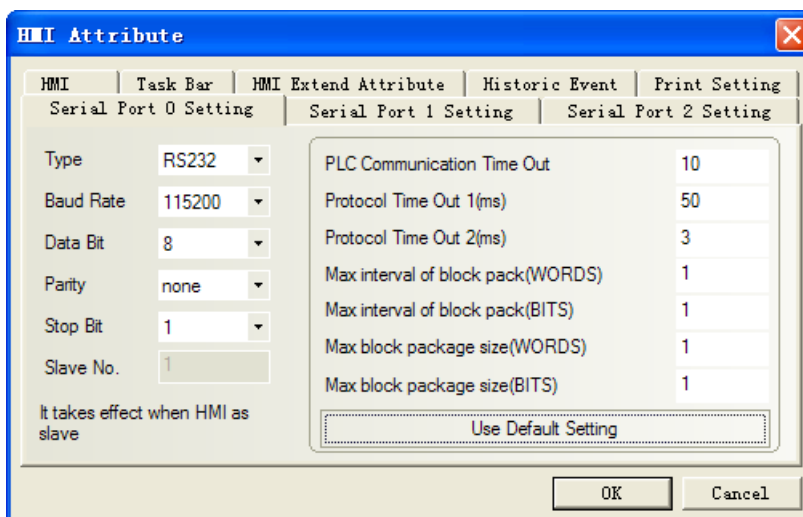

#### RS485 Communication

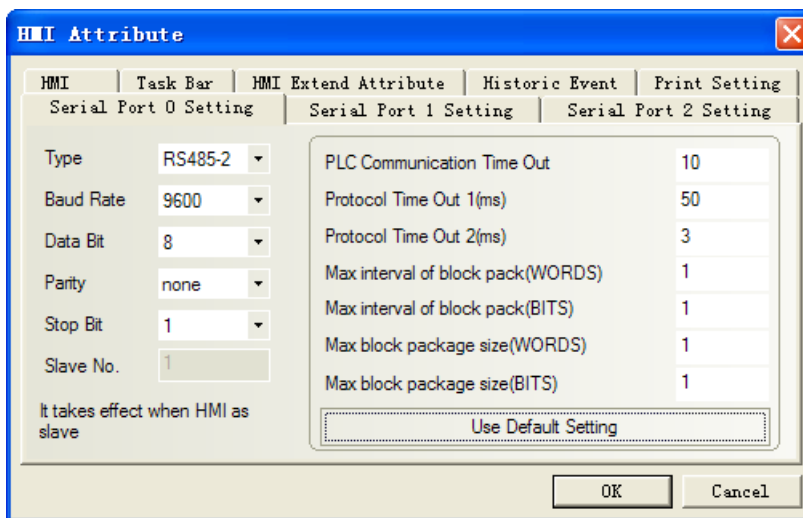

#### PLC Setting

**NOTE:** RS-485 Settings can be made in the C3 Servo Manager under "RS485 settings"

RS485 setting:

RS-485 Settings	
Master	General
Multicast Address	98
Device Address	1
Baud rate	9600
Connection Type	Two wire
Parity	No
Stop bits	1
Data bits	8

RS422 setting:

RS-485 Settings	
Master	General
Multicast Address	98
Device Address	1
Baud rate	9600
Connection Type	Four wire
Parity	No
Stop bits	1
Data bits	8

### Parker SLVD Series protocol

Default communication parameters: 9600, 8, 1, even; station: 0

[RS422 communication](#)

The screenshot shows the 'HMI Attribute' dialog box with the following settings:

Parameter	Value
Type	RS485-4
Baud Rate	9600
Data Bit	8
Parity Check	even
Stop Bit	1
Broadcast	<input type="checkbox"/> 65535
PLC Communication Time Out	3
Protocol Time Out 1(ms)	5
Protocol Time Out 2(ms)	3
Max interval of word block pack	1
Max interval of bit block pack	2
Max word block package size	1
Max bit block package size	8

Buttons: OK, Cancel, Use Default Setting

### Parker 6K protocol

Default communication parameters: 9600, 8, 1, none; station: 0

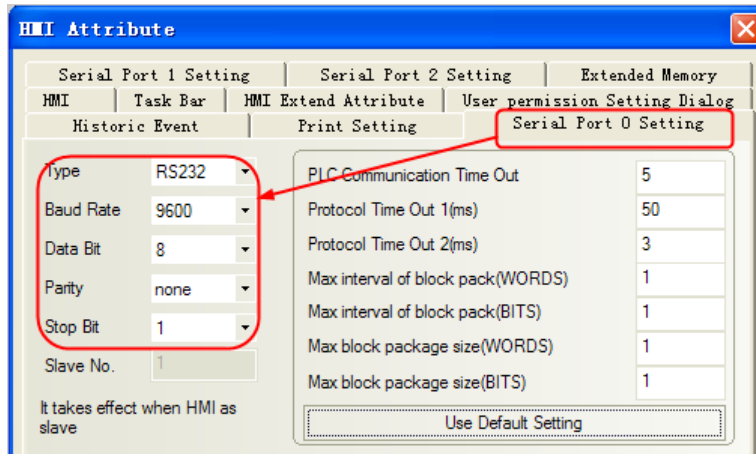

**NOTE:** Don't support RS485 communication mode

### Parker ACR9000 protocol

Default communication parameters: 38400bps, 8, none, 1; station NO.: 0

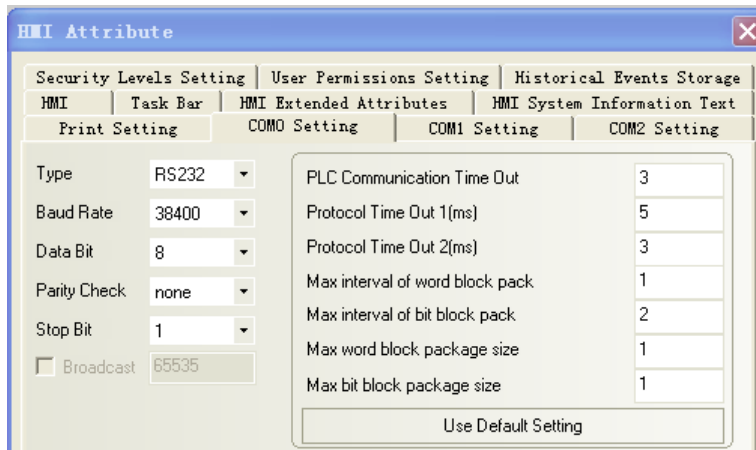

### Parker ACR9000 Series Ethernet (TCP Slave)

#### HMI Setting

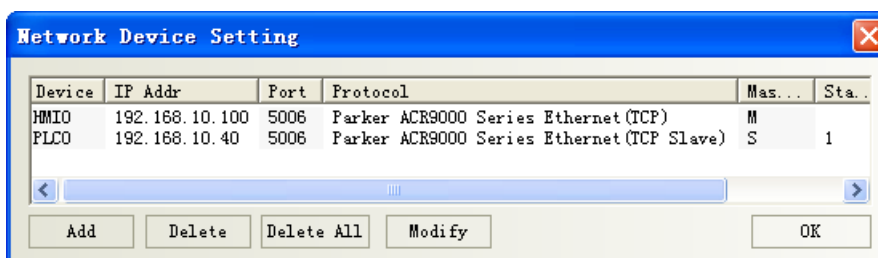
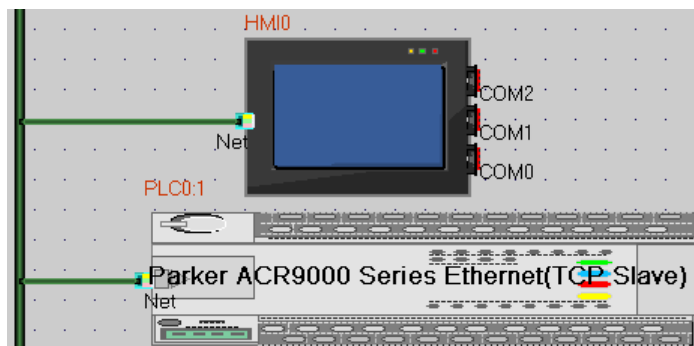

## ◎ Supported Device

### Parker Compax3

Device	Bit Address	Word Address	Format
	R_Bit 0.0-9999999.31	-----	DDDDDDD.DD
	-----	R_Float 0.0-9999.511	DDDD.DDD
	-----	R_Int 0.0-9999.511	DDDD.DDD

**NOTE:** R\_Bit device is the bit format of R\_Int device. The address of R\_Bit device is DDDDDDD.DD, the first seven position indicate the address of R\_Int, the last two position indicate 32-bit

### SLVD Series

Device	Bit Address	Word Address	Format	Note
Pr_Bit	0-9999.15	-----	DDDD.DD	
Pr_Byte	-----	0-9999	DDDD	
Pr_Word	-----	0-9999	DDDD	
Pr_DWord	-----	0-9999	DDDD	

### 6k Series

Device	Bit Address	Word Address	Format	Notes
Bit in register	VARB_bit 1.00~125.31	-----	DDD	Read only
	KILL 0	-----		
	S 0	-----		
	C 0	-----		
	PS 0	-----		
	HALT 0	-----		
	RUN 0	-----		
	TAS_Bit 1.01-2.32	-----		
	TSS_Bit 1-32	-----		
	TIN_Bit 1.01-3.32	-----		
	TOUT_Bit 1.01-3.32	-----		
The 32-bit hexadecimal value in register	-----	VARB 1~125	DDD	Read only
The integer number value in register	-----	VAR_Int 1~225	DDDD	
The real number value in register	-----	VAR_Float 1~225	DDD	
	-----	VAR 1~255	DDD	
	-----	VARS 1~255	DDD	
	-----	A 1~255	DDD	
	-----	AD 1~255	DDD	
	-----	V 1~255	DDD	

	-----	DRIVE 1~255	DDD	
	-----	TAS 1~2	D	
	-----	TPC 1~255	DDD	
	-----	TPE 1~255	DDD	
	-----	TER 0	D	
	-----	TSS 0	D	
	-----	TIN 1~3	D	
	-----	TOUT 1~3	D	

**NOTE:** VARB configuration software need to use hexadecimal data type, integer-bit to 8 bits.

**ACR9000、Parker ACR9000 Series Ethernet (TCP Slave)**

Device	Bit Address	Word Address	Format	Notes
P_low16bit	0.0~99999.f	-----	DDDDD.FF	
P_high16bit	0.0~99999.f	-----	DDDDD.FF	
P_int32	-----	0~99999	DDDDD	
P_float	-----	0~99999	DDDDD	

**© Cable Diagram**

**Parker Compax3 Series**

**RS232 Communication Cable**

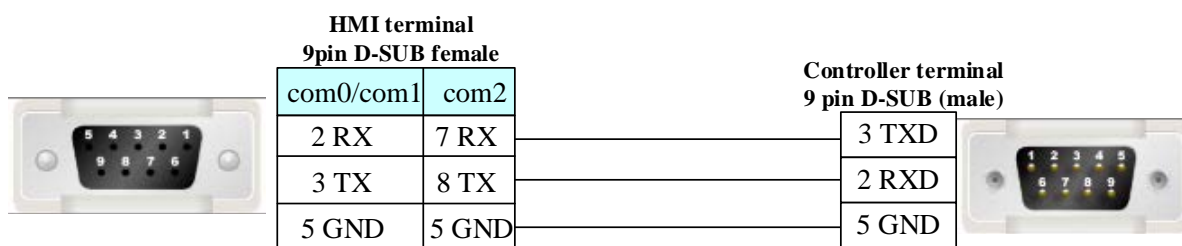

**RS485 Communication Cable**

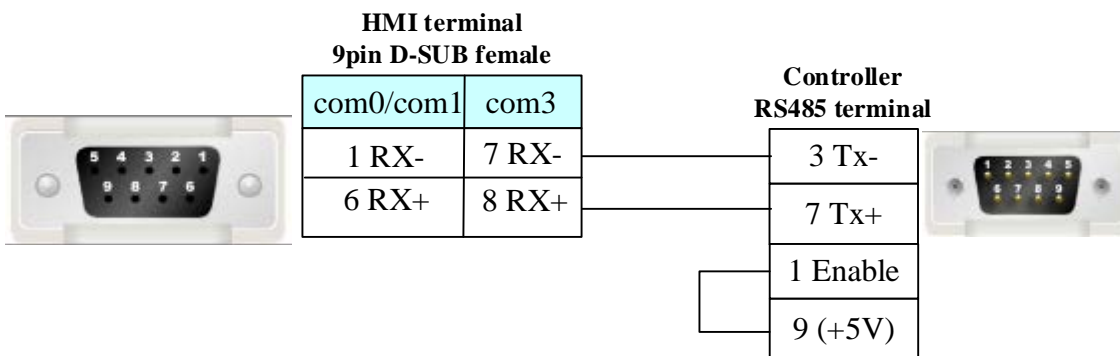

**RS422 Communication Cable**

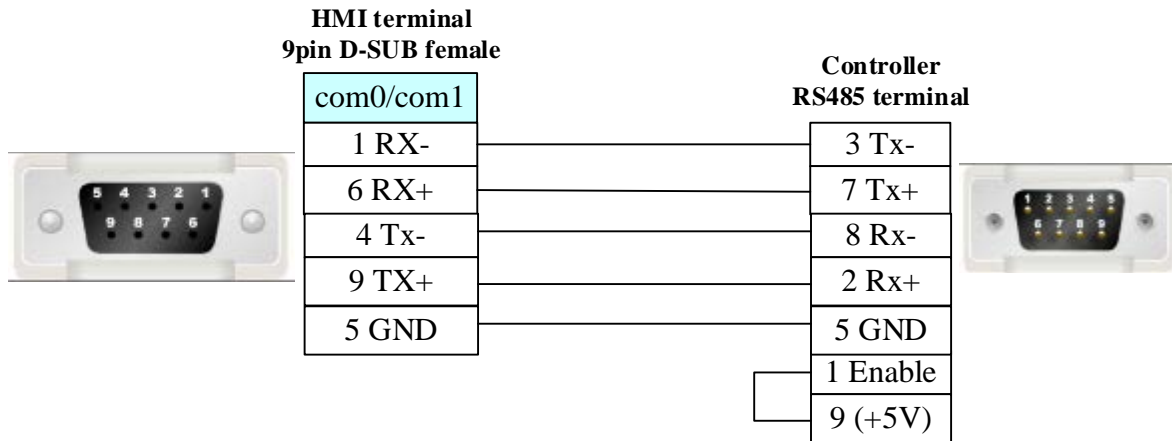

**SLVD Series**

**RS485 Communication Cable**

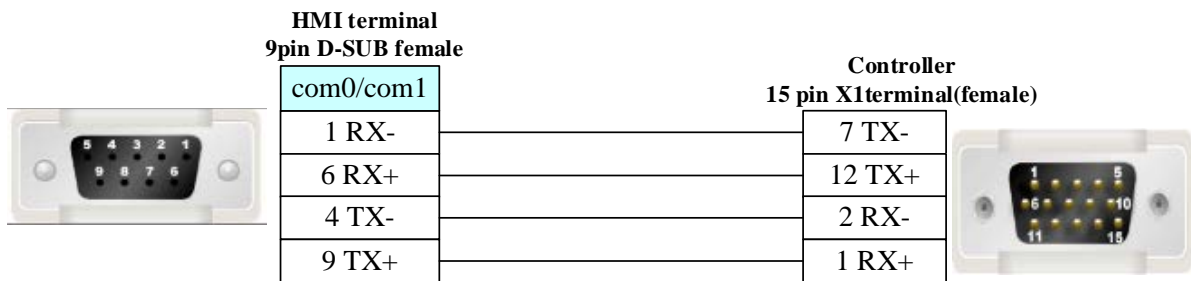

**6k/9000 Series**

**RS232 Communication Cable**

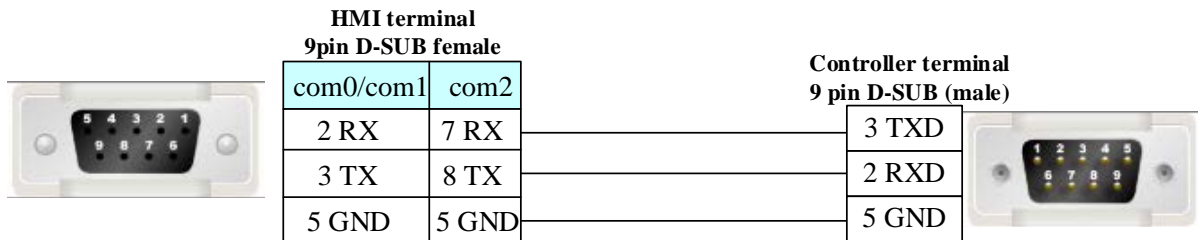

**Ethernet communication protocol cable**

Cross-connection or crossover network cable can be used as communication cable via the hub

Refer to [3.3 Download by Network Ethernet](#) for method of making connection cable.

**4.64 PMAC Motion Controller**

© **Serial Communication**

Series	CPU	Link Module	Driver
PC/104	PC/104	RS232 on the CPU unit	PMAC series

## ◎ System configuration

Series	CPU	Link Module	COMM Type	Parameter	Cable
PC/104	PC/104	RS232 on the CPU unit	RS232	<a href="#">Setting</a>	<a href="#">Your owner cable</a>

## ◎ Communication Setting

### HMI Setting

Default communication parameters: 38400bps, 8, none, 1; station: 0

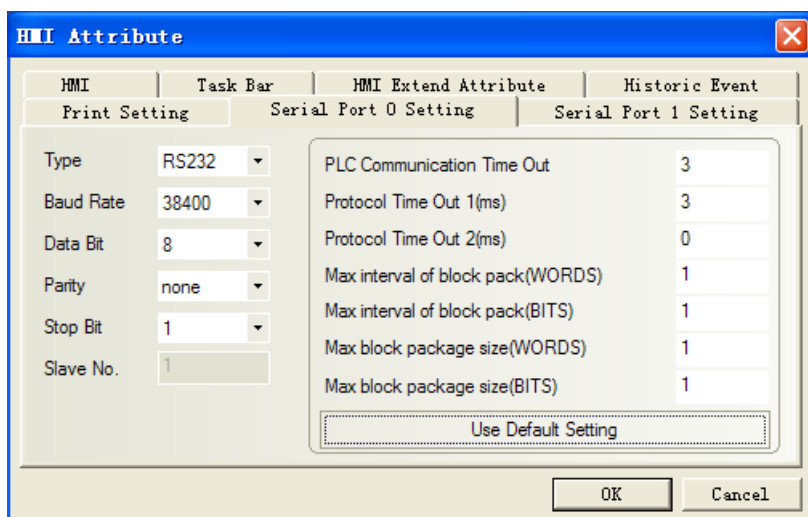

## ◎ Supported Device

Device	Bit Address	Word Address	Format	Notes
I variable	-----	I 0-9999	DDDD	R/W
M variable	-----	M 0-9999	DDDD	R/W
P variable	-----	P 0-9999	DDDD	R/W
Q variable	-----	Q 0-9999	DDDD	R/W
I variable Float	-----	I_float 0-9999	DDDD	R/W
P variable Float	-----	P_float 0-9999	DDDD	R/W
Q variable Float	-----	Q_float 0-9999	DDDD	R/W
report position of motor	-----	POS 0	D	R
report velocity of motor	-----	VEL 0	D	R
report following error of motor	-----	FER 0	D	R
common manual and programming command	-----	ORD/JOG* 0-9999	DDDD	W
Run current program	-----	RUN 0-9999	DDDD	W
Halt program	-----	HLT 0-9999	DDDD	W

**NOTE:** Some addresses in I variable devices are on with hex number, when single float number on, all bits which can't be transformed into hex numbers will be "0"

### PMAC common manual commands

(0) ORD/JOG 0000: j+:: continual positive rotation command

- (1) ORD/JOG 0010: j- : continual reverse rotation command
- (2) ORD/JOG 0020: j/ : stop command
- (3) ORD/JOG 0030: j=constant
- (4) ORD/JOG 0040: j: constant
- (5) ORD/JOG 0050: j ^
- (6) ORD/JOG 0060: # n
- (7) ORD/JOG 0070: home (hm) : manual reset zero commands
- (8) ORD/JOG 0080: homez (hmz) : manual reset zero position commands

### PMAC common programming commands

- (0) ORD/JOG 0100: & n
- (1) ORD/JOG 0110: B m R
- (2) ORD/JOG 0120: B m S
- (3) ORD/JOG 0130: A (ctrl A) : Stop movement program
- (4) ORD/JOG 0140: K (ctrl K) : Stop movement program and close enable signal
- (5) ORD/JOG 0150: Enable PLC n: Enable PLC, n indicates prog no. of PLC, range 0-31
- (6) ORD/JOG 0160: Disable PLC n: Disable PLC, n indicates prog no. of PLC, range 0-31

### © Cable Diagram

#### RS232 Communication Cable

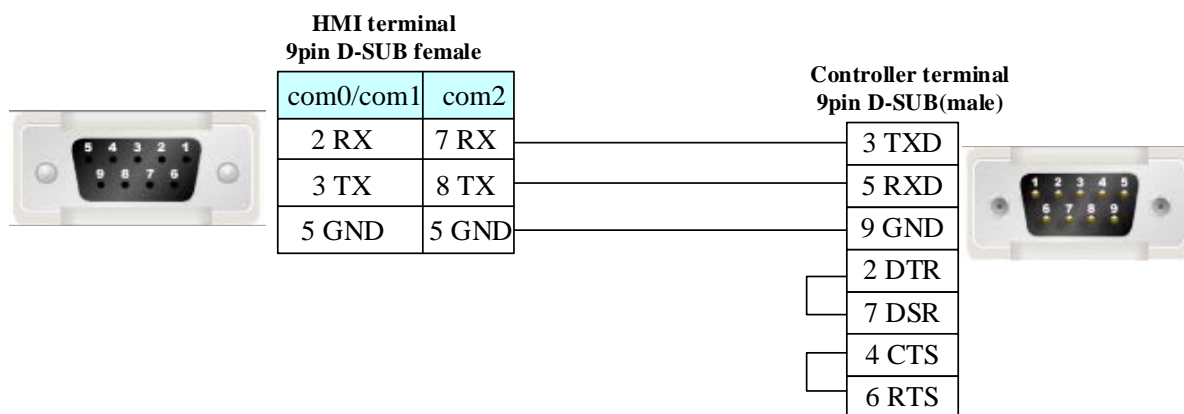

## 4.65 Power-one AURORA Wind Inverter

### © Serial Communication

Series	CPU	Link Module	Driver
AURORA	PVI-6000-OUTD-US-W	RS485 on the port	Aurora PV

### © System configuration

Series	CPU	Link Module	COMM Type	Parameter	Cable
AURORA	PVI-6000-OUTD-US-W	RS485 on the port	RS485	<a href="#">Setting</a>	<a href="#">Your owner cable</a>



## ◎ Communication Setting

### HMI Setting

Default communication parameters: 19200, 8, none, 1; station: 2

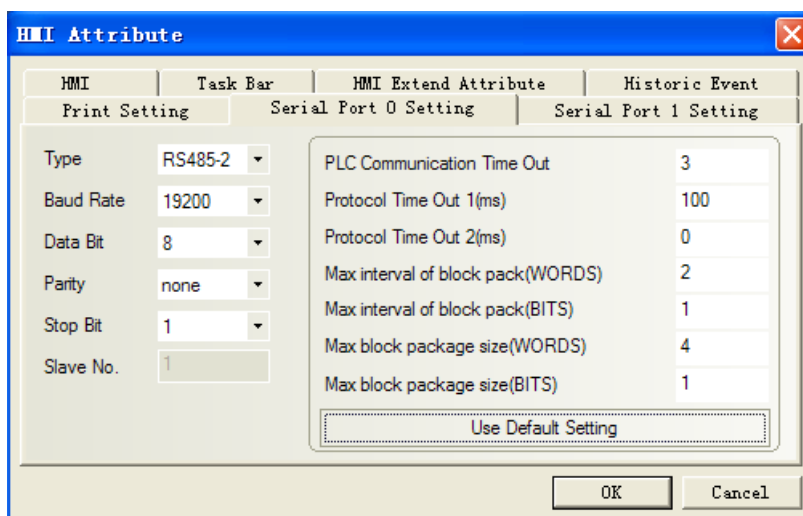

## ◎ Supported Device

Device	Bit Address	Word Address	Format
Time Register ( double word )	-----	Time 0-9999.7	DDDDD.0
Energy Register ( double word )	-----	Energy 0-9999.7	DDDDD.0
Status variable Register ( double word )	-----	Measure 0-9999.7	DDDDD.0
Hardware version ( double word )	-----	Fireware 0-9999.7	DDDDD.0
Software version ( double word )	-----	Version 0-9999	DDDD
Device sequence No. ( double word )	-----	SN 0-9999	DDDD
Device ID ( double word )	-----	PN 0-9999	DDDD
Device work status	-----	State 0-9999	DDDD

## ◎ Cable Diagram

**NOTE:** AURORA Wind Inverter supports two connection modes, please refer to the manual of power-one Corporation for details.

### 1. Connect with RS485 port

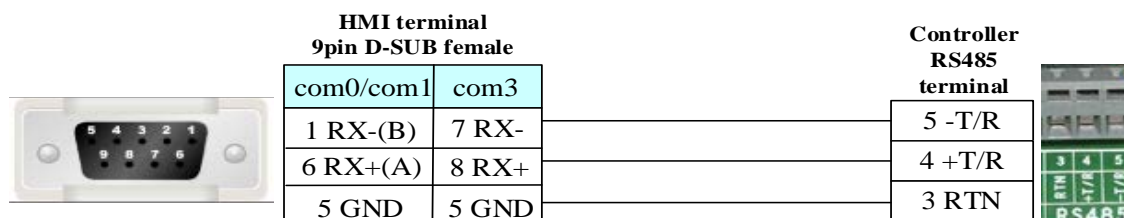

### 2. Connect with RJ12

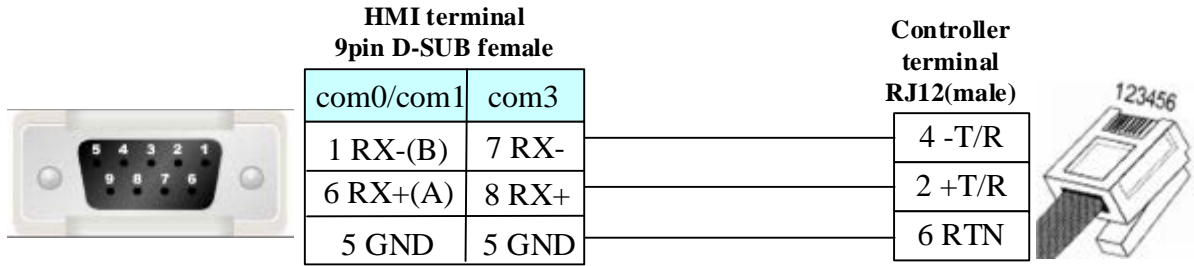

## 4.66 Profibus DP Slave

### Serial Communication

Series	CPU	Link Module	Driver
SIMATIC S7-300/400	ALL CPUs that have the DP port	PROFIBUS DP port on the External Device	Profibus DP Slave
Other company devices which support PROFIBUS DP Master		PROFIBUS DP port	

### System configuration

Series	CPU	Link Module	Parameter	SIP Type
SIMATIC S7-300/400	ALL CPUs that have the DP port	PROFIBUS DP port on the External Device	<a href="#">Setting</a>	Profibus
Other company devices which support PROFIBUS DP Master		PROFIBUS DP port	<a href="#">Setting</a>	

### Communication Setting

#### HMI Setting

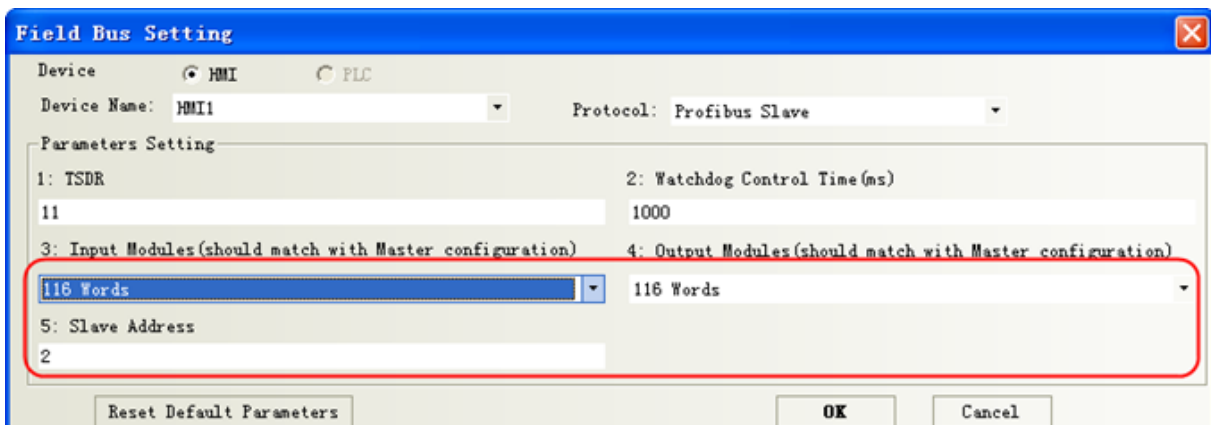
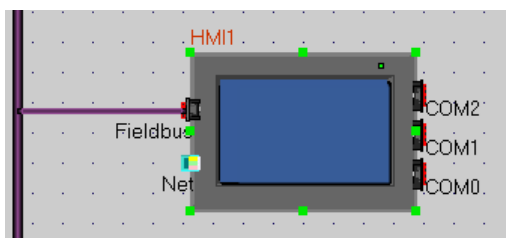

**NOTE:** Input and Output Modules should match with Master Configuration.

### PLC Setting

**NOTE:** you can find kinco.gsd in the fieldbus file of EV5000 Installation Directory, or you can download from [www.kinco.cn](http://www.kinco.cn).

#### 1. Setup kinco.gsd file

Setup GSD file in the s7-300 software.

##### Process:

- (1) . Closed all the station in HW Config
- (2) .choose “option” > “install GSD file”.
- (3) .Find out the folder of eview.gsd.
- (4) .Choose eview.gsd, and then click the install button.

You can find the ico in PROFIBUS DP\MMI, after installing

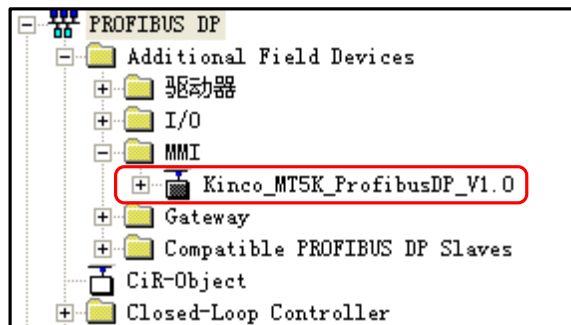

#### 2. configuration setting

- (1) Make a new project in s7-300 through the guide
- (2) We must use OB82, OB86, OB100, OB121 and OB122 in BLOCK, or system will go wrong when PLC is power-up.
- (3) Double click HW Config, choose “DP” and right click “add master station”.

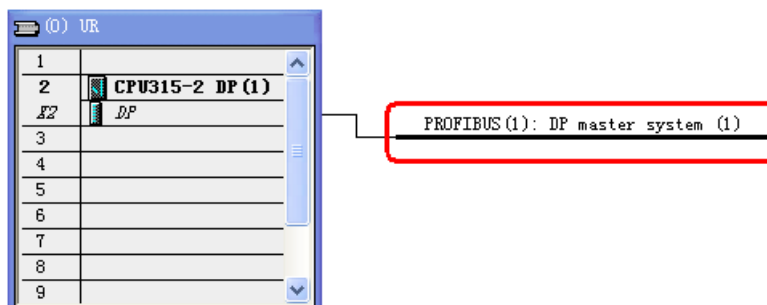
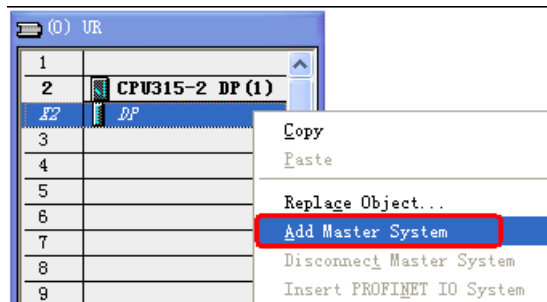

- (4) Right click, choose “Insert Object”



Click “Kinco\_MT5K\_ProfibusDP\_V1.0”, set address.

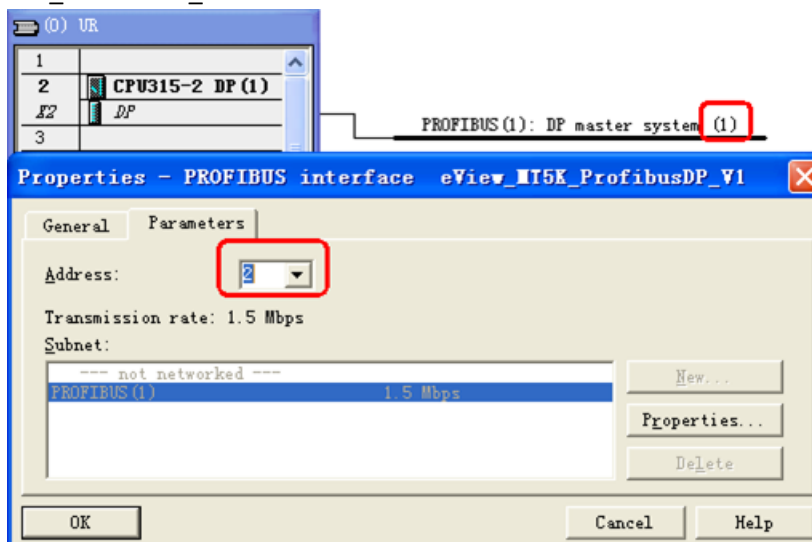

**NOTE:** the address No. of DP master station and slave can not be same.

(5) Input and output setting

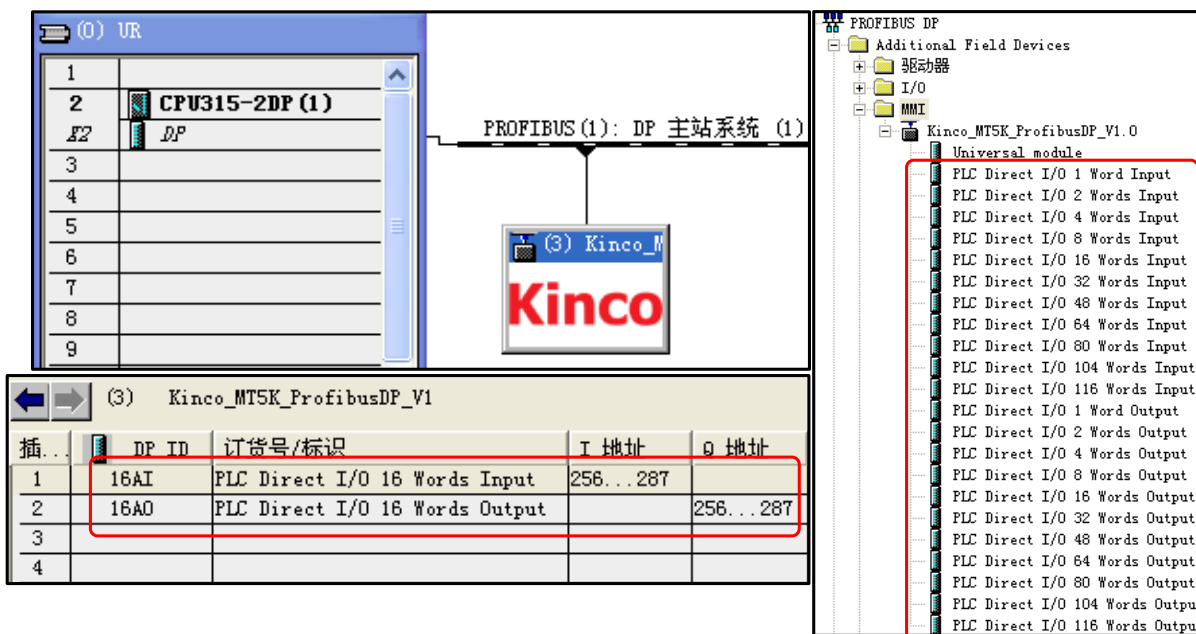

(6) Profibus DP Slave has adaption function, you can change the transmission rate of DP master station, maximum is 12Mbps.

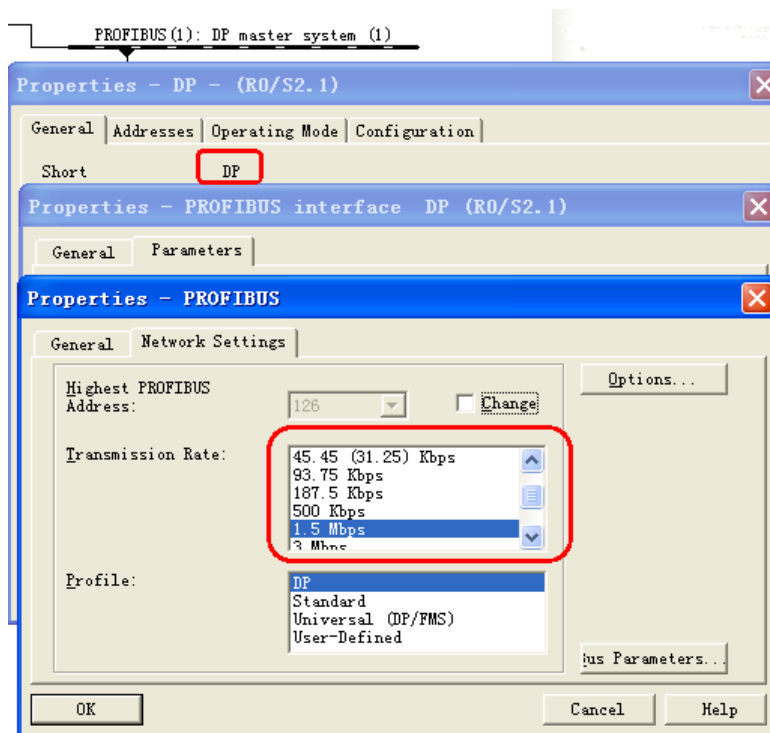

(7) Double click slave ico, then set User\_Prm\_Data (0) =01

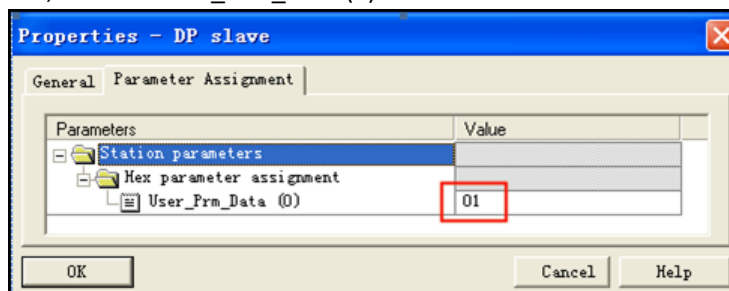

### ◎Supported Device

Device	Bit Address	Word Address	Format	Notes
Direct I/O Input	LW.B8500.0~8615.F	-----	DDDD.H	
Direct I/O Output	LW.B8000.0~8115.F	-----	DDDD.H	
Direct I/O Input	-----	LW8500~8615	DDDD	correspond PIW
Direct I/O Output	-----	LW8000~8115	DDDD	correspond PQW
Direct I/O Input	-----	LW8500~8615(Data width is dword)	DDDD	correspond PID
Direct I/O Output	-----	LW8000~8115(Data width is dword)	DDDD	correspond PQD

**NOTE:** When use either PID or PQD, you must set User\_Prm\_Data (0) =1 if HMI communication with the DP port of Siemens; Other company devices which support PROFIBUS DP Master, default User\_Prm\_Data (0) =0.

### ◎Cable Diagram

A-type violet cable

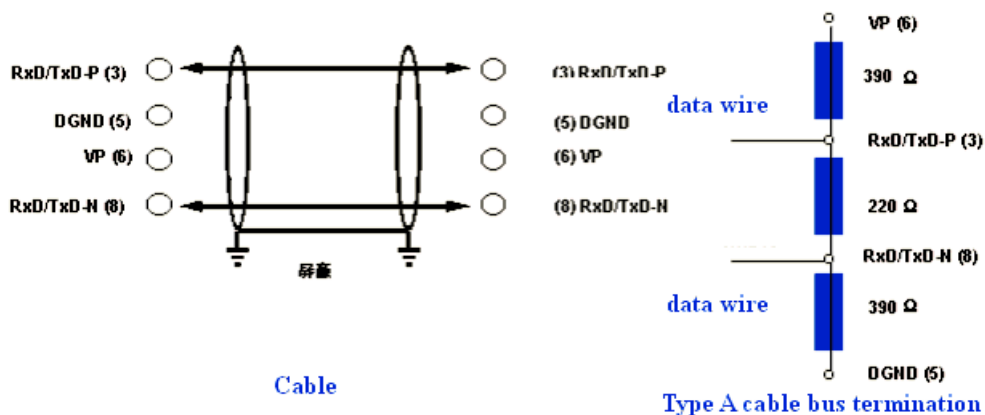

### 4.67 RF-IC (Card Reader)

#### Serial Communication

Series	CPU	Link Module	Driver
RF-IC	RF-IC	RS232 on the CPU unit	RF-IC

#### System configuration

Series	CPU	Link Module	COMM Type	Parameter	Cable
RF-IC	RF-IC	RS232 on the CPU unit	RS232	<a href="#">Setting</a>	<a href="#">Your owner cable</a>

#### Communication Setting

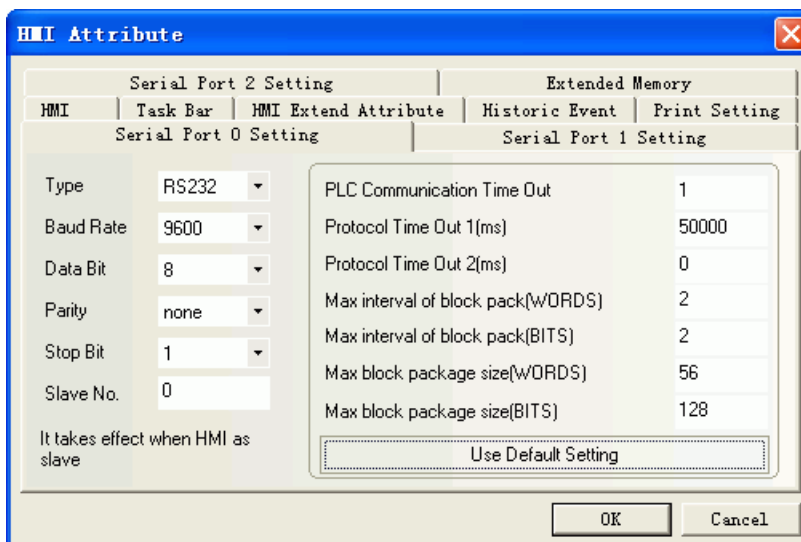

#### Supported Device

Device	Bit Address	Word Address	Format	Notes
Bit	LB 8999	-----	DDDD	
	-----	LW 8900	DDDD	

**NOTE:** LB8999 means bar code has received or not. LB8999=1 means data has received.

### ◎ Cable Diagram

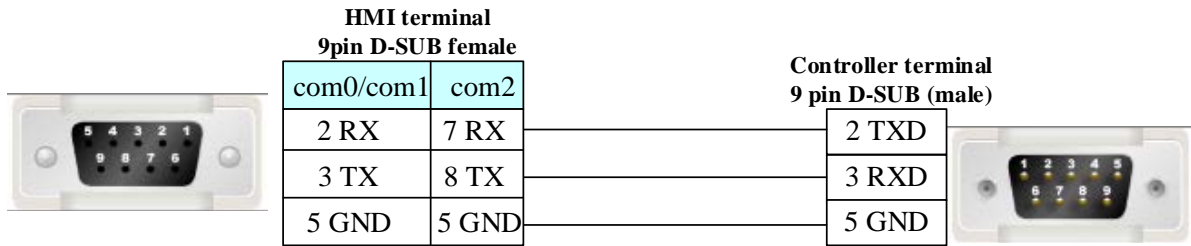

### 4.68 RKC Instrument INC.

### ◎ Serial Communication

Series	CPU	Link Module	Driver
RKC CH	CH402WK02-VV*AN-5N	CPU direct	RKC CH402

### ◎ System configuration

Series	CPU	Link Module	COMM Type	Parameter	Cable
RKC CH	CH402WK02-VV*AN-5N	RS485 the CPU unit	RS485	<a href="#">Setting</a>	<a href="#">Your owner cable</a>

### ◎ Communication Setting

#### HMI Setting

Default communication: 9600, 8, none, 1; station: 1

[RS485 communication](#)

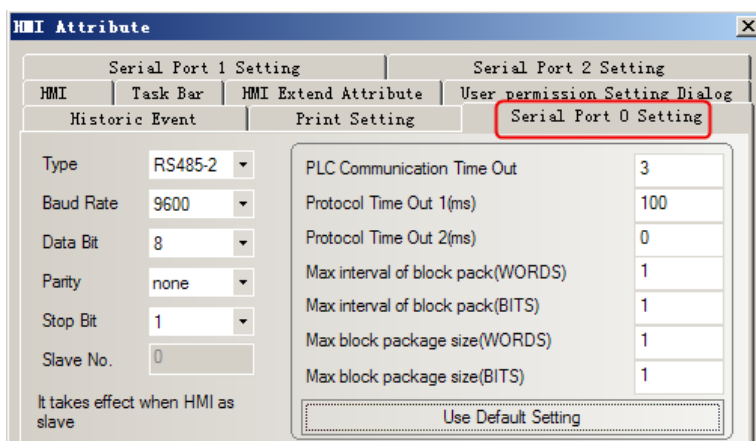

#### PLC Setting

Press "SET" key and "< R/S" key at one time, then press the SET key and select parameters:

- |     |                     |
|-----|---------------------|
| Add | Address *1          |
| bPS | Baudrate *2         |
| bit | data instruction *3 |

InT transmission delay \*4

\*1: Two bits ASCII code. Example 23, instrument number must 23(32H 33H)

\*2: Baudrate controlled by code as below; default value: 2

0: 2400 bps

1: 4800 bps

2: 9600 bps

3: 19200 bps

\*3: data instruction controlled by code as below; default value: 0

ID	Data bit	parity	stop bit
0	8	none	1
1	8	none	2
2	7	odd	1
3	7	odd	2
4	7	even	1
5	7	even	2

### © Supported Device

Device	Bit Address	Word Address	Format	Notes
Alarm 1 status	AA: 0	-----	D	Read only
Burnout	B1: 0	-----	D	Read only
PID control/Autotuning	G1: 0	-----	D	R/W
Alarm 2 status	AB: 0	-----	D	Read only
RUN/STOP transfer	SR: 0	-----	D	R/W
Self-tuning	G2:0	-----	D	R/W
Measured value	-----	M1: 0	D	Read only
Current transformer input1	-----	M2: 0	D	Read only
Current transformer input2	-----	M3: 0	D	Read only
Error code	-----	ER: 0	D	Read only
Set value(SV1)	-----	S1: 0	D	R/W
Alarm 1 setting	-----	A1: 0	D	R/W
Alarm 2 setting	-----	A2: 0	D	R/W
Heater break alarm 1 setting	-----	A3: 0	D	R/W
Heater break alarm 2 setting	-----	A4: 0	D	R/W
Control loop break alarm	-----	A5: 0	D	R/W
Heat-side proportional band	-----	P1: 0	D	R/W
Integral time	-----	I1: 0	D	R/W
Derivative time	-----	D1: 0	D	R/W
Anti-reset windup	-----	W1: 0	D	R/W
Cool-side proportional band	-----	P2: 0	D	R/W
Overlap/deadband	-----	V1: 0	D	R/W
Heat-side proportioning cycle	-----	T0: 0	D	R/W
Cool-side proportioning cycle	-----	T1: 0	D	R/W
PV bias	-----	PB: 0	D	R/W



Set data lock function	-----	LK: 0	D	R/W
------------------------	-------	-------	---	-----

### ◎ Cable Diagram

#### RS485 Communication Cable

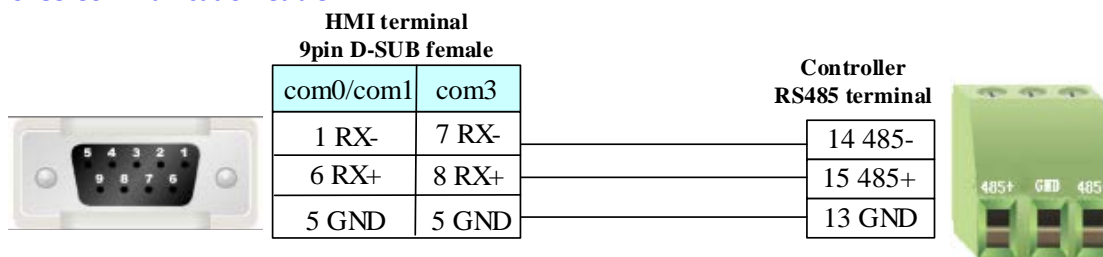

#### CAN bus Communication Cable

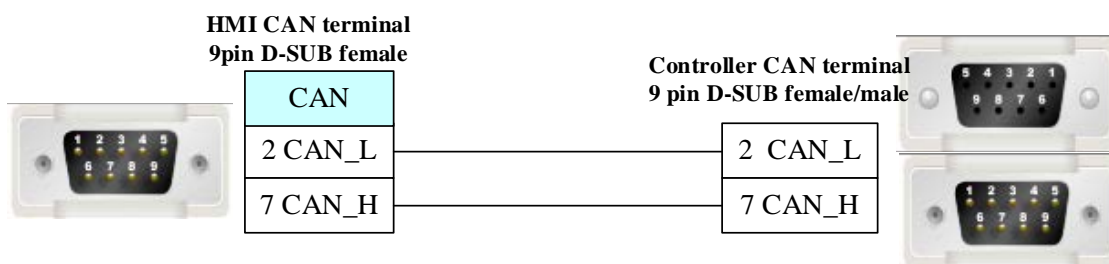

## 4.69 Saia-Burgess

### ◎ Serial Communication

Series	CPU	Link Module	Driver
PCS	PCS1.C8	RS232 on the CPU unit	Saia SBus
PCD	PCD2.M110	RS232 on the CPU unit	
	PCD2.M120		
	PCD2.M150		
	PCD2.M170		
	PCD2.M480		

### ◎ Systems Configuration

Series	CPU	Link Module	COMM Type	Parameter	Cable
PCS	PCS1.C8	RS232 on the CPU unit	RS232	<a href="#">Setting</a>	<a href="#">Your owner cable</a>
		RS485 on the CPU unit	RS422	<a href="#">Setting</a>	<a href="#">Your owner cable</a>
PCD	PCD2.M110	RS232 on the CPU unit	RS232	<a href="#">Setting</a>	<a href="#">Your owner cable</a>

### ◎ Communication Setting

#### HMI Setting

Default communication: 9600, 8, none, 1; station: 80

#### RS232 communication

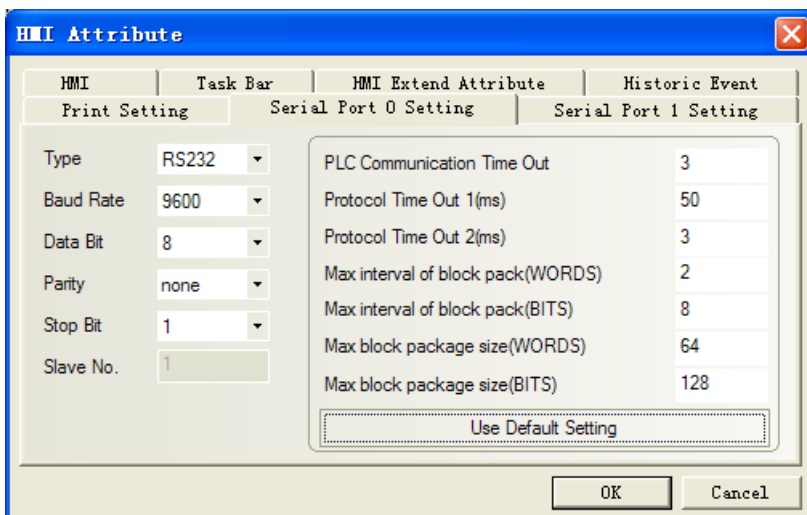

**RS485 communication**

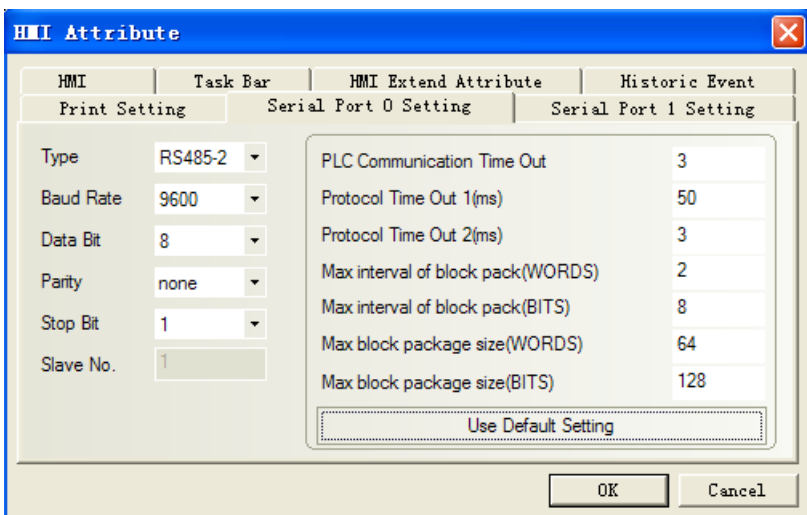

**© Supported Device**

Device	Bit Address	Word Address	Format	Notes
Input	I0-8091	-----	DDDDD	
Output	O0-8091	-----	DDDDD	
Flag	F0-8091	-----	DDDD	
Timer	-----	T0-1599	DDDD	
Counter	-----	C0-1599	DDDD	
Register	-----	R0-4095	DDDD	
Register ( support single float point )	-----	R_Float0-4095	DDDD	

**© Cable Diagram**

**PCS1.C8**

**RS232 communication cable**

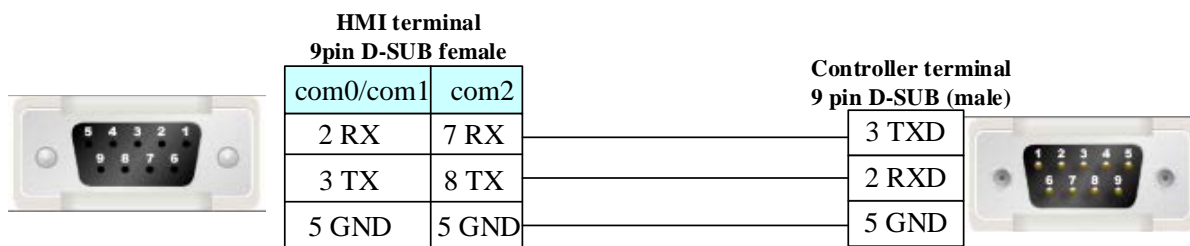

**RS485 communication cable**

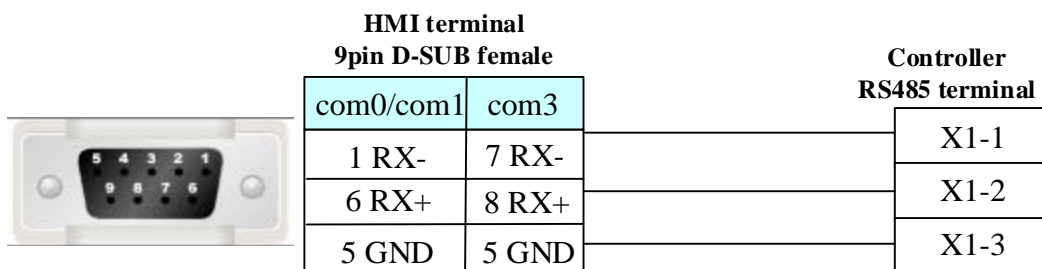

**PCD2.M110**

**RS232 communication cable**

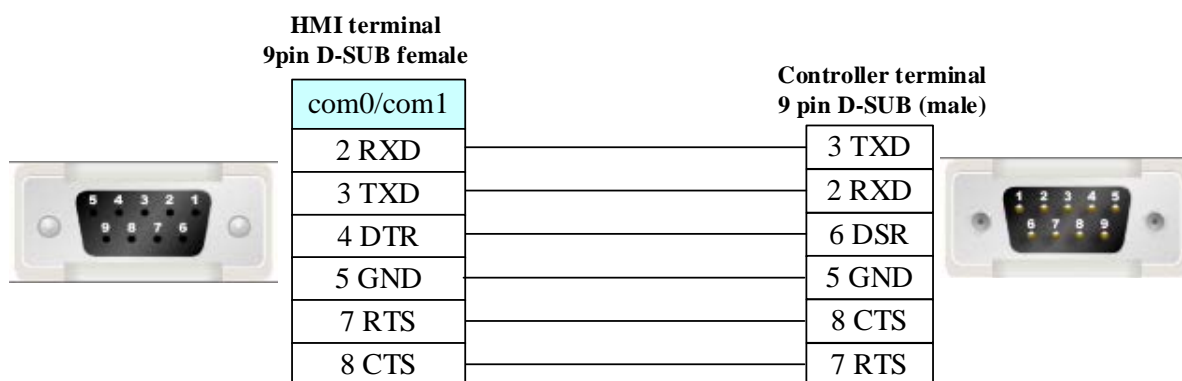

**4.70 Sailors D9 (Temperature Controller)**

© **Serial Communication**

Series	CPU	Link Module	Driver
Sailors D9	Swp-T16-80-08-N	RS232 on the CPU unit	Sailors D9

© **System configuration**

Series	CPU	Link Module	COM Type	Parameter	Cable
Sailors D9	Swp-T16-80-08-N	RS485 on the CPU unit	RS485	<a href="#">Setting</a>	<a href="#">Your owner cable</a>

## ◎ Communication Setting

### HMI Setting

Default communication parameters: 9600, 8, none, 1; station: 80

### RS485 communication

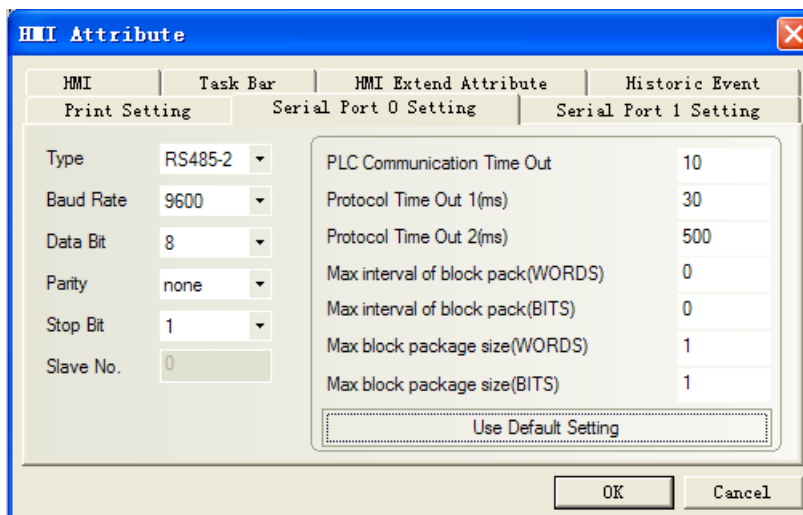

## ◎ Supported Device

Device	Bit Address	Word Address	Format	Notes
Channel Sample Value	-----	CH 0~16	DD	
Channel Indexing	-----	SN 1~16	DD	

## ◎ Cable Diagram

### RS485 communication cable

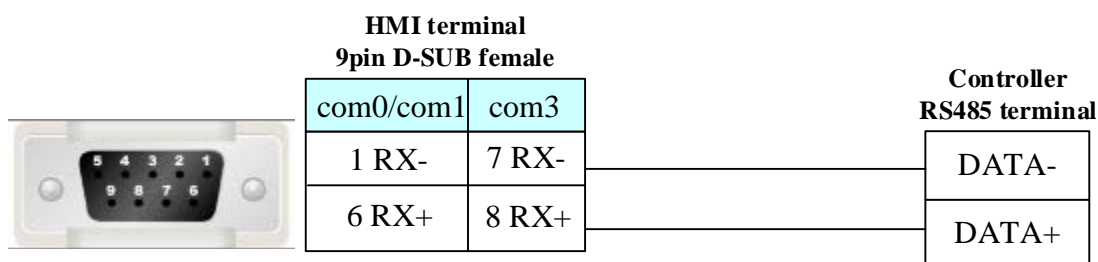

## 4.71 Schneider Electric, Ltd.

### ◎ Serial Communication

Series	CPU	Link Module	Driver
Micro	TSX3705001 TSX 37 05 028DR1 TSX 37 08 056DR1	TER port on the CPU	Schneider Modicon Uni-TelWay Modbus RTU

	TSX 37 10 128DT1 TSX 37 10 128DR1 TSX 37 10 128DTK1 TSX 37 10 164DTK1 TSX 37 10 028AR1 TSX 37 10 028DR1 TSX 37 21 101 TSX 37 22 101 TSX 37 21 001 TSX 37 22 001		
Premium	TSX P57 103M TSX P57 153M TSX P57 203M TSX P57 253M TSX P57 303M TSX P57 353M TSX P57 453M	TER port on the CPU	
Nano	TSX 07 3L □□□□28 TSX 07 30 10□□□□ TSX 07 31 16□□□□ TSX 07 31 24□□□□ TSX 07 32 □□□□28 TSX 07 33 □□□□28	Programming port on CPU	
Twido	TWD LCAA 10DRF TWD LCAA 16DRF TWD LCAA 24DRF TWD LMDA 20DTK TWD LMDA 20DUK TWD LMDA 20DRT TWD LMDA 40DTK TWD LMDA 40DUK	RS485 on the CPU unit	Schneider Twido Modbus RTU
M Series	TM258LD42DT TM258LF42DT	RS232 on the CPU unit RS485 on the CPU unit	Schneider M Series

### ◎ Network communication

Series	CPU	Link Module	Driver
M Series	TM258LD42DT TM258LF42DT	ETH on the CPU unit	Schneider Ethernet(TCP Slave)

### ◎ Serial System configuration

Series	CPU	Link Module	Driver	COMM Type	Parameter	Cable
Modicon TSX	TSX3705001 TSX3705001	RS485 on the CPU unit	Schneider Modicon	RS232 RS485	<a href="#">Setting</a> <a href="#">Setting</a>	<a href="#">Your owner cable</a> <a href="#">Your owner cable</a>

	TSX 37 05 028DR1 TSX 37 08 056DR1 TSX 37 10 128DT1 TSX 37 10 128DR1 TSX 37 10 128DTK1 TSX 37 10 164DTK1 TSX 37 10 028AR1 TSX 37 10 028DR1 TSX 37 21 101 TSX 37 22 101 TSX 37 21 001 TSX 37 22 001		Uni-TelWay			
	TSX3705001 TSX3705001 TSX 37 05 028DR1 TSX 37 08 056DR1 TSX 37 10 128DT1 TSX 37 10 128DR1 TSX 37 10 128DTK1 TSX 37 10 164DTK1 TSX 37 10 028AR1 TSX 37 10 028DR1 TSX 37 21 101 TSX 37 22 101 TSX 37 21 001 TSX 37 22 001	RS485 on the CPU unit	Modbus RTU	RS232	<a href="#">Setting</a>	<a href="#">Your owner cable</a>
				RS485	<a href="#">Setting</a>	<a href="#">Your owner cable</a>
Twido	TWD LCAA 10DRF TWD LCAA 16DRF TWD LCAA 24DRF TWD LMDA 20DTK TWD LMDA 20DUK TWD LMDA 20DRT TWD LMDA 40DTK TWD LMDA 40DUK	RS485 on the CPU unit		RS232	<a href="#">Setting</a>	<a href="#">Your owner cable</a>
				RS485	<a href="#">Setting</a>	<a href="#">Your owner cable</a>
M Series	TM258LD42DT TM258LF42DT	RS232 on the CPU unit		RS232	<a href="#">Setting</a>	<a href="#">Your owner cable</a>
		RS485 on the CPU unit		RS485	<a href="#">Setting</a>	<a href="#">Your owner cable</a>

### ◎ Network System configuration

Series	CPU	Link Module	COMM Type	Parameter	Cable
M Series	TM258LD42DT TM258LF42DT	ETH on the CPU unit	Ethernet	<a href="#">HMI Setting</a>	<a href="#">Your owner cable</a>

### ◎ Serial Communication Setting

## HMI Setting

### Schneider Modicon Uni-TelWay protocol

Default communication: 9600, 8, odd, 1; station:1

#### RS232 communication

**NOTE:** Cable by Schneider Electric Industries, Rotary switch setting: 2(TER Direct)

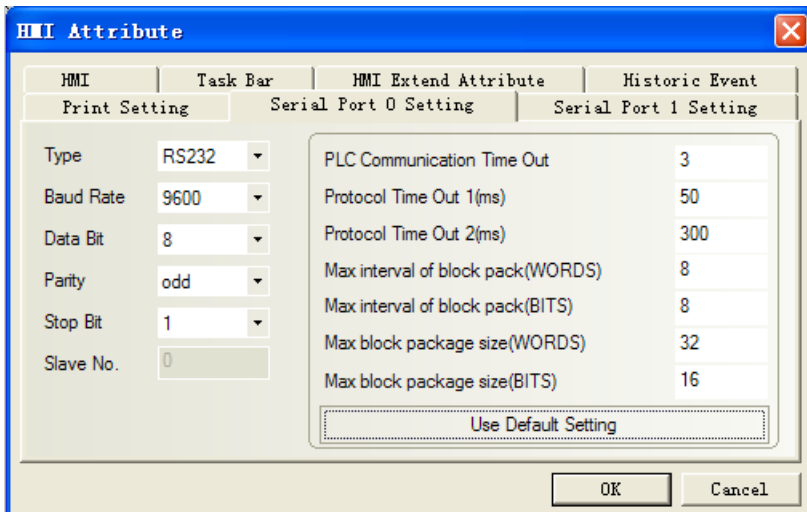

#### RS485 communication

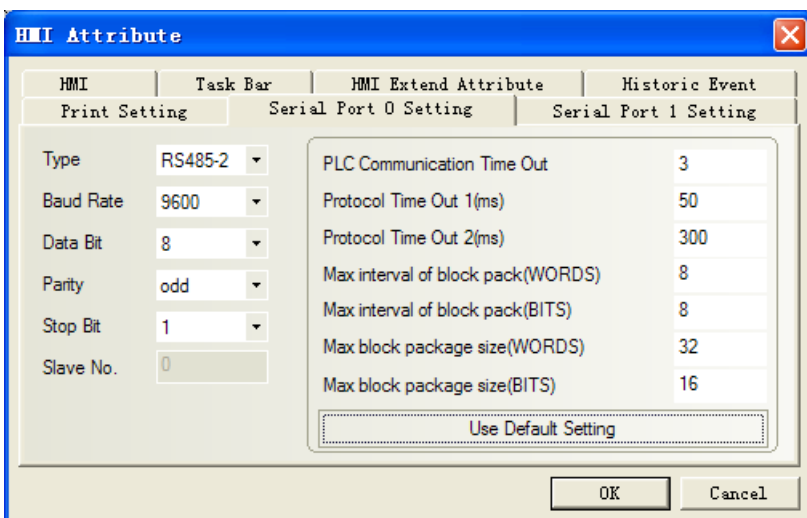

### Modbus RTU protocol

Default communication: 9600, 8, even, 1; station: 1

#### RS232 communication

**NOTE:** Cable by Schneider Electric Industries, Rotary switch setting: 3(OTHER Direct)

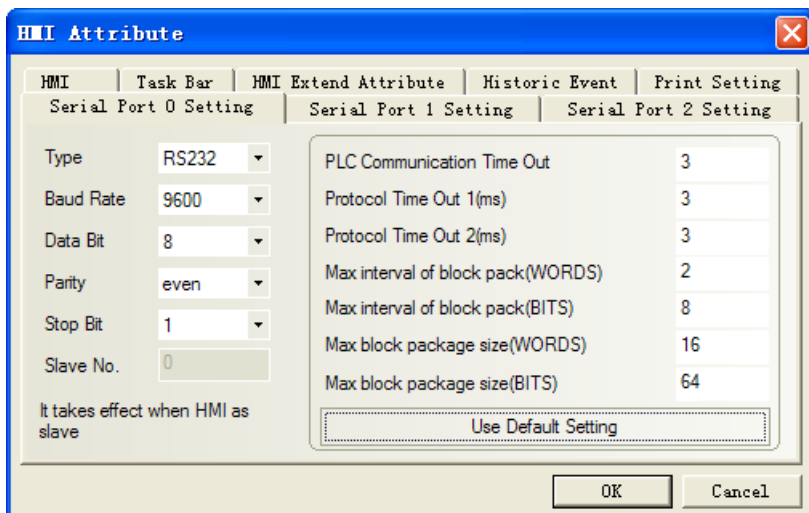

RS485 communication

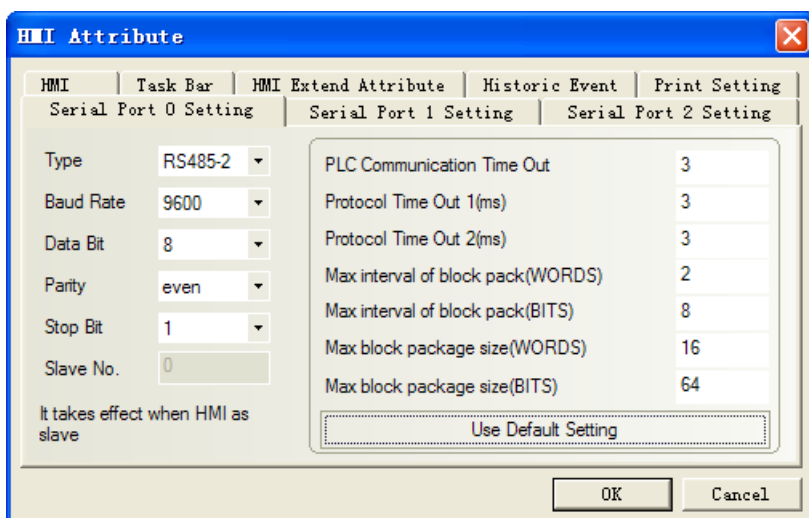

PLC Setting

PL7 software setting

1. Start menu → “modicum telemecanique” → “XWAY Driver Manager” to set communication parameter

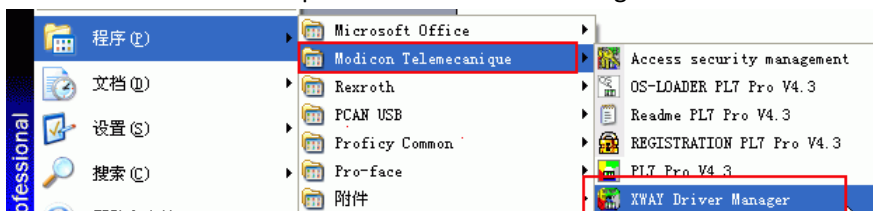

2. Pop-up to select “UNITELWAY Driver” → “Configuration” → “Edit” to modify communication parameter



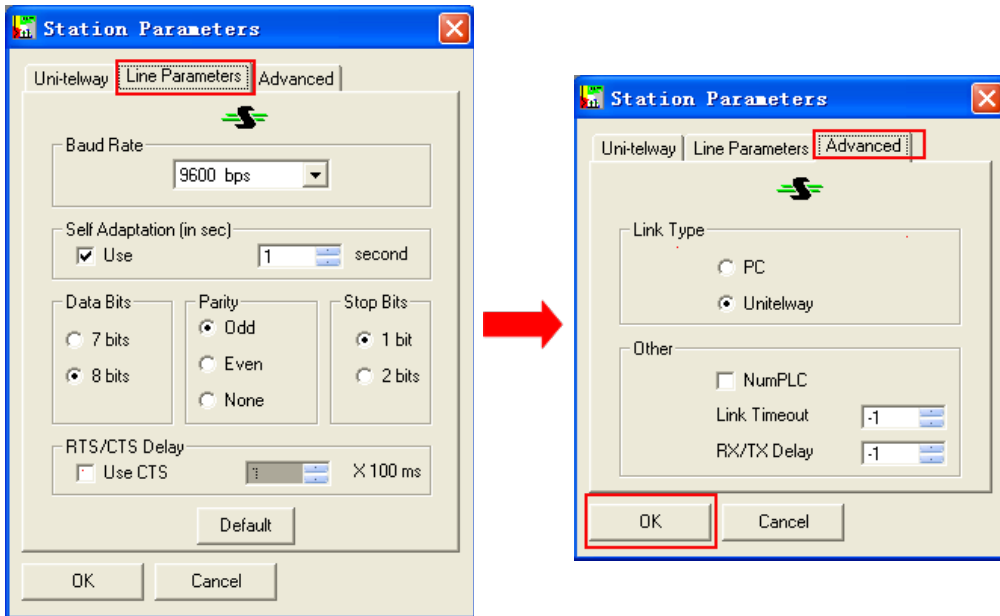
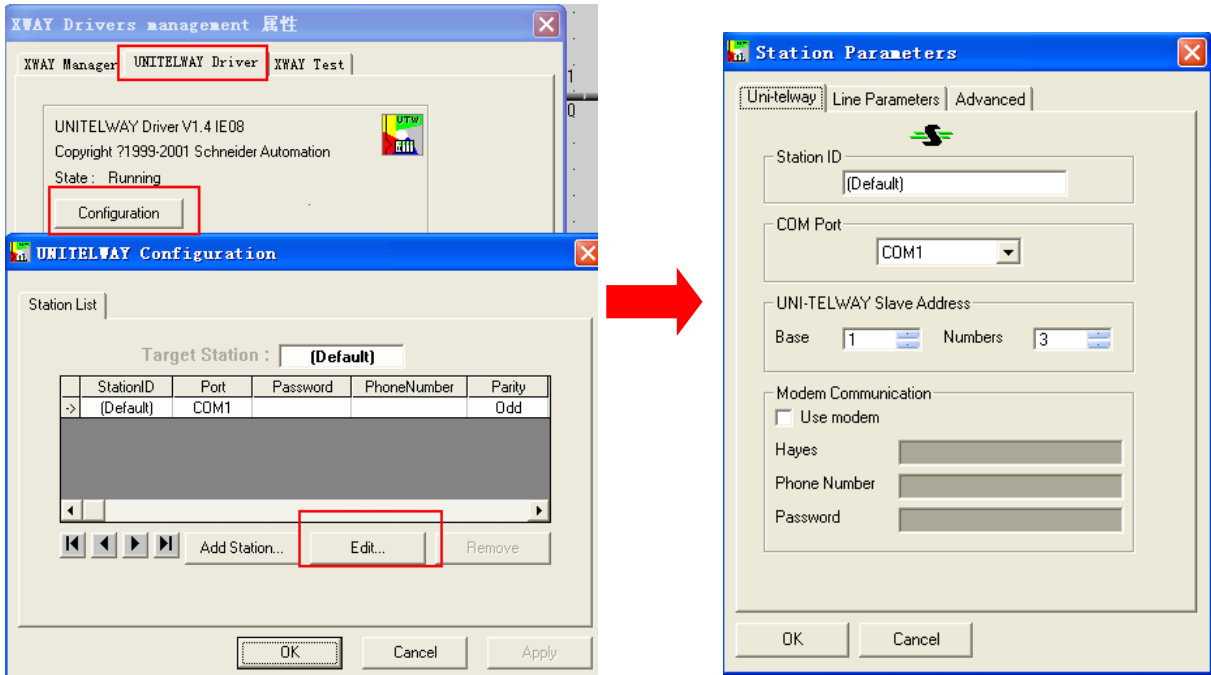

3. Press "OK" and pop up the following tips

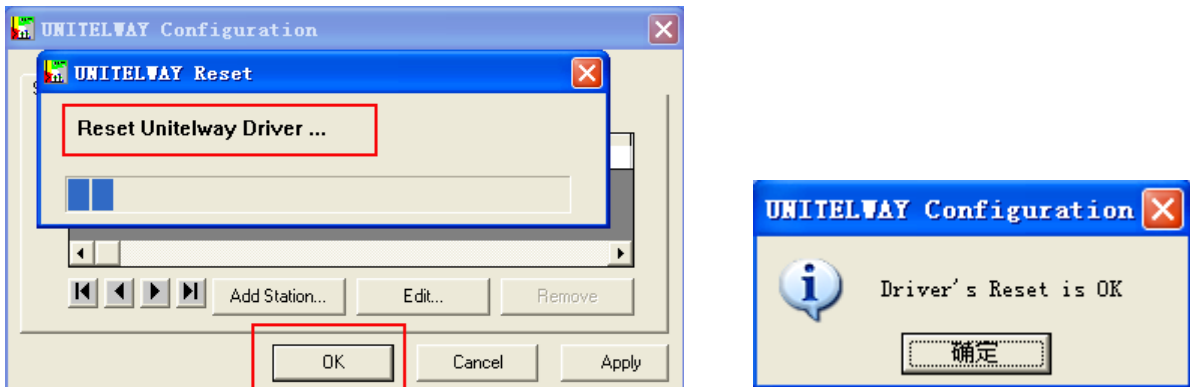

4. And then click "XWAY Test" → "Connect", if the connection is successful, it will clue "Connected"



5. Open the PL7 software → "Create new project" → click "Hardware configuration" → double-click pop-up window "Comm"

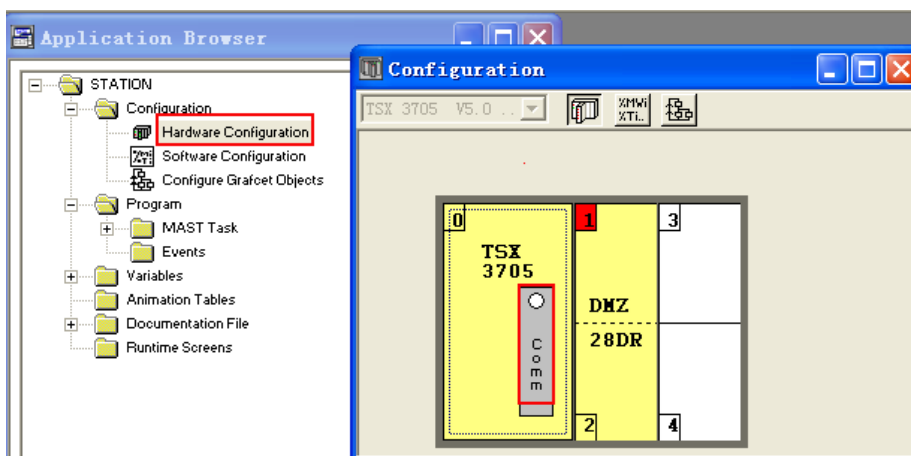

Unitel-way protocol setting as follow:

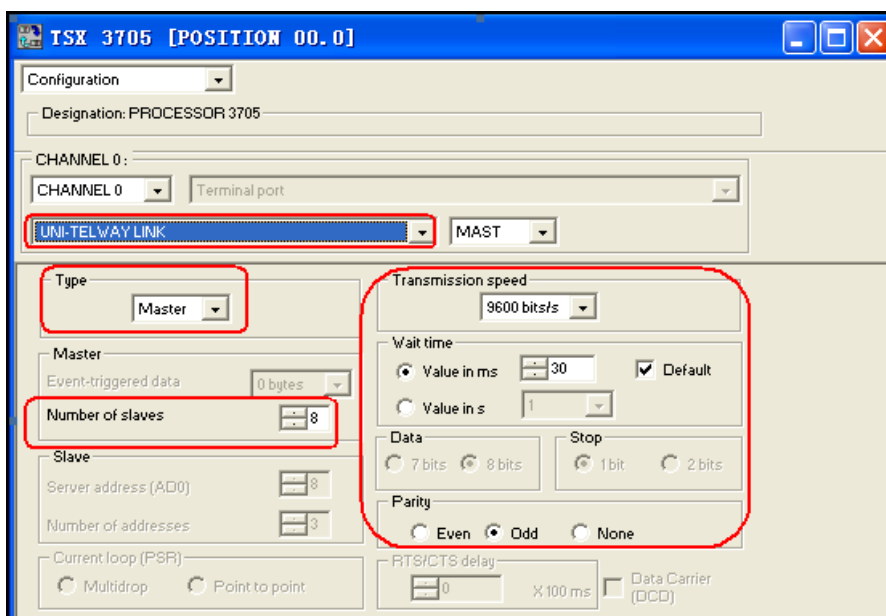

Modbus RTU protocol setting as follow:

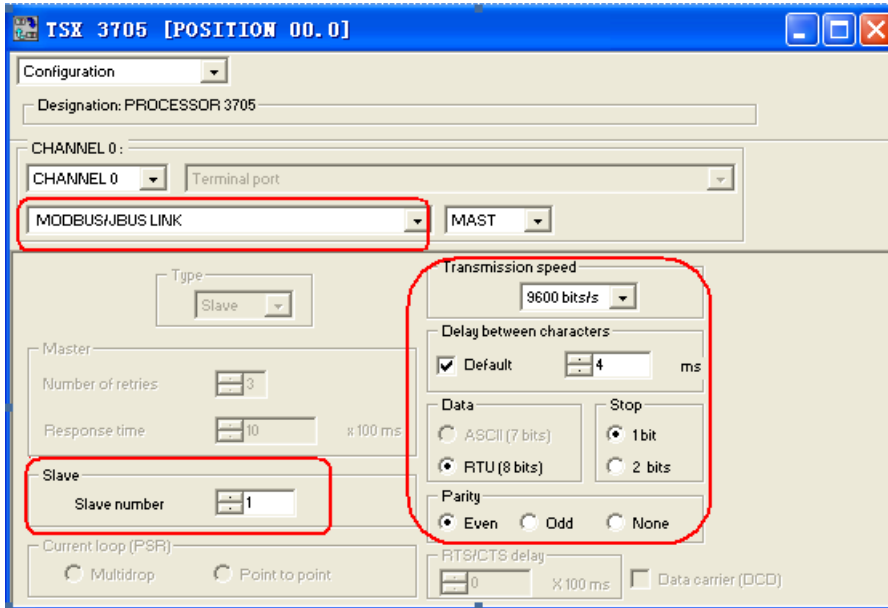

6. Setting up the configuration and download the project to the PLC

### Schneider Twido Modbus RTU protocol

Default communication: 19200, 8, none, 1; station: 1

**NOTE:** Cable by Schneider Electric Industries, Rotary switch setting: 2(TER Direct).

[RS232 communication](#)

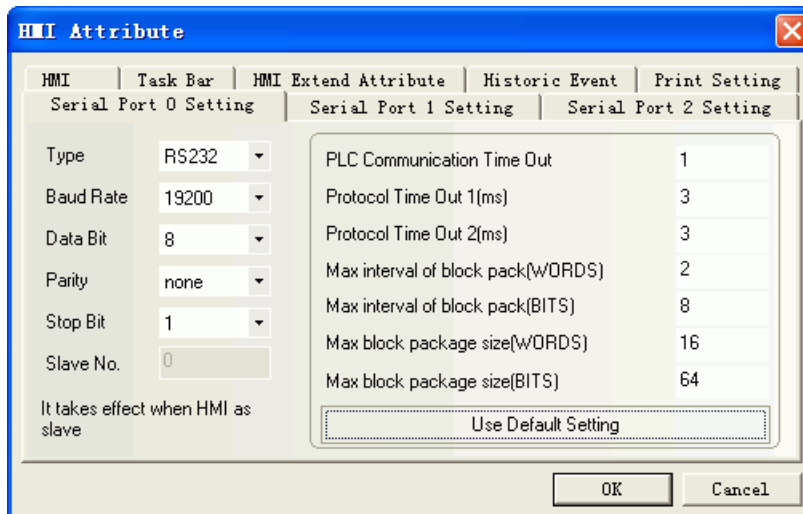

[RS485 communication](#)

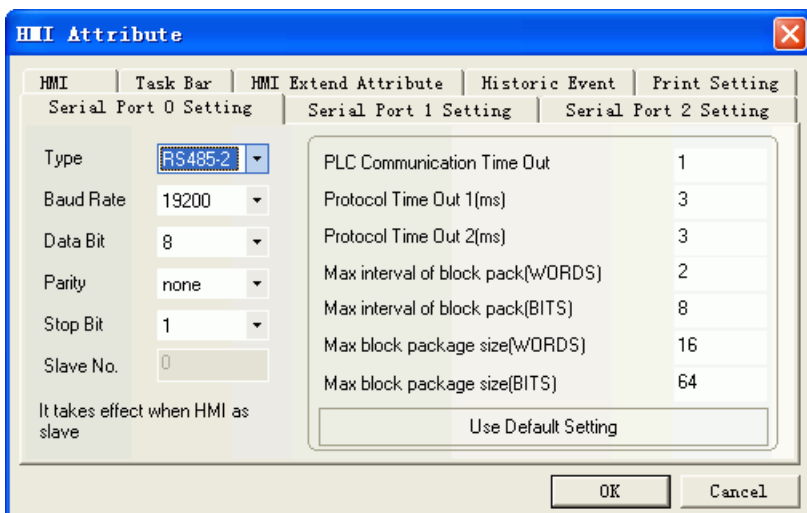

### PLC Setting

1. Specify a large number for the internal word in the “Controller → Memory Use →Edit” and load the configuration into the PLC to open the memory area for the words. If set the internal word 3000, you can use address of MW before 3000.

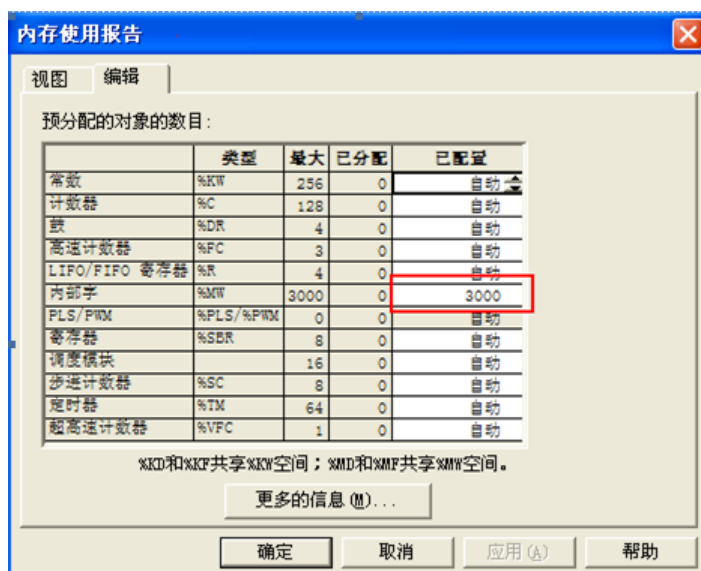

2. You must program a coil with maximum address to open the memory area for the Bits. If you program a coil with 127 addresses, then the address before 127 can be used.



### Schneider M Series protocol

Default communication: 9600, 8, odd, 1; station:1

[RS232 communication](#)

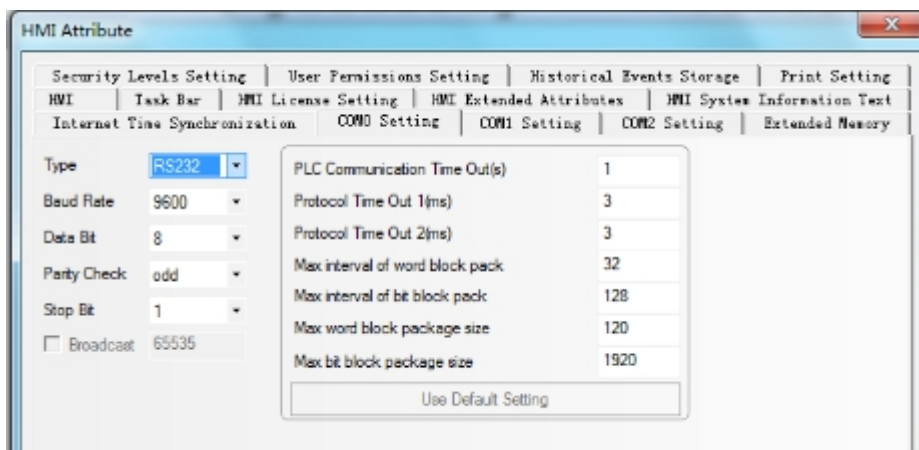

### RS485 communication

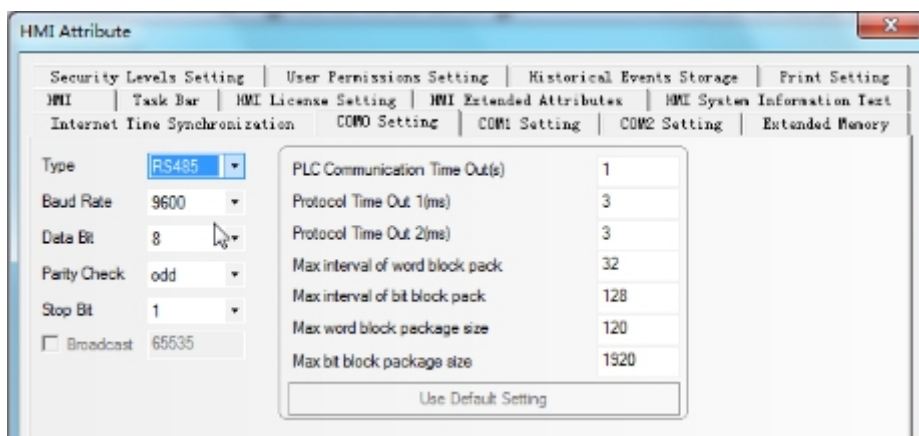

## PLC Setting

### Somachine software setting

1. In Somachine software, choose and link to the same type PLC ,then create a new program.

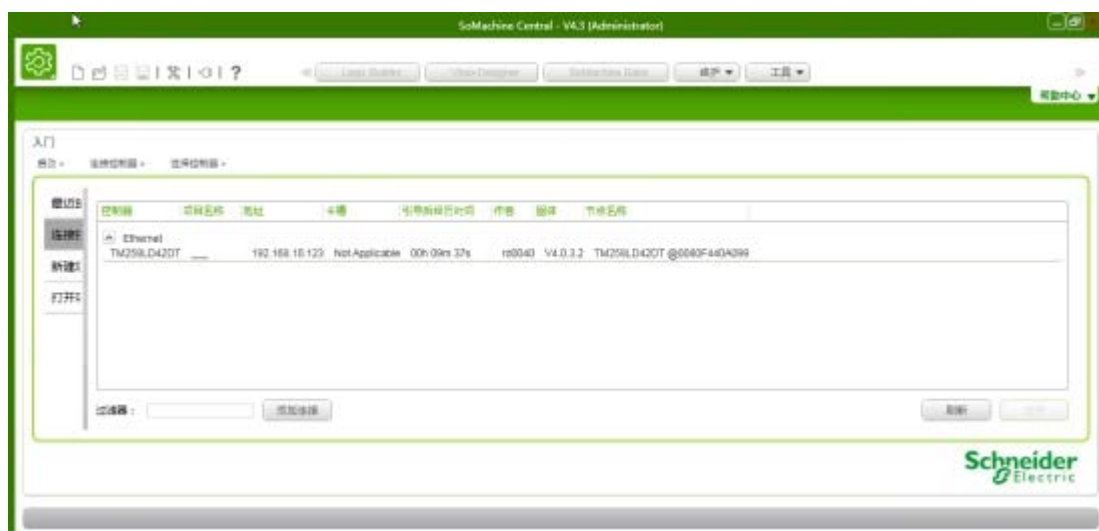

2. After creating a new program, right click [ Serial Line] and choose add device

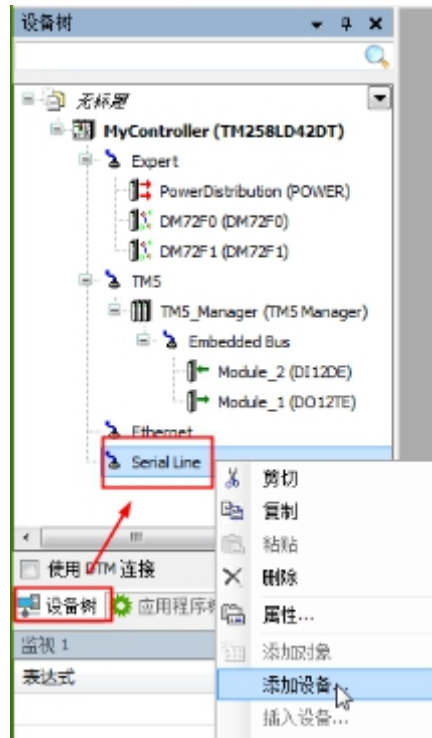

In the add device window, choose Modbus Manager and click [add device]

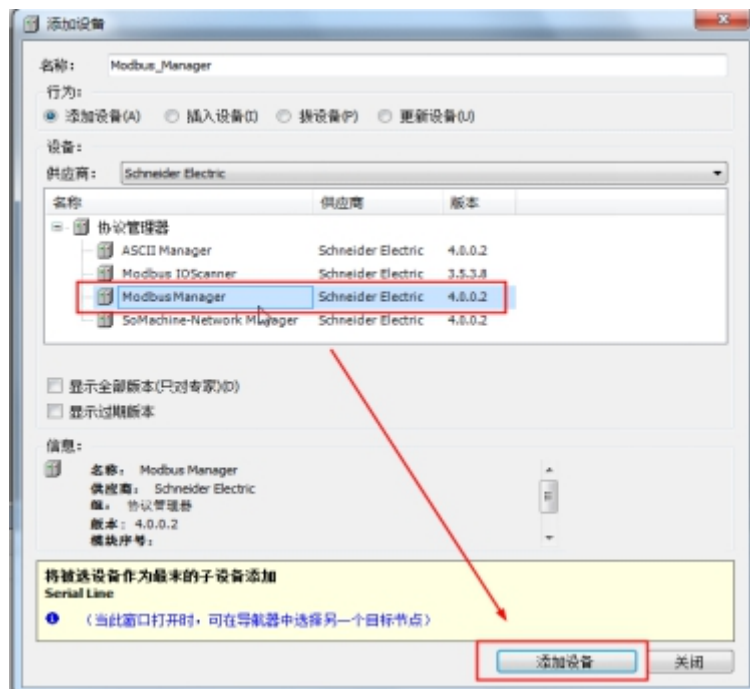

3. Double click [Serial Line]>[Modbus Manage], complete the parameter setting, click [online] and [log on].

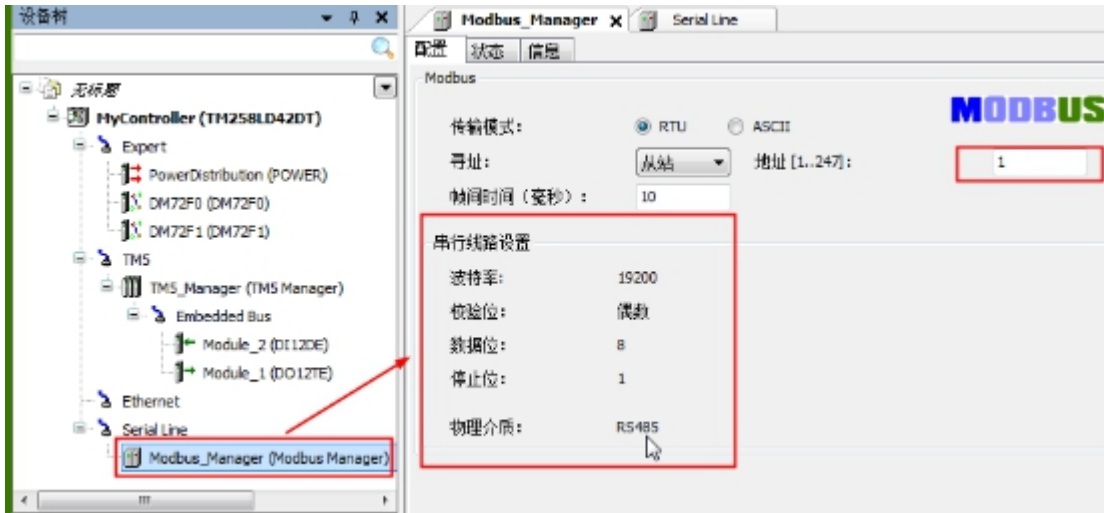

4. when need to change the type of communication, double click [Serial Line] and choose in the right region.

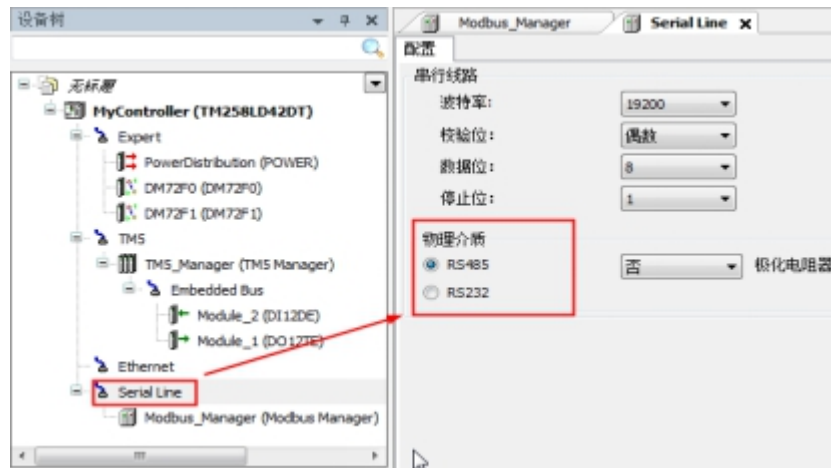

5.If you want to monitor the internal data of the controller,click [View]>[Monitor] and choose a monitor sheet.

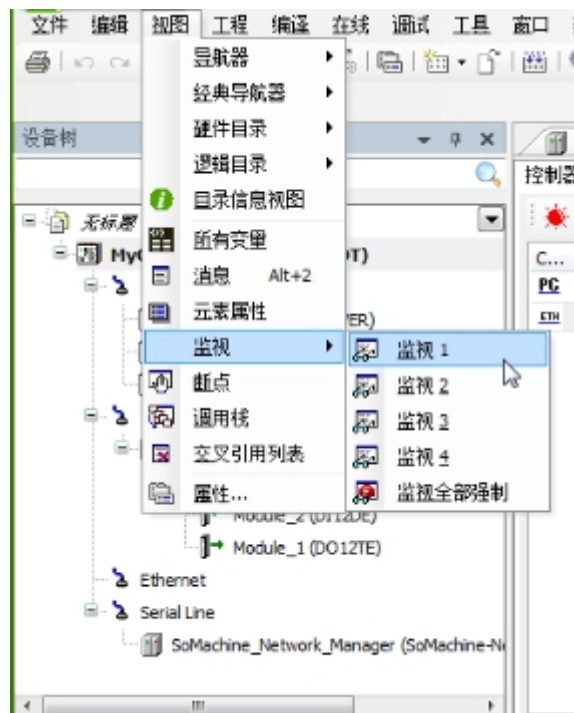

## ◎ Network Communication Setting

### HMI Setting

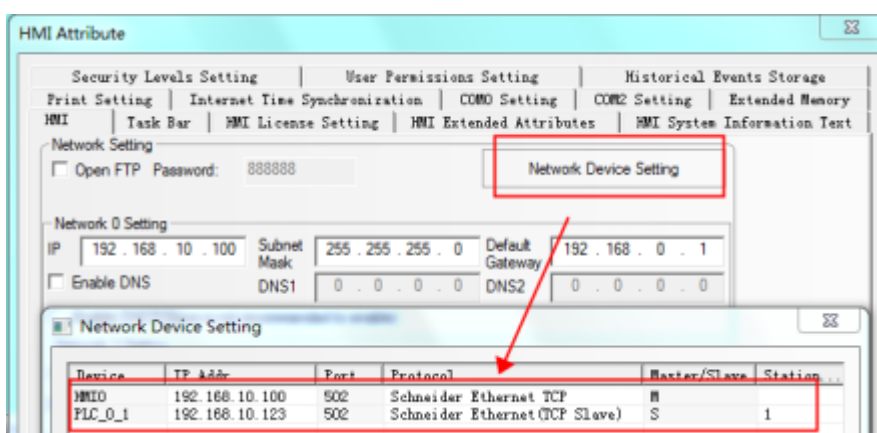
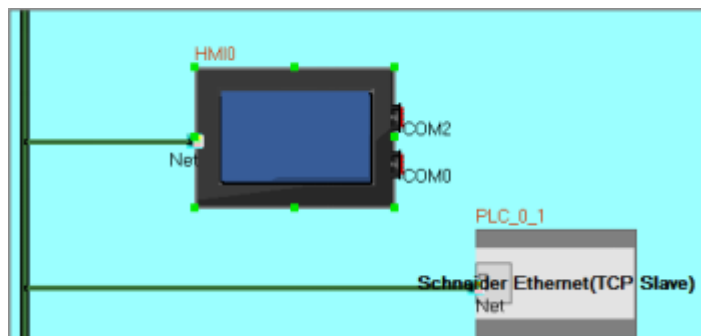

### PLC Setting

1. In Somachine software, choose and link to the same type PLC, then create a new program.

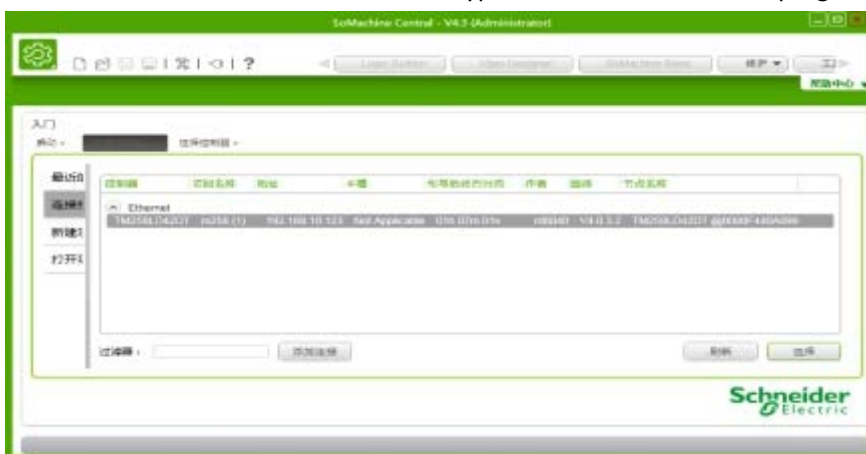

2. If you need to change the IP Address of the PLC, double click [Ethernet] then complete the IP Address configuration. (Attention: Subnet mask and Gateway address should be set up correctly, and choose Ethernet II protocol.)



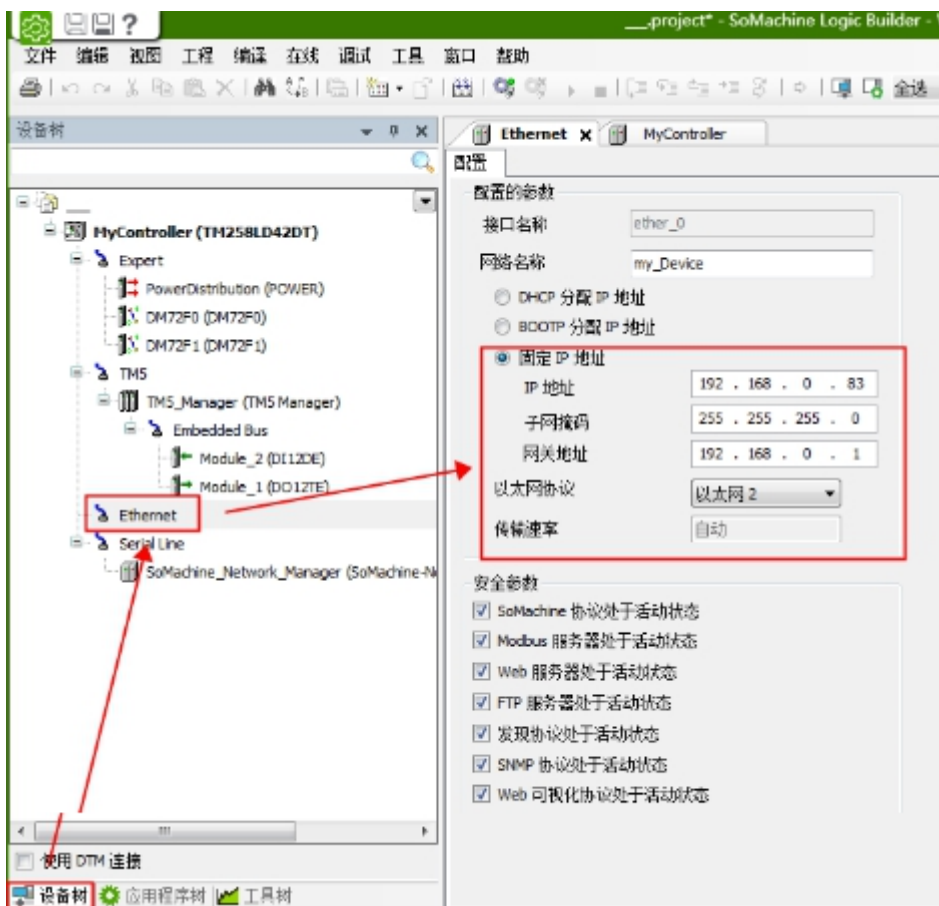

3.If you don't need to change the IP Address of the PLC, double click [Mycontroller]then choose the right model PLC, click [online]and [log on].

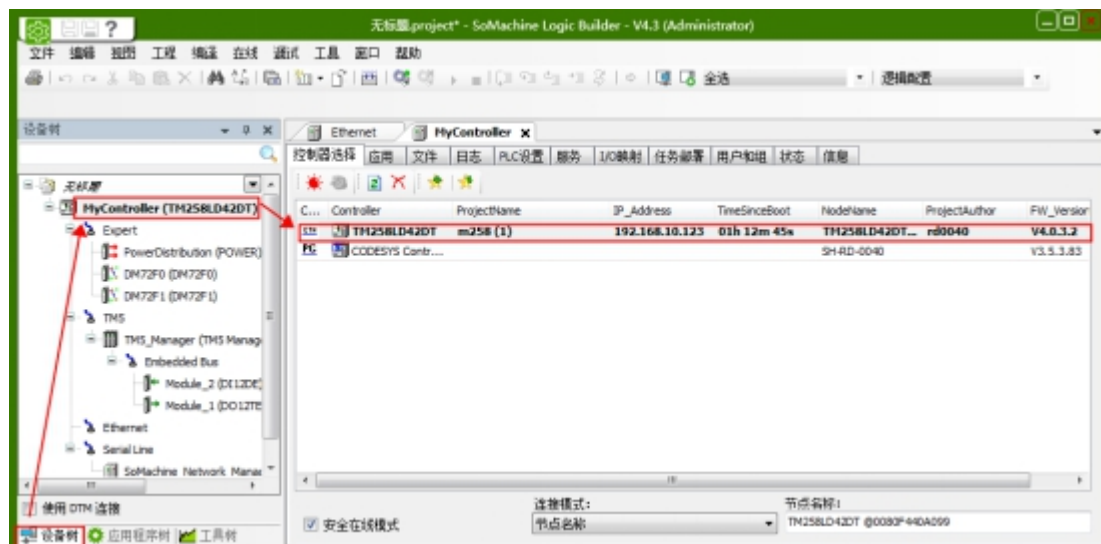

4.If you want to monitor the internal data of the controller,click [View]>[Monitor] and choose a monitor sheet.

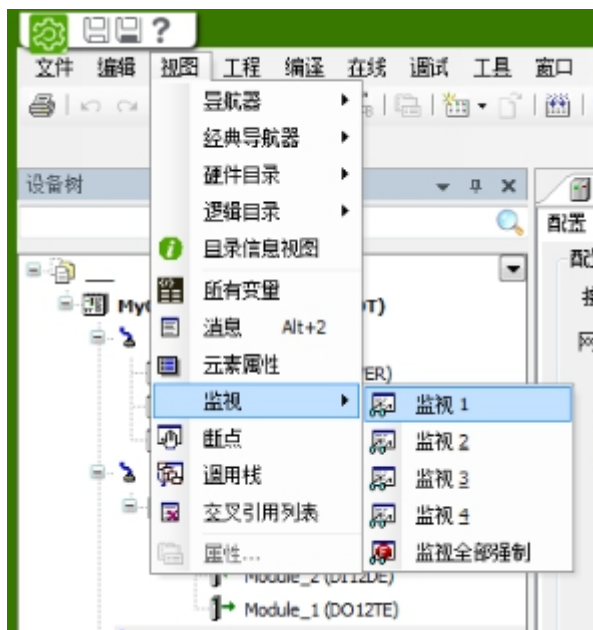

## ◎ Supported Device

### Modicon TSX

Device	Bit Address	Word Address	Format	Notes
Internal Relay	S00000-32767	-----	DDDDD	
Auxiliary Relay	M00000-32767	-----	DDDDD	
Data Register Relay	MW.B0000-9999.F	-----	DDDD.H	
Data register	-----	MW0000-7999	DDDD	
Data register double word	-----	MD0000-7999	DDDD	

### Twido

Device	Bit Address	Word Address	Format	Notes
Output Relay	0X 1-9999	-----	DDDD	
Input Relay (read only)	1X 1-9999	-----	DDDD	
Input Register (read only)	-----	3X 1-9999	DDDD	
Output Register	-----	4X 1-9999	DDDD	

#### NOTE:

The M register in the software of TWIDO corresponds to 0X in the ev5000 software; MW corresponds to 4X. The HMI's address must plus 1 to correspond with the address of PLC.

e.g.: M0 corresponds to 0X1.

Don't use 1X, 3X device, because there is no correspondence with the PLC.

### M Series

Device	Bit Address	Word Address	Format	Notes
Input	IX0.0-4095.7	-----	DDDD.O	Read only
Output	QX0.0-4095.7	-----	DDDD.O	

Data Register Relay	MX0.0-11999.7	-----	DDDDDD.O	
Data register	-----	MW00000- 59999	DDDDD	
Data register double word	-----	MD00000-29999	DDDDD	

### © Cable Diagram

#### Uni-TelWay protocol

##### RS232 communication cable

Cable recommended by Schneider Electric Industries, Rotary switch setting: 2(TER Direct) (Add a direct line)

##### RS485 communication cable

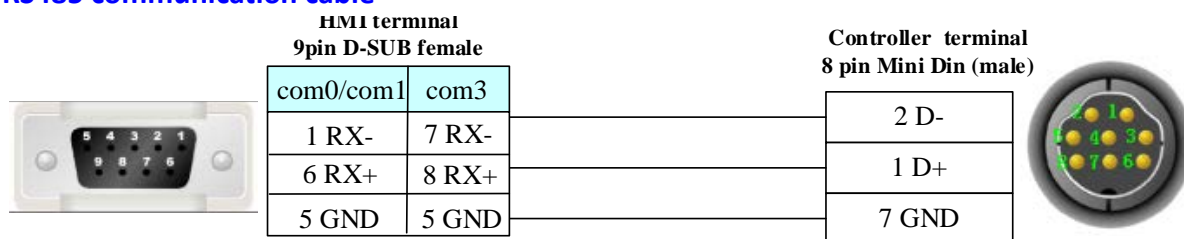

#### Modicon modbus protocol

##### RS232 communication cable

PLC software setting: "Hardware Configuration" → double click "Ccom" to select "MODBUS/BUS LINK"; others are default parameters.

Cable recommended by Schneider Electric Industries, Rotary switch setting: 3 (OTHER Direct)

##### RS485 communication cable

PLC software setting: "Hardware Configuration" → double click "Ccom" to select "MODBUS/BUS LINK"; Others are default parameters.

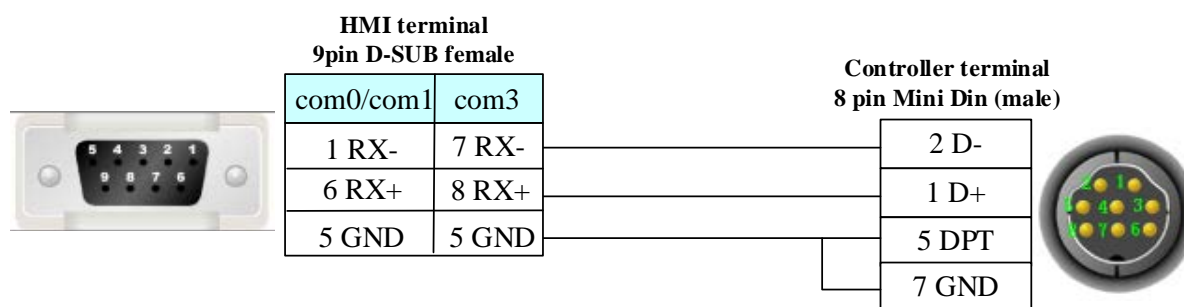

#### Schneider Twido Modbus RTU protocol

##### RS232 communication cable

Cable recommended by Schneider Electric Industries

##### RS485 communication cable

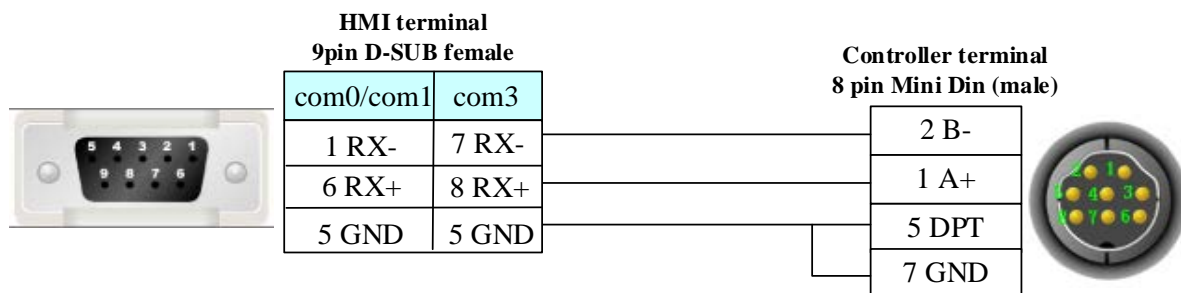

**Schneider M Series protocol**

**RS232 communication cable**

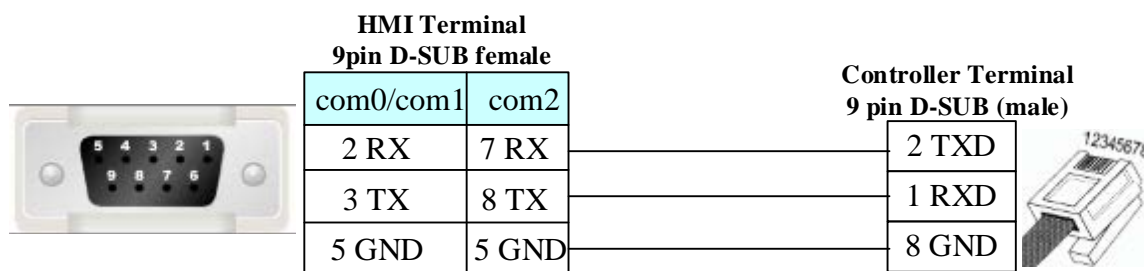

**RS485 communication cable**

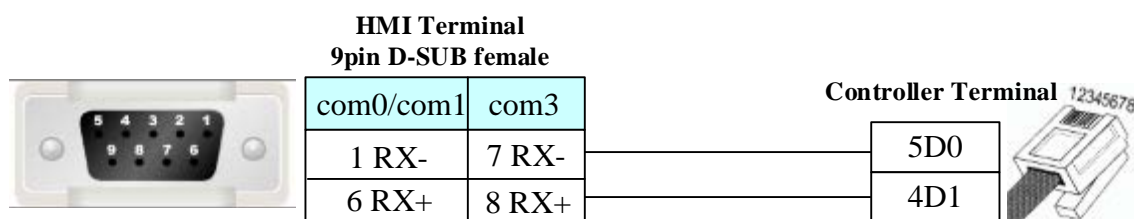

**Ethernet communication protocol cable**

Cross-connection or crossover network cable can be used as communication cable via the hub

Refer to [3.3 Download by Network Ethernet](#) for method of making connection cable.

**4.72 SHIMADEN**

◎ **Serial Communication**

Series	CPU	Link Module	Driver
FP23	FP23	RS485 on the CPU unit	SHIMADEN FP23
MR13	FP23	RS485 on the CPU unit	SHIMADEN MR13

◎ **System configuration**

Series	CPU	Link Module	COMM Type	Parameter	Cable
FP23	FP23	RS485 on the CPU unit	RS485	<a href="#">Setting</a>	<a href="#">Your owner cable</a>
MR13	MR13	RS485 on the CPU unit	RS485	<a href="#">Setting</a>	<a href="#">Your owner cable</a>

## ◎ Communication Setting

### SHIMADEN FP23

Default communication parameters: 9600, 8, even, 1; station: 1

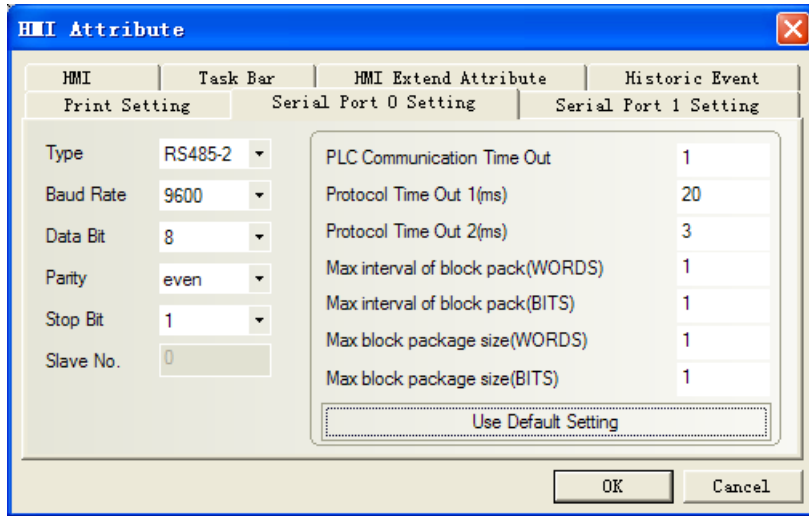

### SHIMADEN MR13

#### HMI Settings

Default communication parameters of HMI

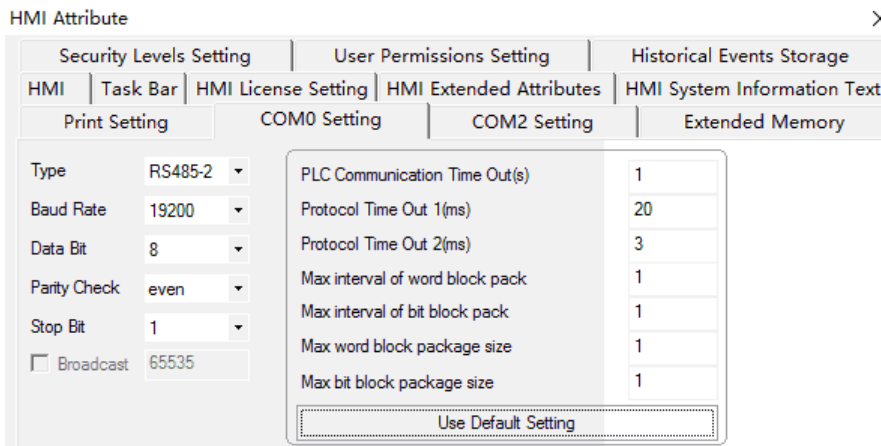

#### NOTE:

1. When communicating with COM mode, you should first put the 18C address 1, and then open the COM communication mode to communicate successfully. The bool element address is set to 1.18C, as shown in the following figure:

## Multi-State Setting Component Attribute

## PLC Settings

Please refer to relevant instructions of communication equipment for related parameter settings.

- 【1-14B】 PLC Station No.;
- 【1-15B】 Baud Rate;
- 【1-16B】 Data Bits、Parity、 Stop Bits;
- 【1-18B】 Start Character Mode, Select 2: STX\_ETX\_CRLF;
- 【1-19B】 BCC Operation Method, Select 1: ADD;

## ◎ Supported Device

### FP23

Device	Bit Address	Word Address	Format
State instructions(Write Only)	Ctrl_Write 184-252	-----	HHH
Sequence code(Read Only)	-----	Array Code 0-3	H
Basic parameter value (Read Only)	-----	Basic_Read 00-42	HH
OUT1_W,OUT2_W(Write Only)	-----	Out_Write 0-1	H
PV1, PV2 (Read Only)	-----	PV_Read 0-1	H
Reference (Read & Write)	-----	Reference 300-952	HHH

### Basic\_Read operatable address

PLC addr (HEX)	Parameter	R/W	Parameters mean
00H	PV_W	Read	Measurements
01H	SV_W	Read	Setting value
02H	OUT1_W	Read	Output1 value
03H	OUT2_W	Read	Output2 value
04H	EXE_FLG	Read	Execute_flag (no execute=0)
05H	EV_FLG	Read	Event_flag (no event output 0000)
06H	Reserve	Read	value:0000H
07H	EXE_PID	Read	Execute_PID No.
09H	HB_W	Read	Heater break alarm
0AH	HL_W	Read	Heater loop alarm
0BH	DI_FLG	Read	DI status flag

10H	UNIT	Read	Measurement unit
11H	RANGE	Read	Measuring range
12H	CJ	Read	Cold junction compensation 0=Internal 1=External
13H	DP	Read	Decimal position, 0=none 1=0.1 2=0.01 3=0.001 4=0.0001
14H	SC_L	Read	PV lower limit side scaling
15H	SC_H	Read	PV higher limit side scaling
16H	DPFLG	Read	0=show 1=cancel
20H	E_PRG	Read	Execute flag of program
21H	E_PTN	Read	Execution step No. of step loop
22H	Reserve	Read	Reserve
23H	E_RPT	Read	Curve repeat time
24H	E_STP	Read	Execution count of step loop
25H	E_TIM	Read	Step time
26H	E_PID	Read	PID No. execution
29H	E_STPRPT	Read	Number of steps
42H	POSI	Read	Seven switches (feedback 0-100)

#### Ctrl\_Write operatable address example

PLC addr (HEX)	Parameter	R/W	Parameters mean
184H	AT	write	Execution automatically adjustment 0: OFF1: ON
18CH	COM	write	Communication Protocol: 0: LOC 1: COM

#### Reference operatable address example

PLC Addr (HEX)	Parameter	R/W	Parameters mean
300H	FIX_SV	R/W	FIX mode SV: in the limit range of SV
460H	PB21	R/W	ratio coefficient: 0.0 to 999.9%(0.0=OFF)

About device address details, please refer to the FP23 communication protocol.

**Show: H indicates HEX**

**Note:** 1、Setting the parameters of ADDR address, the settings must be the same as the corresponding PLC station.

2、When Connecting multiple instruments, for distinguishing instruments, each instrument must be set different ADDR value.

#### MR13

Device	Bit Address	Word Address	Format	Notes
State instructions(Write Only)	Ctrl_Write 1.184-3.252	-----	HHH	
Sequence code(Read Only)	-----	Array Code1.000-3.003	D.HHH	
Basic parameter value (Read Only)	-----	Basic_Read 1.000-3.042	D.HHH	<a href="#">settings</a>
OUT1_W,OUT2_W(Writ	-----	Out_Write	D.HHH	

e Only)		1.000-3.001		
PV1, PV2 (Read Only)	-----	PV_Read 1.000-3.002	D.HHH	PV1(1.0;2.0;3.0) PV2(1.1;2.1;3.1) PV3(1.2;2.2;3.2)
Reference (Read & Write)	-----	Reference 1.100-3.952	D.HHH	<a href="#">settings</a>

(Example: In address 1.184, "1" is the channel address, "2" is the control address, and the communication mode is chosen as the public address, regardless of the channel. The address is set to 1.184(AT mode)and1.18C(COM mode) by default.)

### Basic\_Read 可操作地址

Examples: Address "1.2", "1" is the channel address, and "2" is the control address

PLC Address (HEX)	Parameter	Read/Write	Meanings of Parameter	Remark /Example for 3 channel address
01H	SV_W	Read	Setting values	1.1; 2.1; 3.1(setting values of three channels)
02H	OUT_W	Read	Limits of output control	1.2; 2.2; 3.2
04H	EXE_FLG	Read	Execution flag	Non execution =0
05H	EV_FLG	Read	Event output flag bit	Non event output=0000
06H	Retain	Read	The value is fixed to 0000H	
07H	EXE_PID	Read	The current executed PID number	
09H	HB_W	Read	Heater disconnection alarm value	
0AH	HL_W	Read	Undercurrent alarm value	
0BH	DI_FLG	Read	DI switch status flag bit	
10H	UNIT	Read		0=°C;1=°F;2=% 3=K; 4=NONE
11H	RANGE	Read	Measuring range	
12H	CJ	Read	Cold junction compensation	0=Internal; 1=External
13H	DP	Read	Position of decimal point	0=None; 1=0.1; 2=0.01.....
14H	SC_L	Read	Lower limit of measuring range	
15H	SC_H	Read	Higher limit of measuring range	
16H	DPFLG	Read	Digital decimal place	0=Display ; 1=Cancel
20H	E_PRG	Read	Program execution tagging	
21H	E_PTN	Read	The currently executed curve number	
22H	Retain	Read	Retain	
23H	E_RPT	Read	Curve repeat number	
24H	E_STP	Read	Current executed step of the curve	
25H	E_TIM	Read	The remaining time of the current executed step	
26H	E_PID	Read	The current executed PID	



			number	
29H	E_STPRPT	Read	Program execution steps	
42H	POSI	Read	Seven switching quantities	

#### Ctrl\_Write: Operable address examples

PLC Address (HEX)	Parameter	Read/Write	Remark /Example for 3 channel address
184H	AT	Write	Self-tuning function, 0=OFF;1=ON
18CH	COM	Write	COM function: 0=Local; 1=COM

(Example: In address 1.184, "1" is the channel address, "2" is the control address, and the communication mode is chosen as the public address, regardless of the channel. The address is set to 1.184(AT mode)and1.18C(COM mode) by default.

#### Reference: Operable address examples

PLC Address (HEX)	Parameter	Read/Write	Note
100H	PV(Measuring values )	Read	Example: 1.100; 2.100; 3.100
101H	E_SV(Setting values)	Read	Example: 1.101; 2.101; 3.101
184H	AT(Self tuning)	Write	0: Stop; 1: Execute
18CH	COM(Communication state )	Write	0: Local communication 1: COM Communication
...	...	...	...
8C2	The ninth step number of PID	Read/Write	1.8C2, 2.8C2, 3.8C2

Example: In address 1.184, "1" is the channel address, "2" is the control address, and the communication mode is chosen as the public address, regardless of the channel. The address is set to 1.184(AT mode)and1.18C(COM mode) by default.

For other parameters, refer to 《mr13 communication protocol 》 , at the sixth section of the communication data address table.

#### Notice:

- 1.When you set the parameter address of communication,the setting value must be the same as the station number of the corresponding PLC.
- 2.In the case of connecting multiple meters, a different parameter address value is required for each instrument to distinguish between different instruments.

## © Cable Diagram

### FP23

FP23 programmable PID regulator of 8 point and 10 point must be shorted or communications failure

### RS485 communication cable

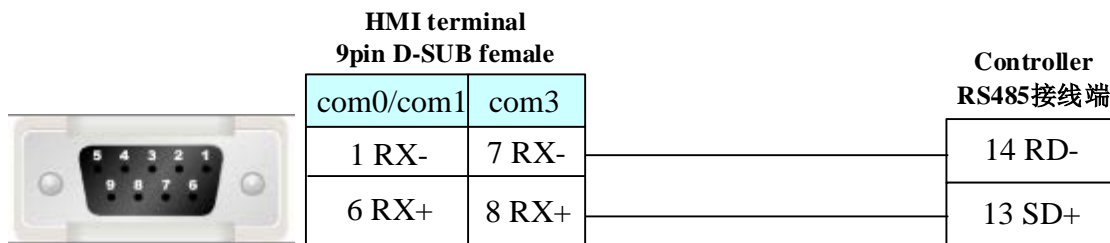

MR13

RS485:Communication cable

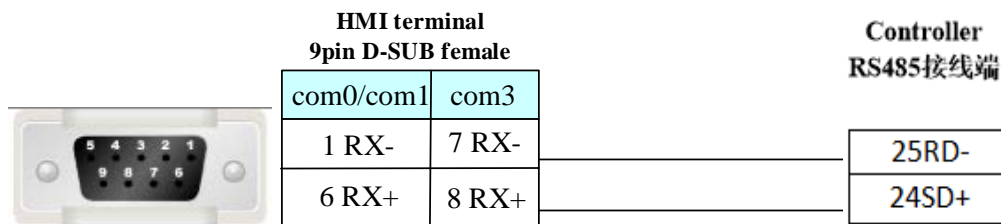

## 4.73 SIEMENS

### ◎Serial Communication

Series	CPU	Link Module	Driver
S7-200	CPU212	RS485 on the CPU unit	SIEMENS S7-200
	CPU214		
	CPU215		
	CPU216		
	CPU221		
	CPU222		
	CPU224		
	CPU226		
	CPU224 XP CN		
	CPU226 XP CN		
S7-200 SMART	CR40	RS485 on the CPU unit	
	SR20		
S7-300	CPU312IFM	MPI port on the CPU unit	SIEMENS S7-300/400 (PC Adapter Direct)  SIEMENS S7-300/400 (MPI Direct) *1
	CPU313		
	CPU313C		
	CPU314		
	CPU314IFM		
	CPU315		
	CPU315-2 DP		
	CPU316		
	CPU316-2 DP		
	CPU318-2		

S7-400	CPU412-1 CPU412-2 DP CPU412-3H CPU413-1 CPU413-2 DP CPU414-1 CPU414-2 DP CPU414-3 DP CPU416-1 CPU416-2 DP CPU416-3 DP CPU417-4	MPI port on the CPU unit	
S7-300	CPU312IFM CPU313 CPU313C CPU314 CPU314IFM CPU315 CPU315-2 DP CPU316 CPU316-2 DP CPU318-2	MPI port on the CPU unit	SIEMENS MPI*2

**NOTE**

- \*1 :The protocol is suitable for the MT5020 series with MPI extended port. This protocol supports multi HMI to multi PLC communication
- \*2 : The protocol is suitable for the MT4000 series HMI in 2013 November factory. This protocol supports one HMI to one PLC communication

### © Ethernet Communication (Direct online simulation disable)

Series	CPU	Link Module	Driver
SIMATIC S7-200	CPU222 CPU224 CPU224 XP CPU226	CP 243-1 IT CP 243-1	SIEMENS S7-200 Ethernet (TCP Slave)
SMART S7-200	CR40 SR20	Ethernet interface on CPU	SIEMENS S7-200 SMART Ethernet (TCP Slave)
SIMATIC S7-1200	CPU1214C	CPU	SIEMENS S7-1200 /1500 Ethernet (TCP Slave)
SIMATIC S7-1500	CPU1511-1 PN	CPU	
SIMATIC S7-300	CPU315-2DP	CP 343-1 IT CP 343-1	SIEMENS S7-300 Ethernet (TCP Slave)
	CPU315-2 PN/DP CPU317-2 PN/DP CPU319-3 PN/DP	Ethernet interface on CPU	

SIMATIC S7-400	CPU412-1 CPU412-2 DP CPU412-3H CPU413-1 CPU413-2 DP CPU414-1 CPU414-2 DP CPU414-3 DP CPU416-1 CPU416-2 DP CPU416-3 DP CPU417-4 CPU414-3 PN/DP CPU416-3 PN/DP	CP 443-1 IT CP 443-1	SIEMENS S7-400 Ethernet (TCP Slave)
	CPU414-3 PN/DP CPU416-3 PN/DP	Ethernet interface on CPU	
SIEMENS LOGO!	6ED1 052-1MD00-0AB8	Ethernet interface on CPU	SIEMENS LOGO! Ethernet(TCP Slave)

### ◎ BUS Communication

Please refer to [4.59 Profibus DP Slave](#).

### ◎ Serial System configuration

Series	CPU	Link Module	COMM Type	Parameter	Cable
S7-200	CPU222 CPU224 CPU226 CPU224 XP CN CPU226 XP CN	RS485 on the CPU unit	RS232	<a href="#">Setting</a>	<a href="#">Your owner cable</a>
	RS485		<a href="#">Setting</a>	<a href="#">Your owner cable</a>	
S7-200 SMART	CR40 SR20	RS485 on the CPU unit	RS485	<a href="#">Setting</a>	<a href="#">Your owner cable</a>
S7-300	CPU312IFM CPU313 CPU313C CPU314 CPU314IFM CPU315 CPU315-2 DP CPU316 CPU316-2 DP	MPI port on the CPU unit	RS232 S7-300/400 (PC Adapter Direct) protocol	<a href="#">Setting</a>	<a href="#">Your owner cable</a>
			RS485 S7-300/400 (MPI Direct) protocol	<a href="#">Setting</a>	<a href="#">Your owner cable</a>

	CPU318-2		RS485 SIEMENS MPI protocol	<a href="#">Setting</a>	<a href="#">Your owner cable</a>
S7-400	CPU412-1 CPU412-2 DP CPU412-3H CPU413-1 CPU413-2 DP CPU414-1 CPU414-2 DP CPU414-3 DP CPU416-1 CPU416-2 DP CPU416-3 DP CPU417-4	MPI port on the CPU unit	RS232 S7-300/400 (PC Adapter Direct) protocol	<a href="#">Setting</a>	<a href="#">Your owner cable</a>
			RS485 S7-300/400 (MPI Direct) protocol	<a href="#">Setting</a>	<a href="#">Your owner cable</a>

### ◎ Ethernet System configuration

Series	CPU	Link Module	Connect Type	Parameter	Cable
SIMATIC S7-200	CPU222 CPU224 CPU224 XP CPU226	CP 243-1 IT CP 243-1	Ethernet	<a href="#">Setting</a>	<a href="#">Your owner cable</a>
SIMATIC S7-200 SMART	CR40 SR20	Ethernet interface on CPU	Ethernet	<a href="#">Setting</a>	<a href="#">Your owner cable</a>
SIMATIC S7-1200	CPU1214C	CPU	Ethernet	<a href="#">Setting</a>	<a href="#">Your owner cable</a>
SIMATIC S7-1500	CPU1511-1 PN	CPU			
SIMATIC S7-300	CPU315-2DP	CP 343-1 IT CP 343-1	Ethernet	<a href="#">Setting</a>	<a href="#">Your owner cable</a>
	CPU315-2 PN/DP CPU317-2 PN/DP CPU319-3 PN/DP	Ethernet interface on CPU			
SIMATIC S7-400	CPU412-3H	CP 443-1 IT CP 443-1	Ethernet	<a href="#">Setting</a>	<a href="#">Your owner cable</a>
SIEMENS LOGO!	6ED1 052-1MD00-0AB8	Ethernet interface on CPU	Ethernet	<a href="#">Setting</a>	<a href="#">Your owner cable</a>

### ◎ Serial Communication Setting

#### SIEMENS S7-200 protocol

Default communication parameters: 9600, 8, 1, even; station No.: 2.

**NOTE:** HMI Baudrate can reach to 187.5k, but don't support online simulate for 187.5K.

[RS232 communication](#)

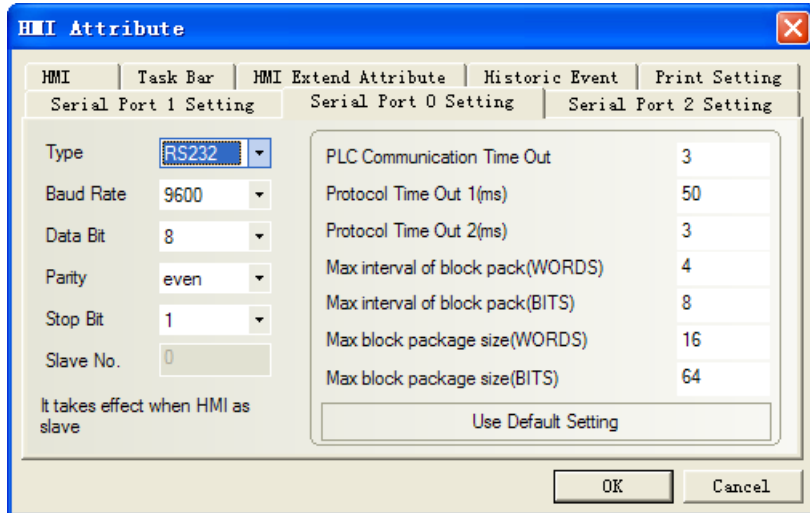

RS485 communication

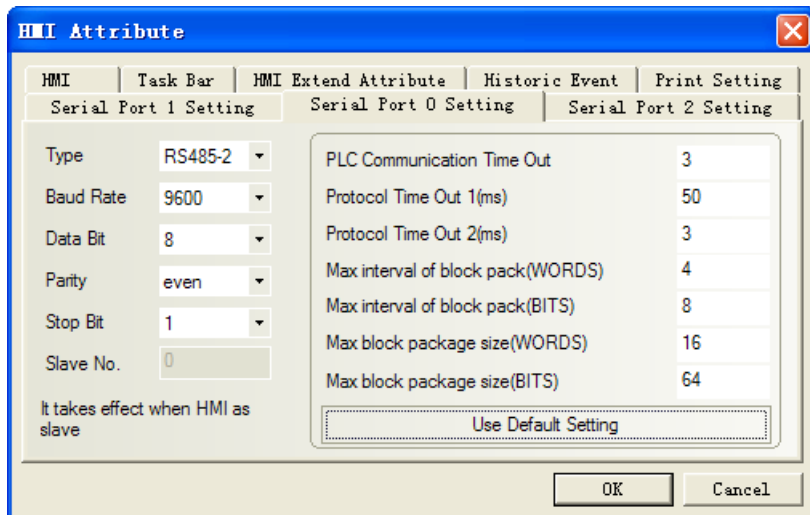

PLC Setting

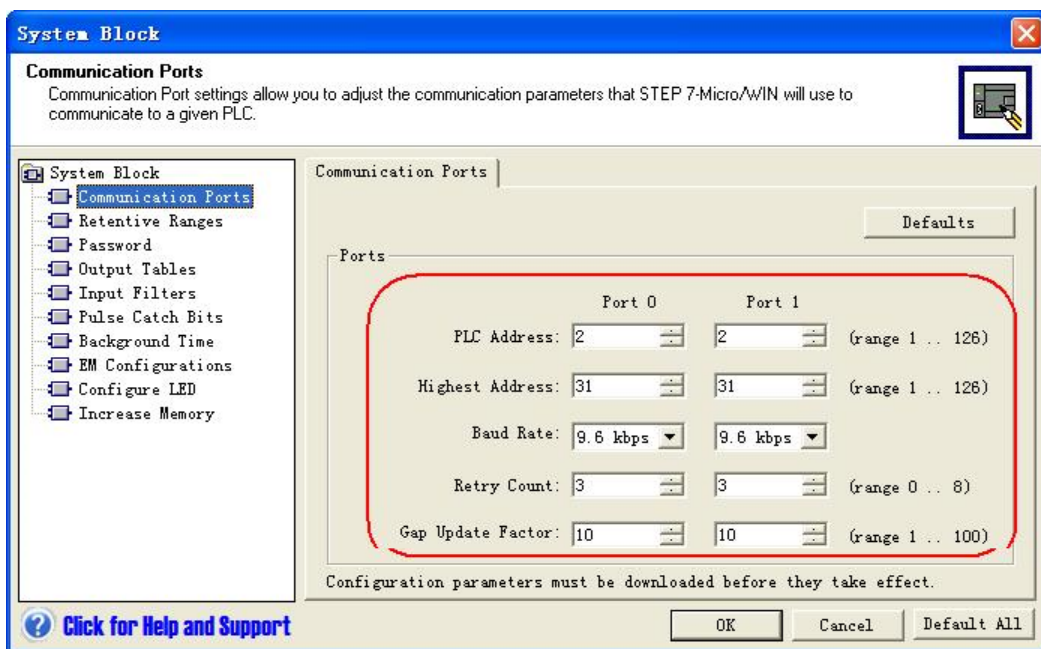

## SIEMENS S7-300/400 (PC Adapter Direct) protocol

### HMI Setting

Default communication parameters: 19200bps, 8, 2, odd; station: 2

### RS232 communication

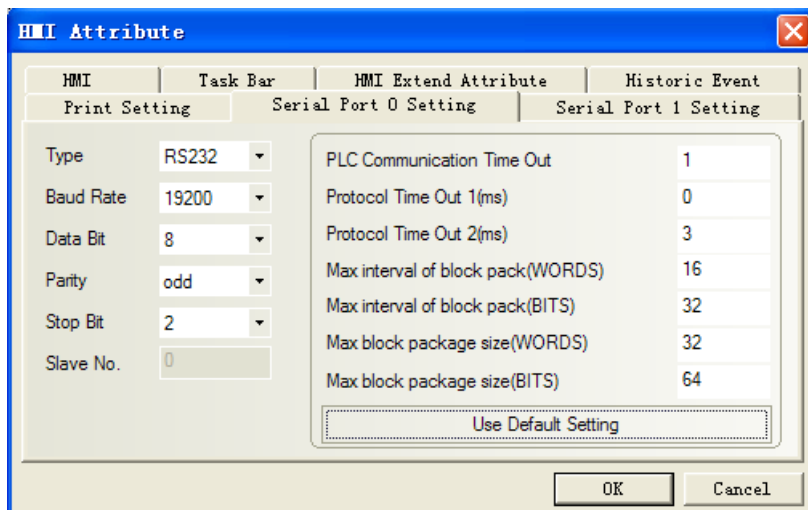

#### NOTE:

1. If you use MT5-S7-300 adapter to communicate, the baudrate of PLC must be 187.5K, and HMI must be 19.2K
2. If we use PC adapter, PLC station No. is not necessary, so the communication is one-to-one.
3. DB block must be created, otherwise the relevant registers can not write (DB.DBX, DB.DBW, DB.DBD). DBm.DBW, DBm.DBD address start must be an even number.

### PLC Setting

1. Production of the adapter with KINCO, MPI transmission rate must be set 187.5K. 19.2K general users of the transmission rate, if the S7-300 MPI-side transmission rate is 19.2K, you need to change it into the Siemens adapter 187.5K (where changes in the hardware properties)

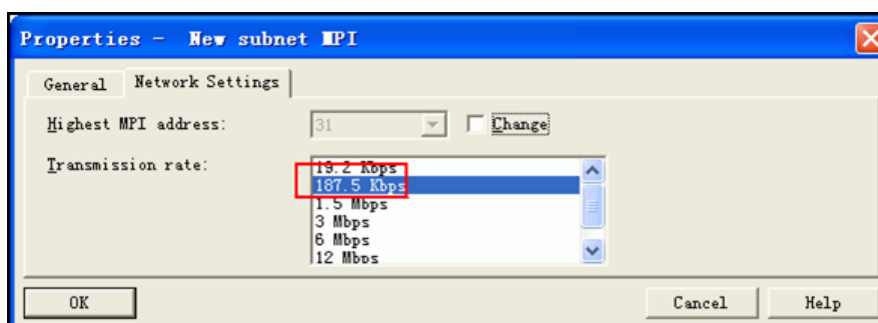

2. MPI address must be 2.

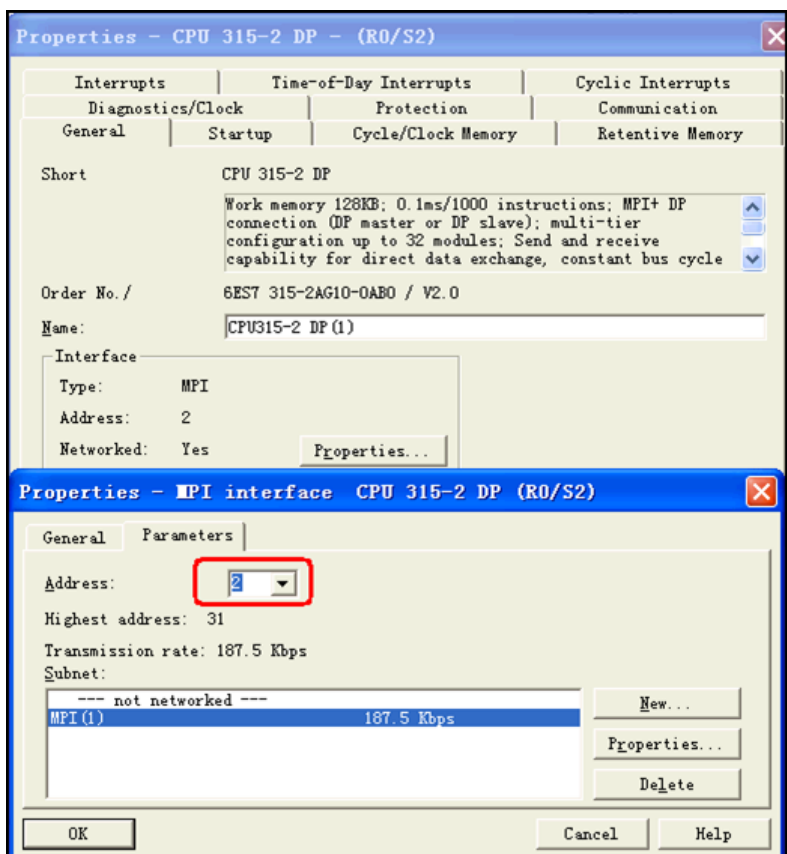

3. After the software change, downloaded to PLC, make sure the transmission rate of MPI is 187.5K, and then in the options set PG / PC interface, select PC Adapter (MPI), MPI-side of the transfer rate will be changed to 187.5K.

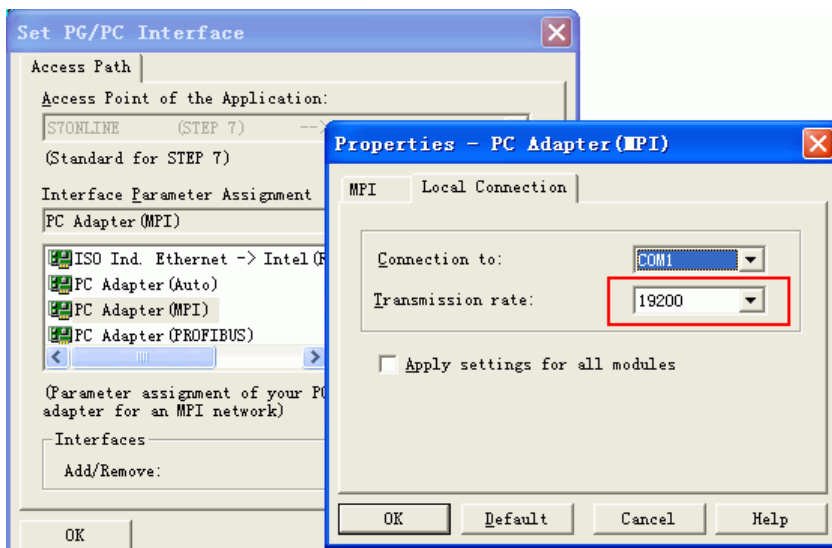



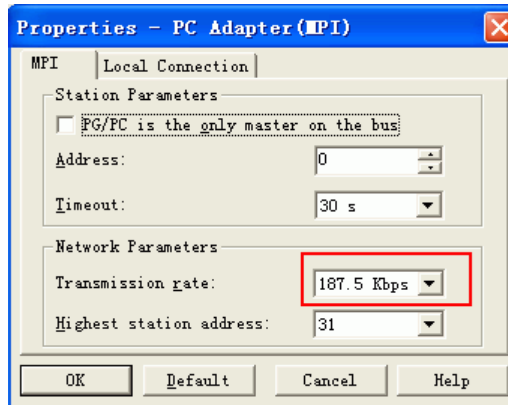

**SIEMENS S7-300/400 (MPI Direct) protocol**  
**HMI Setting**

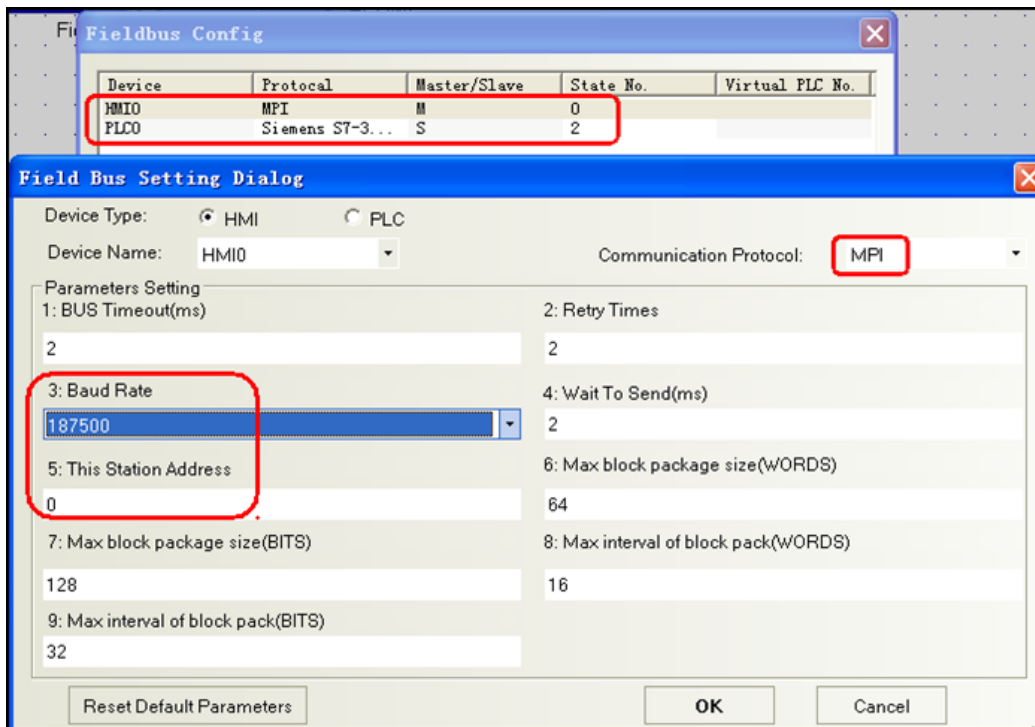
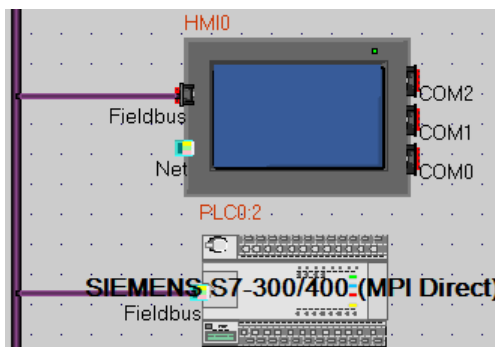

**NOTE:**

1. This protocol is suitable for MT5020 series with MPI extended port.
2. This protocol supports multi-station communication, and the MPI is RS485 port, so we can use this protocol to communicate between many HMI and PLC, and then we must set the master station number.

3. HMI station No. can be 0~15, PLC station No. must be 0~15, the station No. of HMI and PLC can not be the same number.
4. PLC baud rate can be 187.5K or 19.2K.
5. You must set DB first, or register cannot write (DB.DBX, DB.DBW, DB.DBD. The initial address of DBm.DBW and DBm.DBD must be even number.
6. This protocol doesn't support direct simulation and indirect simulation.

### PLC Setting

1. PLC station No. can be 0~15.
2. MPI baud rate can be 19.2k or 187.5k.

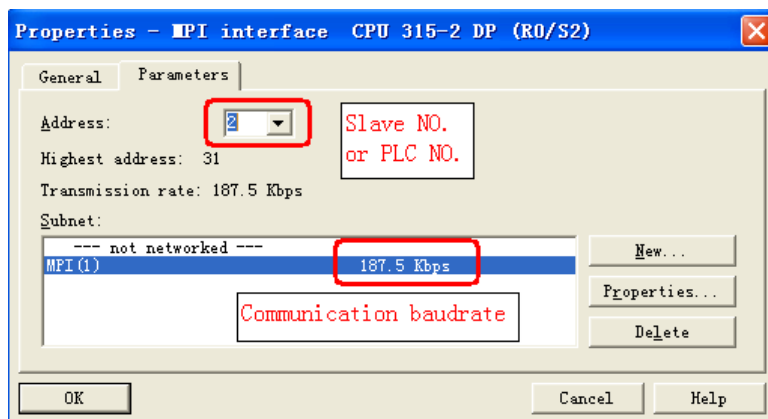

### SIEMENS MPI Direct protocol

#### HMI setting

Default parameter:19200bps, 8, none, 1; station number:2

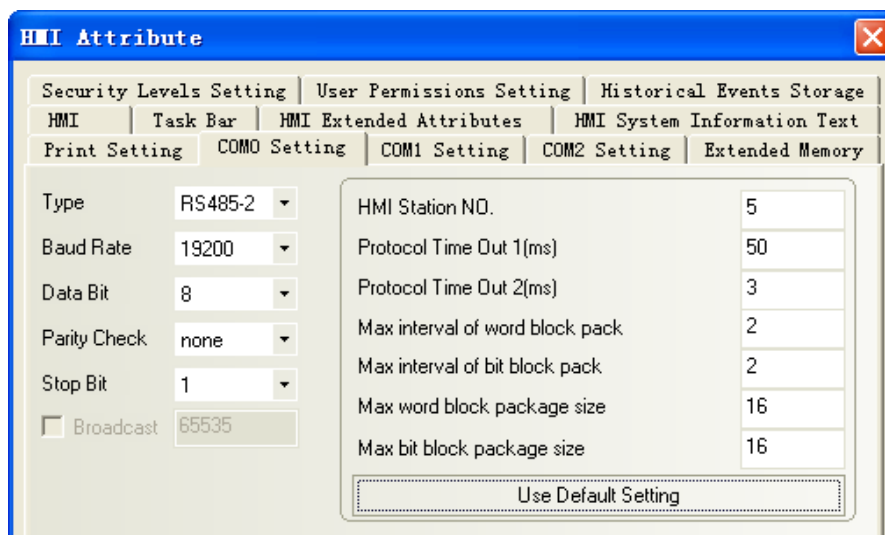

#### PLC setting

PLC station No. can be 2-15, MPI baud rate can be 19.2k or 187.5k

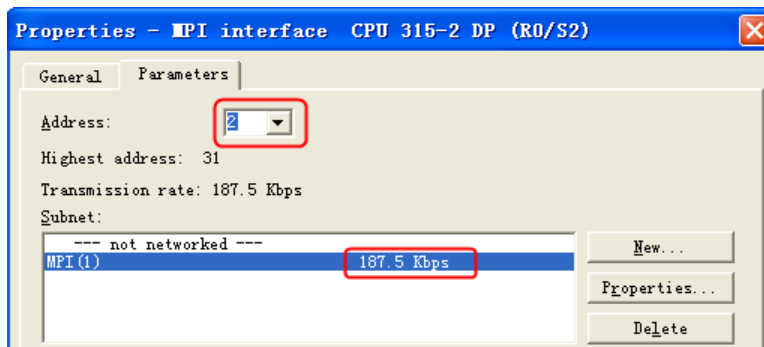
**NOTE:**

1. You should set DB block first, otherwise the registers as DB.DBX,DB.DBW and DB.DBD cannot write.
2. This protocol supports one HMI to one PLC communication

## © Ethernet Communication Setting

### SIEMENS S7-200 Ethernet (TCP Slave) protocol

#### Many(HMI)-to-One(PLC) commication

#### PLC Setting

The settings for the CP 243-1 are defined in STEP 7 Micro/WIN via the Ethernet Wizard. For assistance with all the information go to STEP 7 Micro/WIN Online Help via F1.

#### 1. Starting the Ethernet Wizard

- Open STEP 7 Micro/WIN
- Start the Ethernet Wizard via “Tools >Ethernet Wizard...”
- Click on “Next”

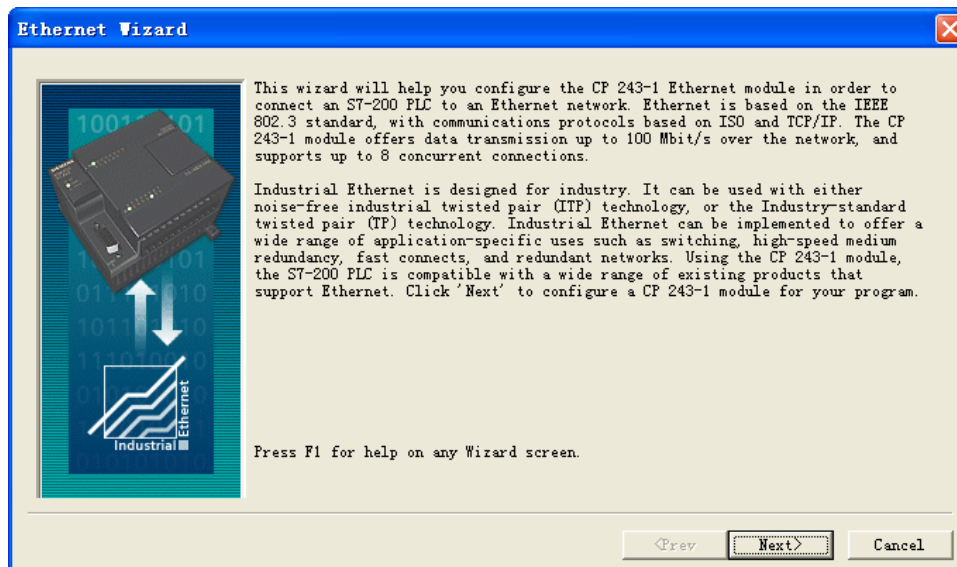

#### 2. Specifying module position

If your PC is connected to the S7-200, click the “**Read modules**” button to determine the position of the CP 243-1 module automatically. Otherwise, the module position can also be entered manually.

Important:

The panel can only establish a connection with a Cp243-1 if the module is configured to “position 0”.

- Check if the CP is connected in the module position “ZERO” and change the module position if necessary.
- Identify or enter the module position “ZERO”.
- Click on “Next”.

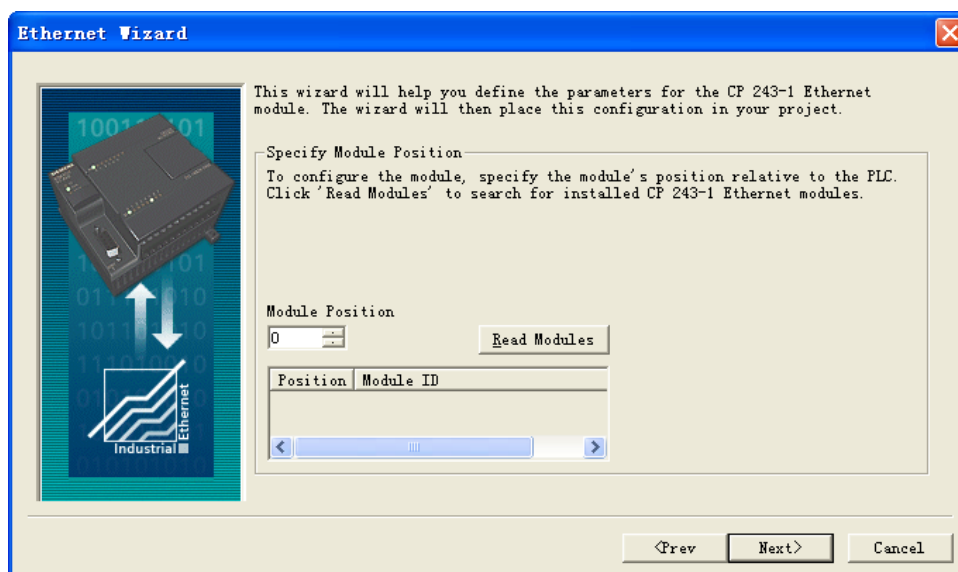

3.0 Define an IP address for the CP 243-1.

**Caution:**The IP address for this application may not be taken automatically from a server because the panel requires a fixed reference partner (CP 243-1) for the Ethernet communication.

**Note:** The communication connection type for this module can be defined by the “Automatic Setting”.

4.0 Click on “Next” to continue.

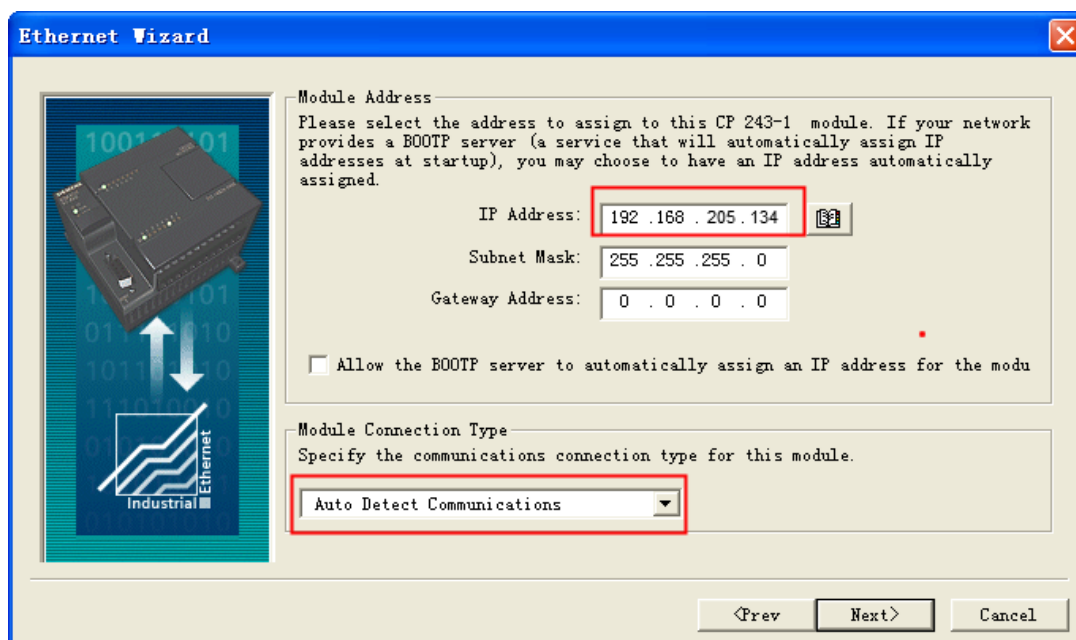

5.0 Specify the command byte for the module and the number of point-to-point connections with the CP 243-1.

6.0 Click on “Next”

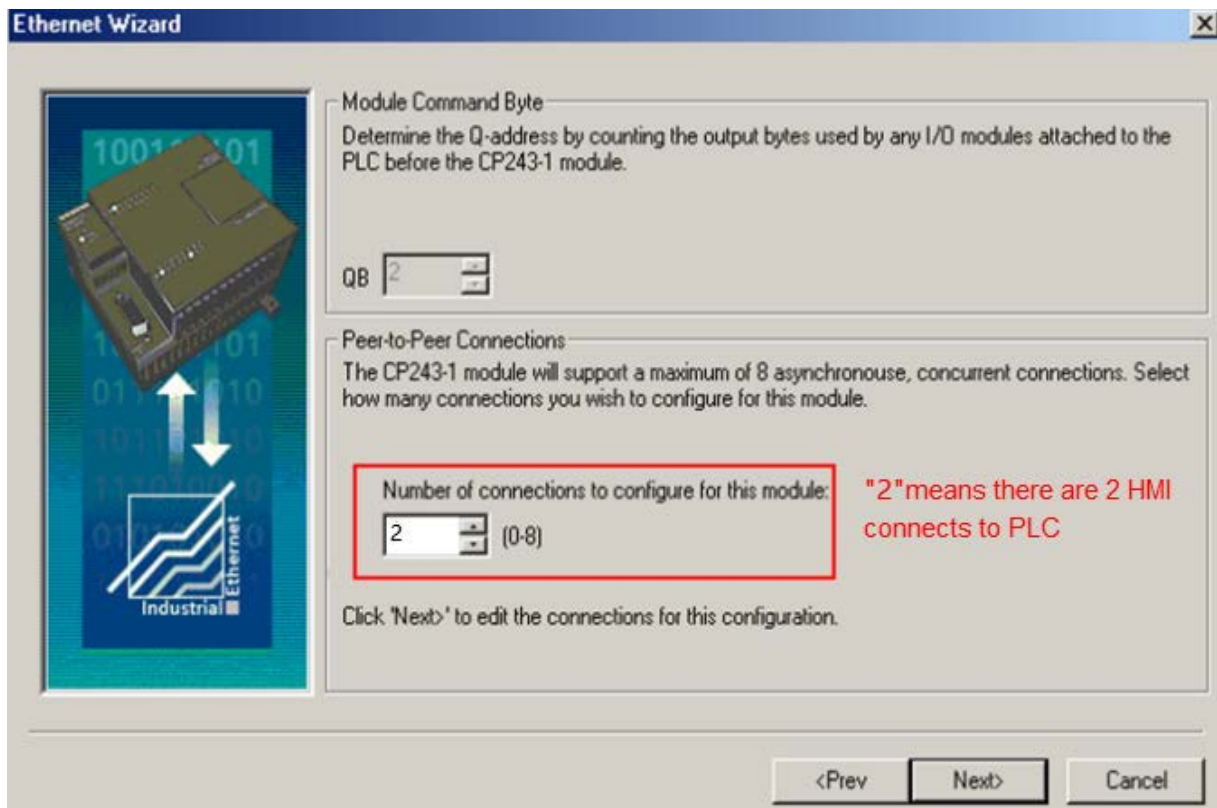

## 5. Configuration connection

7.0 The configuration for connecting the CP 243-1 to the panel is defined as in Fig..

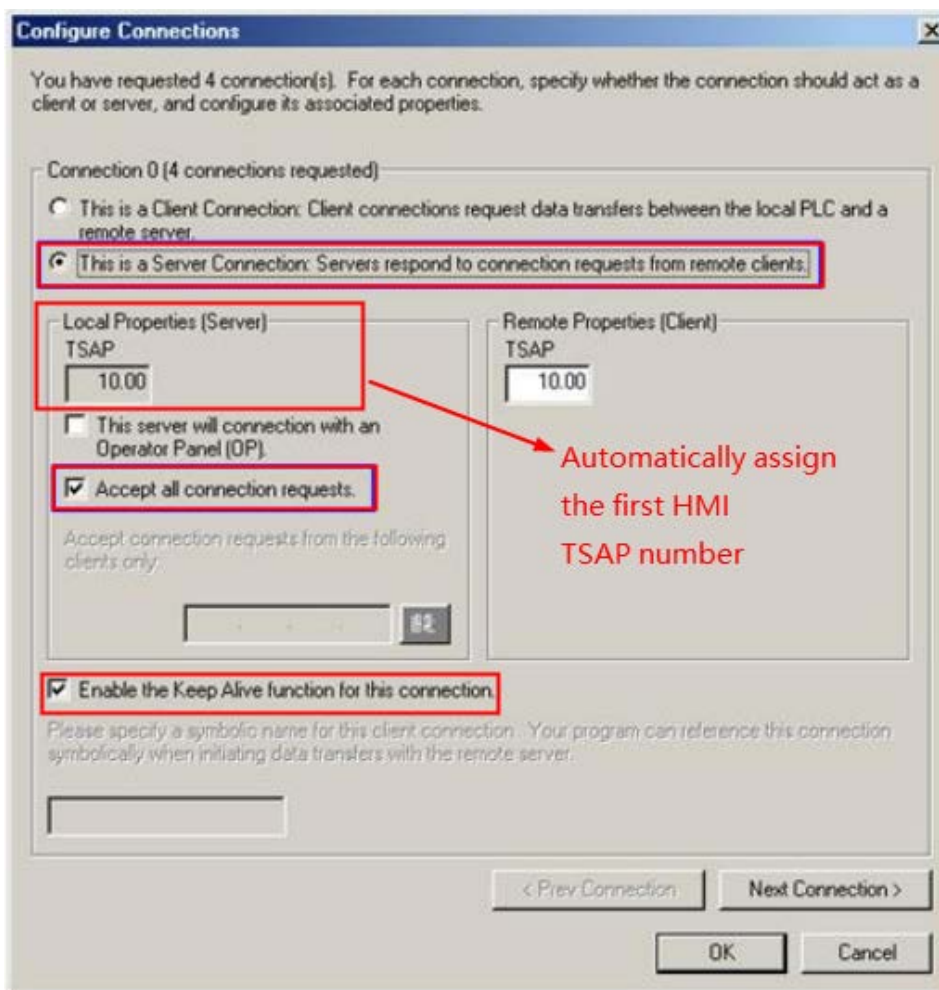

Click "Next Connection"

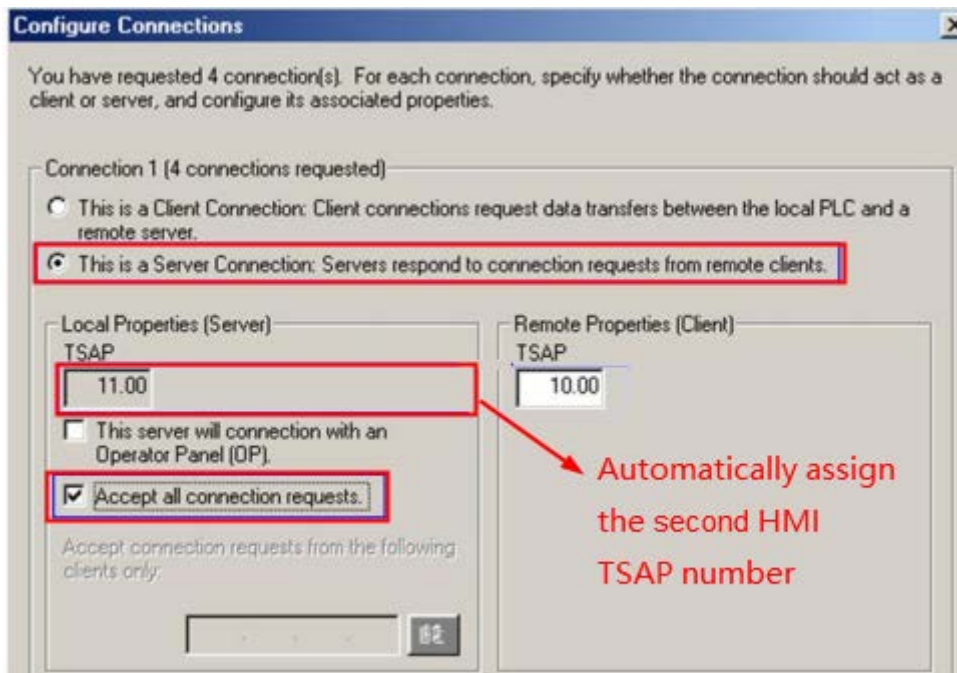

### 6. Using CRC protection

Set the CRC protection the way you want it. It is advisable to work without CRC protection first of all. The

“Keep Alive Interval” can be specified with the default time.

8.0 Activate the CRC protection and change the time of the “Keep Alive Interval” if required.

9.0 Click on “Next”.

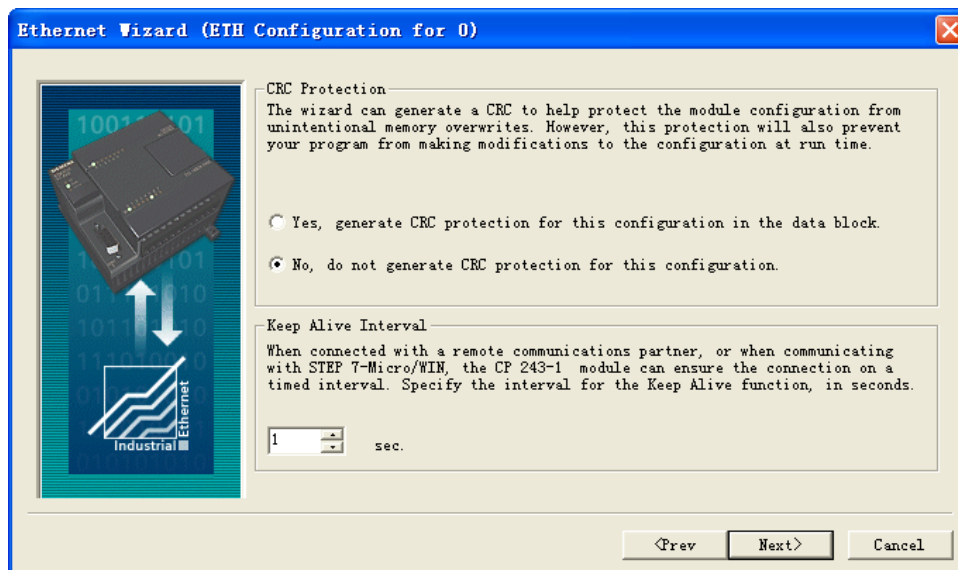

## 7. Assigning memory

10.0 Specify a memory area for the configuration of the CP 243-1.

Recommend: If you click on **Suggest address**, the Wizard can identify a variable memory area.

Note: The register used in the panel must be out of the memory area for the configuration.

11.0 Click on “Next”.

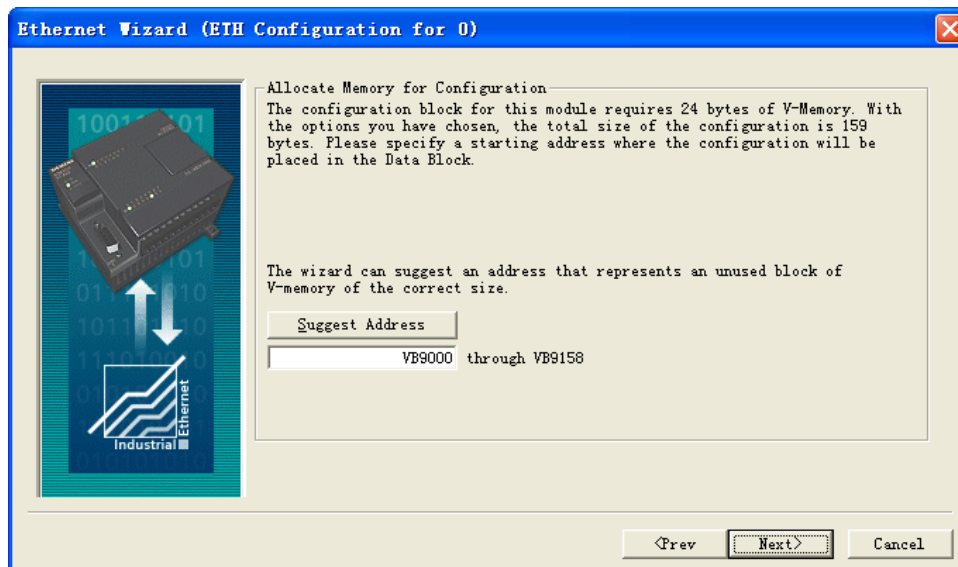

## 8. Creating project components

If you click on “Close”, the Ethernet Wizard generates the project components for the set configuration.

Among other things, subprograms and the variable memory are created in the data block.

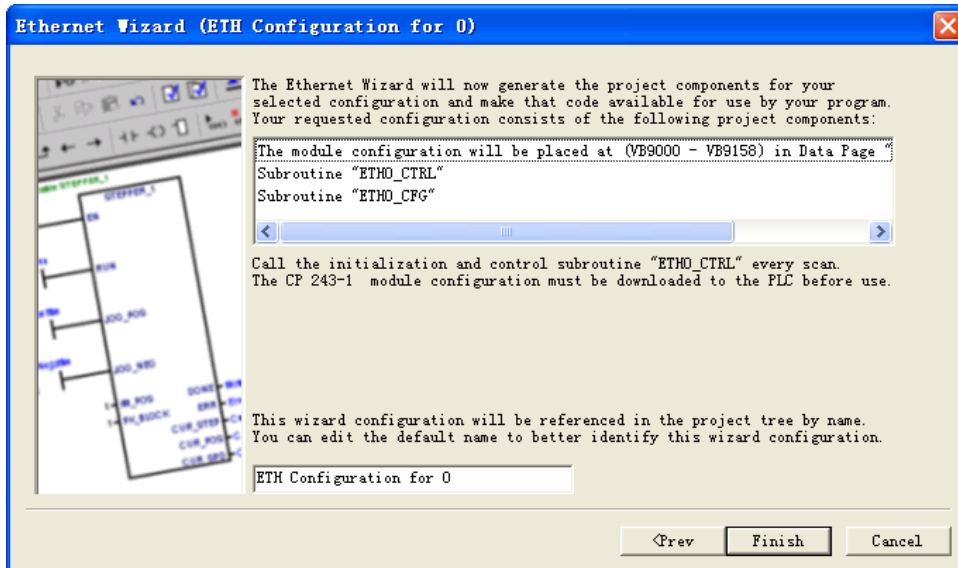

**9. Confirm message**

12.0 Click "Yes" to confirm the message that appears.



**10. Call ETHO\_CTRL**

13.0 In your STEP 7 Micro/WIN program, you must call the ETHO\_CTRL subroutine in each cycle.

14.0 Finally, load the entire configuration into the S7-200.

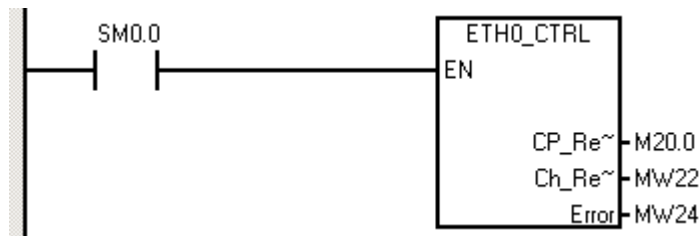

**HMI Setting**

Take the second HMI connection as an example

Device	IP Addr	Port	Protocol	Master/..
HMI0	192.168.205.163	102	SIEMENS S7-200 Ethernet(TCP)	M
PLC_0_1	192.168.205.134	102	SIEMENS S7-200 Ethernet (TCP Slave)	S



**Note:** The TSAP set in the PLC software needs to be filled in the protocol timeout here and converted into decimal, as shown in the figure.

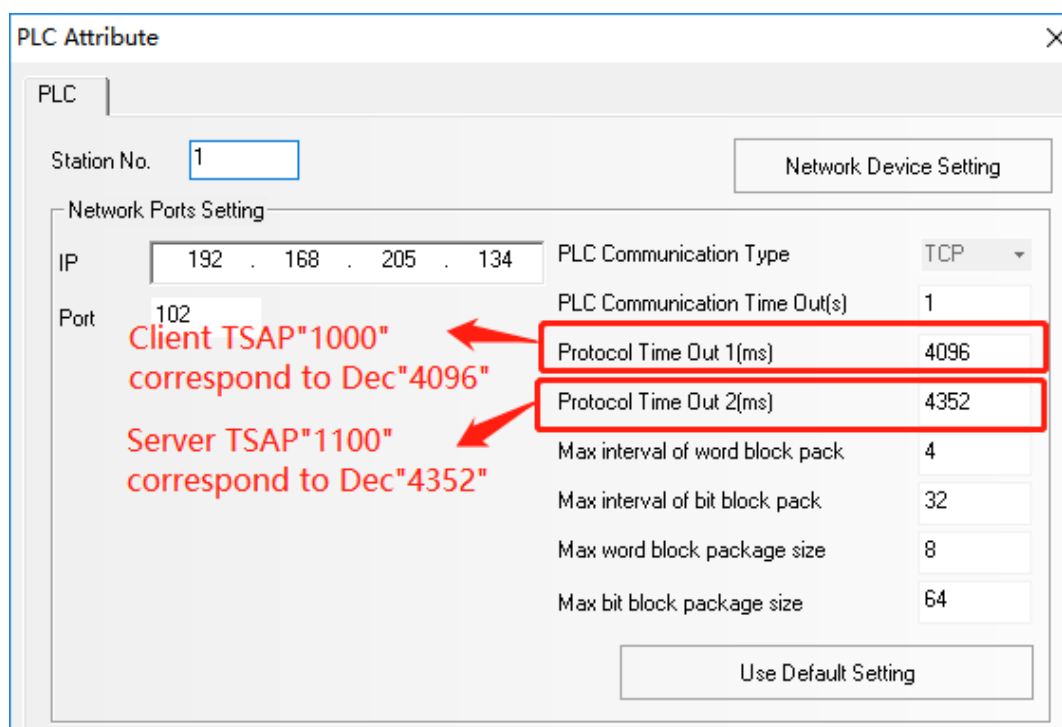
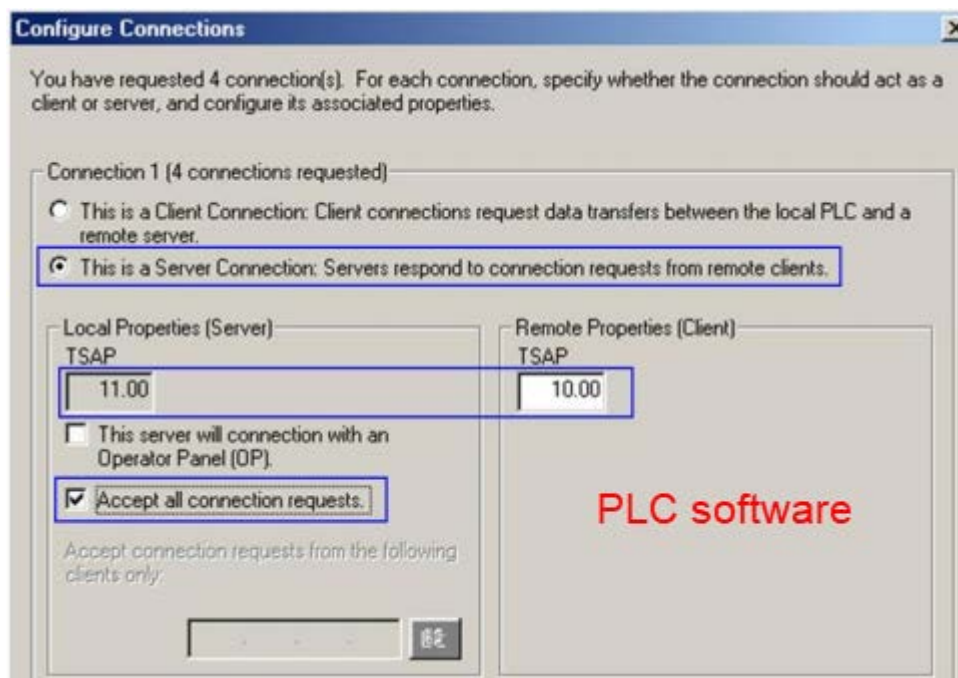

### One-to-One communication

Other settings are consistent with many-to-one communication, but the number of connections and TSAP setting are different, as shown in the figure.

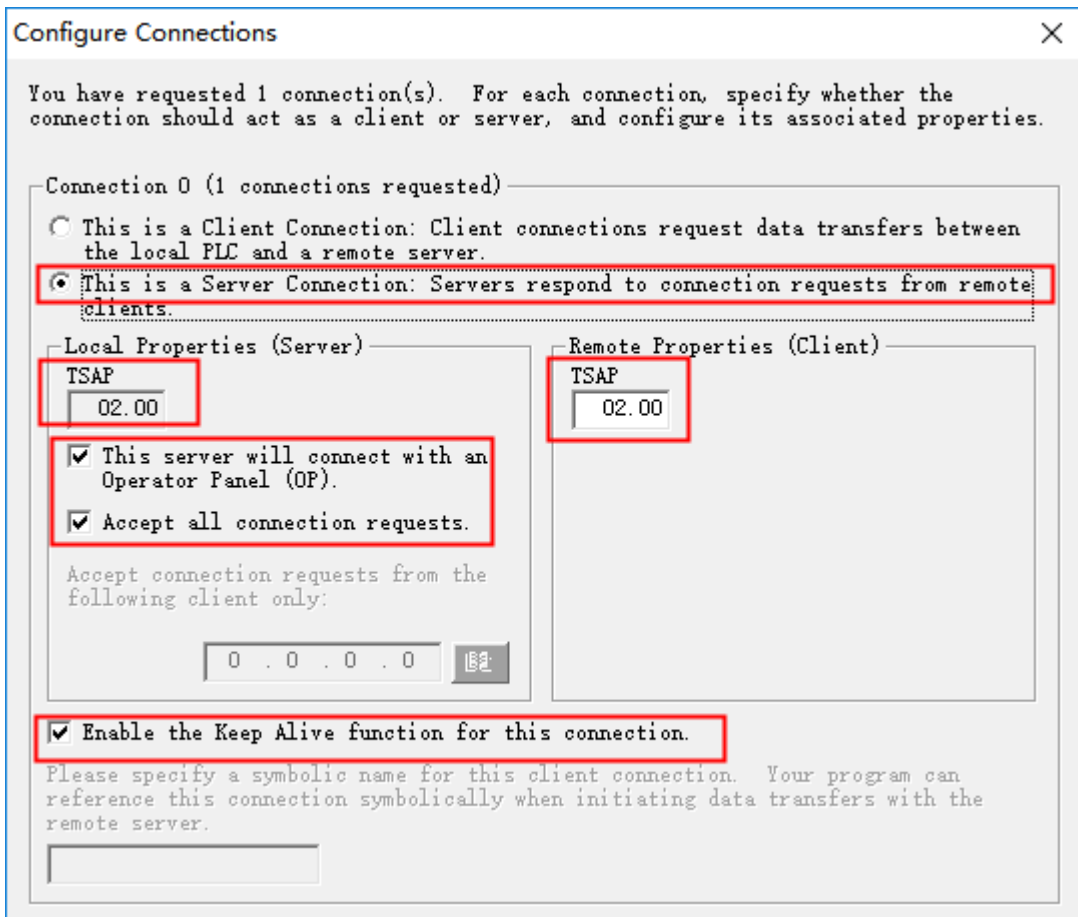
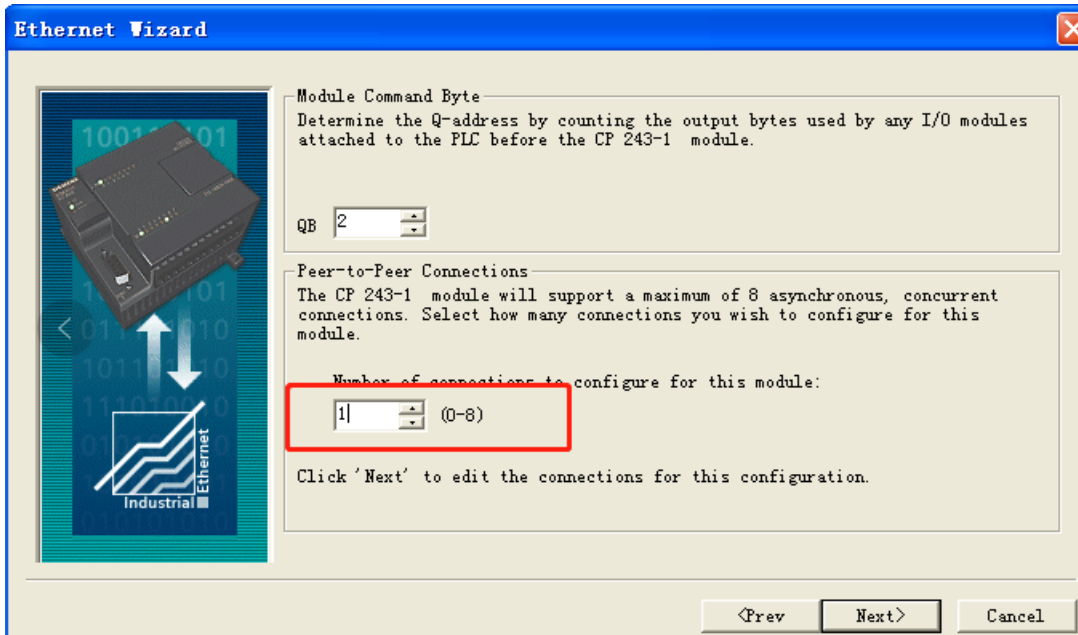

**Warning:** The TSAP must always be specified in four-digit format, with a leading zero (02.00).

### HMI Setting

**Network Device Setting**

Device	IP Addr	Port	Protocol	Master/...
HMI0	192.168.205.163	102	SIEMENS S7-200 Ethernet(TCP)	M
PLC_0_1	192.168.205.134	102	SIEMENS S7-200 Ethernet (TCP Slave)	S

PLC Attribute

Station No. 1

Network Device Setting

Network Ports Setting

IP: 192 . 168 . 205 . 134

Port: 102

PLC Communication Type: TCP

PLC Communication Time Out(s): 1

Protocol Time Out 1(ms): 1

Protocol Time Out 2(ms): 0

Max interval of word block pack: 4

Max interval of bit block pack: 32

Max word block package size: 8

Max bit block package size: 64

Use Default Setting

**SIEMENS S7-200 SMART Ethernet (TCP Slave) protocol**  
**HMI Setting**

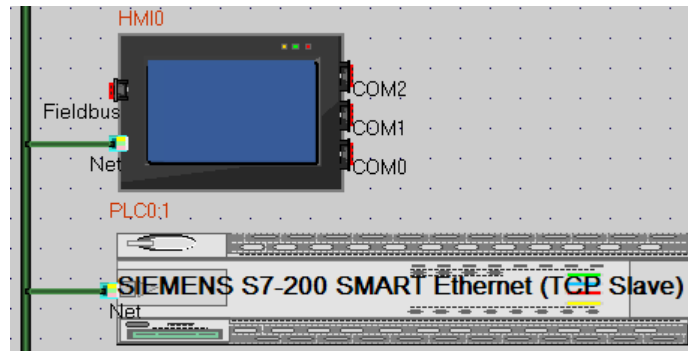

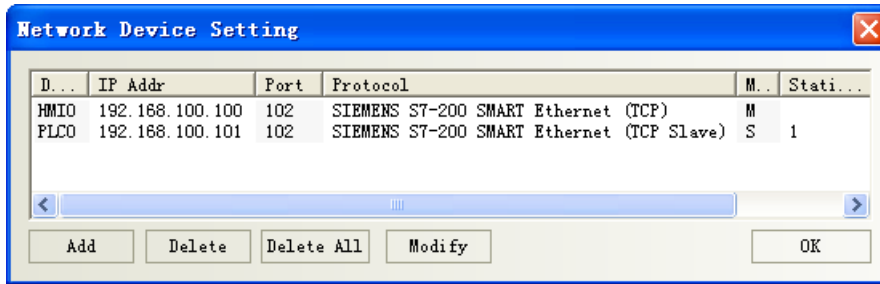

## SIEMENS S7-1200 Ethernet(TCP Slave) protocol

### HMI Setting

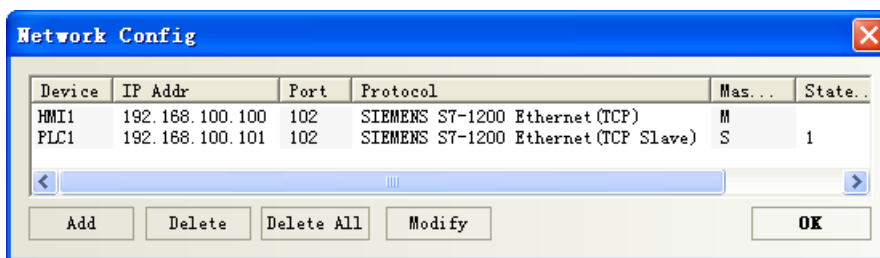
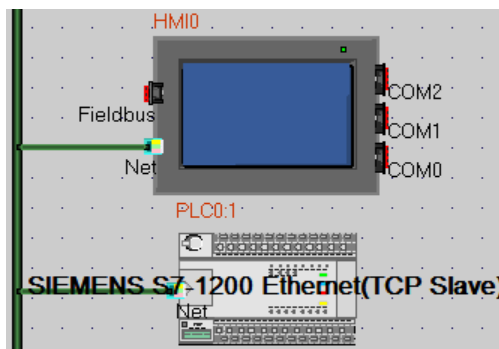

### PLC Setting

#### 1. Modify the IP address

a. Setting IP in "General" → "Profinet interface"

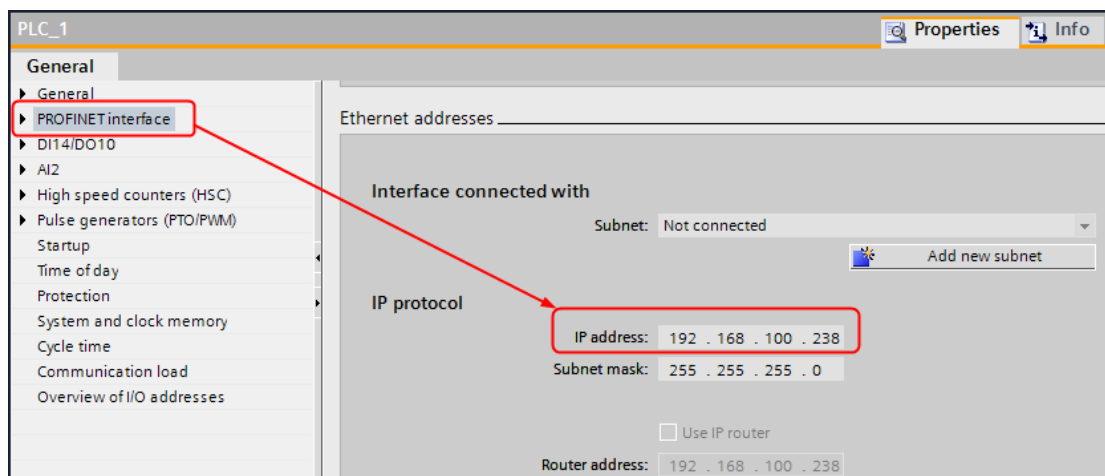

b. After configuration, download device. Download in the first time, select the "Extended download to device", in the dialog to select show all accessible devices.

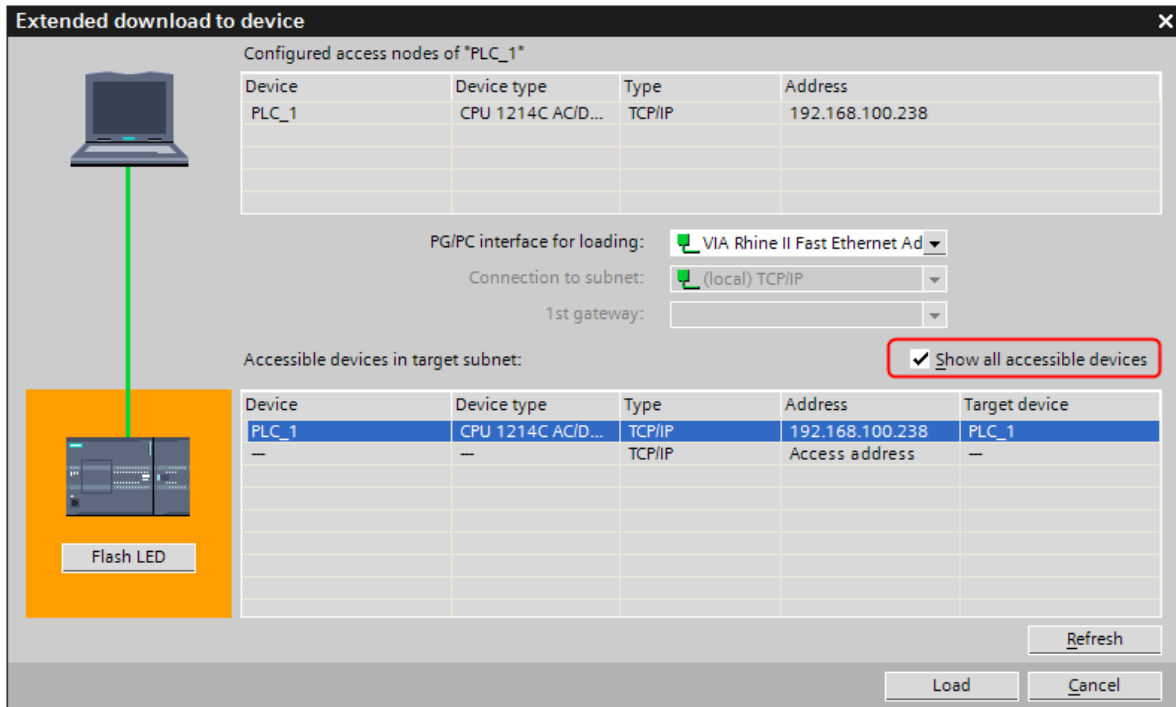

c. Select the device, press "Load".

## 2. Build the data block

### Portal10:

Data block must be created, otherwise the relevant registers can not write (DB.DBX, DB.DBW, DB.DBD).

Double-click "Add new block"

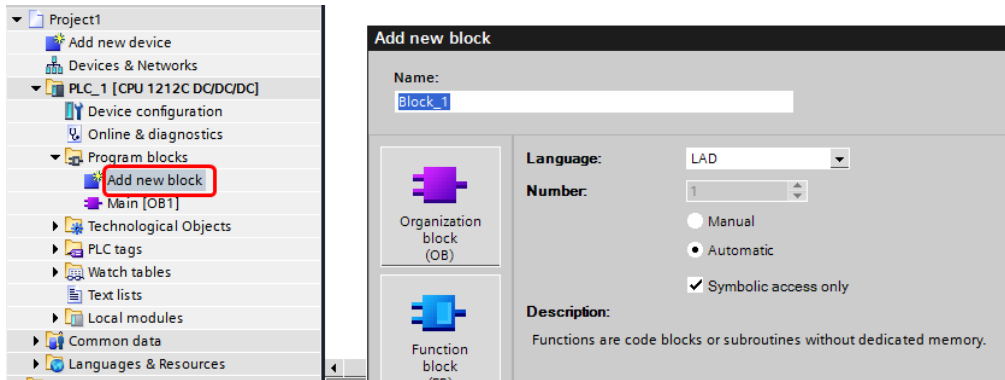

For example, add new block "DB10", setting as follow

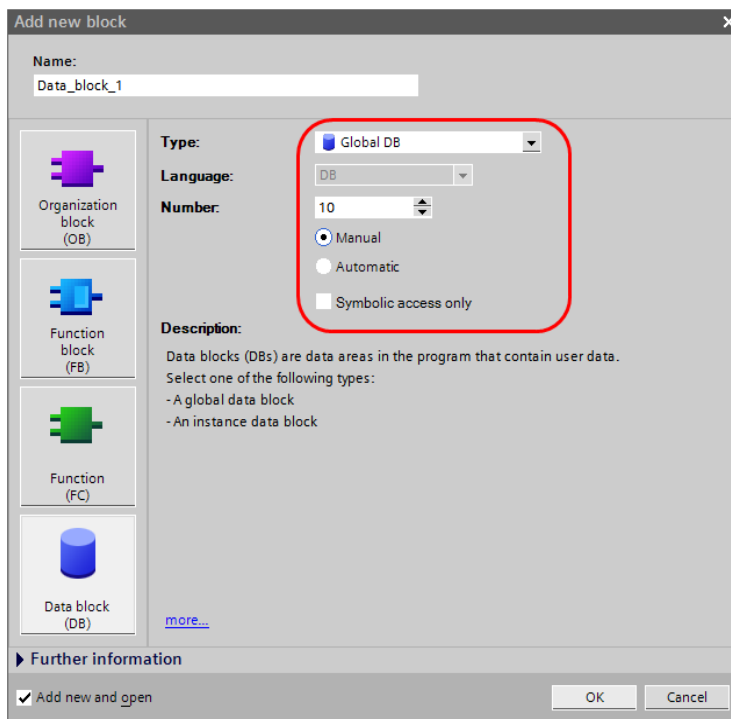
**NOTE:**

1. Make sure the data type of PLC same as the HMI when defining the data block. For example, if the data type of PLC is REAL, then the data type of number input/display component must be float in HMI.
2. Make sure that the data block defined in PLC should be more than the data block used in HMI. For example, if DB5.DBW32 is used in HMI, user can't define the data block up to DB5.DBW32, but up to DB5.DBW34 or more.

**Portal13:**

1. Must disable "Optimized block access" in the DB block properties-[general]-[Attributes].



2. Must enable "Permit access with PUT/GET communication from remote partner (PLC, HMI, OPC, ...)" in the CPU properties-[General]-[Protection].

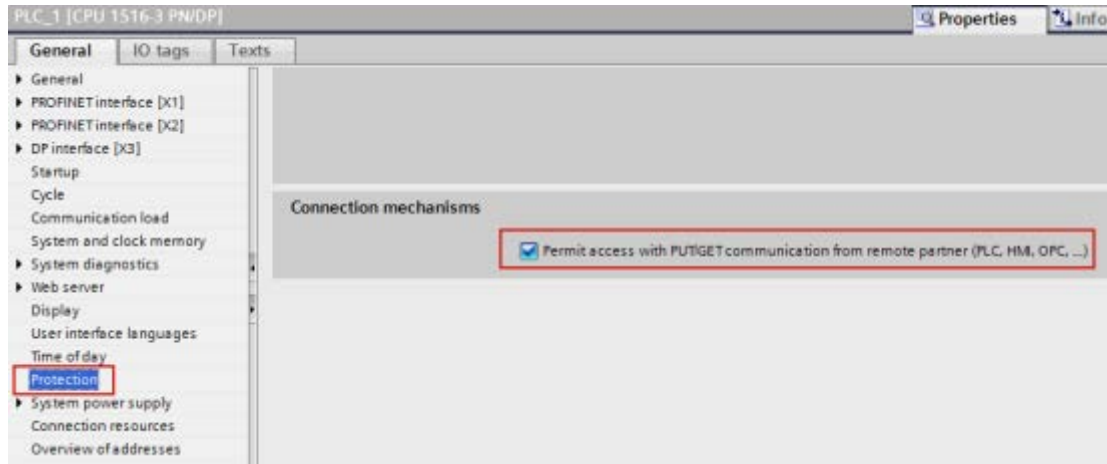

## SIEMENS S7-300 Ethernet(TCP Slave) protocol HMI Setting

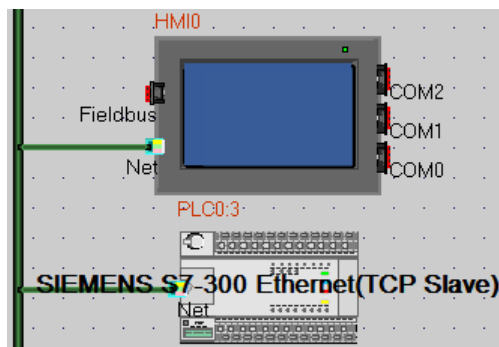

Device	IP Addr	Port	Protocol	Mast...	Sta
HMI1	192.168.100.100	102	SIEMENS S7-300 Ethernet(TCP)	M	
PLC1	192.168.100.101	102	SIEMENS S7-300 Ethernet(TCP Slave)	S	1

Buttons: Add, Delete, Delete All, Modify, OK

## PLC Setting

1. In "HW configuration" insert CP300 industrial Ethernet.

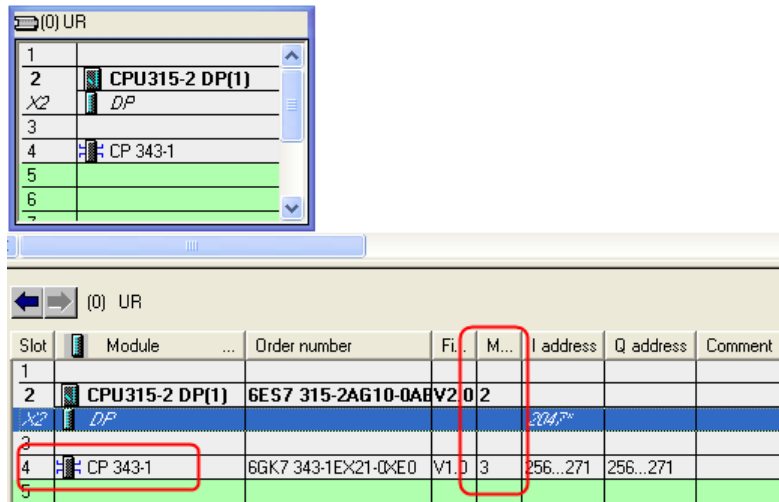

2. Set IP address in the Properties of CP343-1.

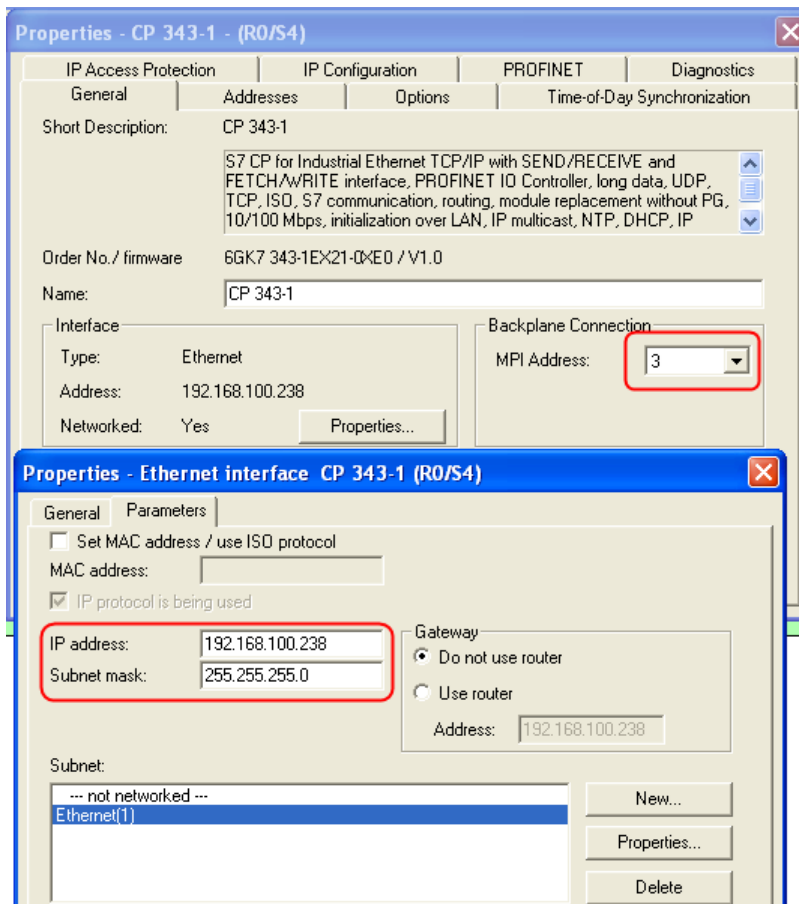

3. After HW configuration, download.

## SIEMENS S7-400 Ethernet(TCP Slave) protocol HMI Setting



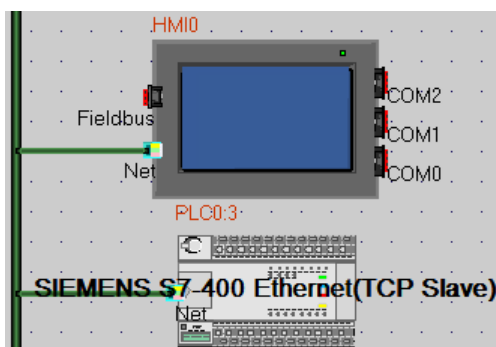

**Network Config**

Device	IP Addr	Port	Protocol	Mast...	State
HMI1	192.168.100.100	102	SIEMENS S7-400 Ethernet(TCP)	M	
PLC1	192.168.100.101	102	SIEMENS S7-400 Ethernet(TCP Slave)	S	3

Buttons: Add, Delete, Delete All, Modify, OK

**PLC Attribute**

Station No.

Network Device Setting

Network Ports Setting

IP  PLC Communication Type

Port  PLC Communication Time Out(s)

Protocol Time Out 1(ms)  **IP address of Redundant PLC**

Protocol Time Out 2(ms)

Max interval  **IP address of current PLC**

Max interval or bit block pack

Max word block package size

Max bit block package size

Use Default Setting

Buttons: OK, Cancel

**NOTE:** Dual redundant parameters configuration of S7-400 Ethernet communication

15.0 The station No. is composed of two parts: track No. and slot No., and station No. is a byte, the track No. is the high 4 bits, and the slot No. is the low 4 bits. For example, the station No. is 0x03 in hex, that is to say, the track No. is 0 and CPU slot No. is 3.

16.0 Protocol timeout 1 stands for IP address of redundancy PLC. For example, if the IP address is 192.168.100.240, corresponding to the hex value 0xC0A864F8, then transfer this value to decimal, it is 3232261368.

17.0 Protocol timeout 2 stands for track No. and Slot No. of redundant PLC, for example, if the Protocol timeout 2 is 19, corresponding to the 0x13 in hex, that is to say the track No. is 1 and slot No. is 3.

18.0 When configuring PLC in HMI program, just need to configure one PLC but not two.

## PLC Setting

1. In the hardware configuration, insert CP400 Ethernet module CP443-1:

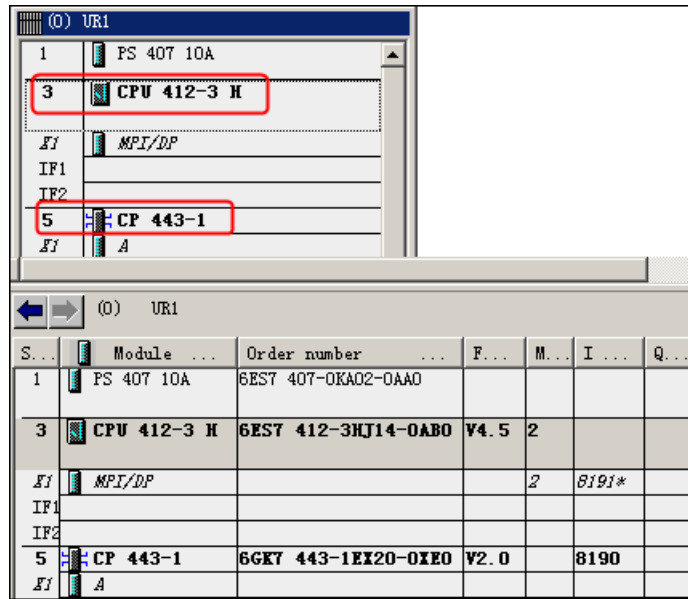

2. Open the Properties of CP443-1, set the IP address. No need to set MAC address.

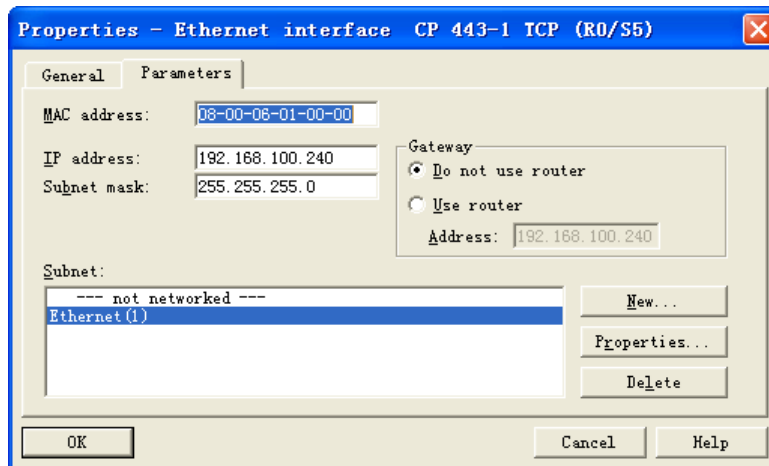

3. Download after finishing hardware configuration

## SIEMENS LOGO! Ethernet(TCP Slave)

### HMI Setting



Device	IP Addr	Port	Protocol	Master/.	Stati.	Virtual..
HMI0	192.168.1.100	102	SIEMENS...	M		
PLC0	192.168.1.40	102	SIEMENS...	S	1	

## PLC Setting

Set the same parameters as the HMI dose.

### ◎Supported Device

#### S7-200

Device	Bit Address	Word Address	Format
SCR	S.B 0.0-31.7	-----	DDD.O
Special memory Relay	SM.B 0.0-1535.7	-----	DDDD.O
Counter Relay	Cnt 0-255	-----	DDD.O
Timer Relay	Tim 0-255	-----	DDD.O
V Relay	V.B 0.0-20479.7	-----	DDDDD.O
Internal Memory Relay	M.B 0.0-31.7	-----	DDDDD.O
Discrete outputs and image Relay	Q.B 0.0-15.7	-----	DDDDD.O
Discrete inputs and image Relay	I.B 0.0-15.7	-----	DDDDD.O
Analog Outputs	-----	AQW 0-110	DD
Analog Inputs	-----	AIW 0-110	DD
SCR double word	-----	SD 0-28	DD
SCR	-----	SW 0-30	DD
Special memory double word	-----	SMD 0-1532	DDD
Special memory	-----	SMW 0-1534	DDD
Internal memory double word	-----	MD 0-28	DD
Internal memory	-----	MW 0-30	DD
Discrete outputs and image register double word	-----	QD 0-28	DD
Discrete outputs and image register	-----	QW 0-30	DD
Discrete inputs and image register double word	-----	ID 0-28	DD
Discrete inputs and image register	-----	IW 0-30	DD
Timer (Current Value)	-----	Cnt 0-255	DDD
Counter (Current Value)	-----	Tim 0-255	DDD
V memory double word	-----	VD 0-20478	DDDDD
V memory	-----	VW 0-20476	DDDDD
V memory	-----	VB 0-20476	DDDDD
Internal memory	-----	MB 0-30	DD

**NOTE:** VW、VD address must be an even number

#### SIEMENS S7-200 Ethernet(TCP Slave)

Device	Bit Address	Word Address	Format	Notes
V Relay	V.B 0.0-20479.7	-----	DDDD.O	
Internal Memory Relay	M.B 0.0-31.7	-----	DD.O	

Discrete outputs and image Relay	Q.B 0.0-31.7	-----	DD.O	
Discrete inputs and image Relay	I.B 0.0-31.7	-----	DD.O	
Special memory Relay	SM.B 0.0-1535.7	-----	DDDD.O	
SCR	S.B 0.0-31.7	-----	DD.O	
	T.FLAG 0-255	-----	DDD	
	C.FLAG 0-255	-----	DDD	
Internal memory double word	-----	MD 0-28	DD	
Internal memory	-----	MW 0-30	DD	
Discrete outputs and image register double word	-----	QD 0-28	DD	
Discrete outputs and image register	-----	QW 0-30	DD	
Discrete inputs and image register double word	-----	ID 0-28	DD	
Discrete inputs and image register	-----	IW 0-30	DD	
V memory double word	-----	VD 0-20478	DDDD	
V memory	-----	VW 0-20476	DDDD	
	-----	SMW 0-1534	DDDD	
	-----	SW 0-30	DD	
	-----	TW 0-255	DDD	
	-----	CW 0-255	DDD	
	-----	AIW 0-110	DDD	
	-----	AQW 0-110	DDD	
	-----	VB 0-20476	DDD	
	-----	MB 0-31	DD	

#### SIEMENS S7-200 SMART Ethernet(TCP Slave)

Device	Bit Address	Word Address	Format	Notes
V Relay	V.B 0.0-20479.7	-----	DDDD.O	
Internal Memory Relay	M.B 0.0-31.7	-----	DD.O	
Discrete outputs and image Relay	Q.B 0.0-31.7	-----	DD.O	
Discrete inputs and image Relay	I.B 0.0-31.7	-----	DD.O	
Special memory Relay	SM.B 0.0-1535.7	-----	DDDD.O	
SCR	S.B 0.0-31.7	-----	DD.O	
Internal memory double word	C.FLAG 0-255	-----	DDD	
Internal memory	T.FLAG 0-255	-----	DDD	
Discrete outputs and image register double word	-----	MD 0-28	DD	
Discrete outputs and image register	-----	MW 0-30	DD	

Discrete inputs and image register double word	-----	QD 0-28	DD	
Discrete inputs and image register	-----	QW 0-30	DD	
V memory double word	-----	ID 0-28	DD	
V memory	-----	IW 0-30	DD	
V Relay	-----	Cnt 0-255	DDD	
Internal Memory Relay	-----	Tim 0-255	DDD	
Discrete outputs and image Relay	-----	VD 0-20478	DDDD	
Discrete inputs and image Relay	-----	VW 0-20476	DDDD	
	-----	SMW 0-1534	DDDD	
	-----	SW 0-30	DD	
	-----	T 0-255	DDD	
	-----	C 0-255	DDD	
	-----	AIW 0-110	DDD	
	-----	AQW 0-110	DDD	
	-----	VB 0-20476	DDD	
	-----	MB 0-31	DD	

#### SIEMENS S7-300/400 (PC Adapter Direct)

Device	Bit Address	Word Address	Format	Notes
External Input node	I 0.0~511.7	-----	DDDD.O	
External Output node	Q 0.0~511.7	-----	DDDD.O	
Internal assistant node	M 0.0~4095.7	-----	DDDD.O	
Data Register Relay node	DBm.DBX 0~65535.7	-----	DDDDD.O	m:10~60
Data Register Relay	-----	DBm.DBW 0-65534	DDDDD	m:10~60
Data Register Relay (32 bit)	-----	DBm.DBD 0-65532	DDDDD	m:10~60
Internal Relay	-----	MW 0~9999	DDDD	
Internal Relay (32 bit)	-----	MD 0~9999	DDDD	
External Output Relay	-----	QW 0~9999	DDD	
External Output Relay (32 bit)	-----	QD 0~9999	DDD	
External Input Relay	-----	IW 0~9999	DDD	
External Input Relay (32 bit)	-----	ID 0~9999	DDD	

#### NOTE:

1. The initial address of DBm.DBW and DBm.DBD must be even number.
2. Make sure that the data block defined in PLC should be more than the data block used in HMI. For example, if DB5.DBW32 is used in HMI, user can't define the data block up to DB5.DBW32, but up to DB5.DBW34 or more.

#### SIEMENS S7-300/400 (MPI Direct)& SIEMENS MPI

Device	Bit Address	Word Address	Format	Notes
External Input node	I 0.0~255.7	-----	DDDD.O	
External Output node	Q 0.0~255.7	-----	DDDD.O	
Internal assistant node	M 0.0~8191.7	-----	DDDD.O	
Data Register Relay node	DBm.DBX 0.0~65533.7	-----	DDDDD.O	m:1~60
Data Register Relay node	DBn.DBX 100000.0~409665535.7	-----	DDDDD.O	n:1~4096
Counter	-----	C 0~2047	DDD	*1
Timer	-----	T 0~2047	DDD	
Internal Relay	-----	MW 0~8190	DDDD	
External Output Relay	-----	QW 0~254	DDD	
External Input Relay	-----	IW 0~254	DDD	
Internal Relay	-----	MD 0~8188	DDDD	
External Output Relay	-----	QD 0~252	DDD	
External Input Relay	-----	ID 0~252	DDD	
Data Register Relay	-----	DBm.DBW 0~65532	DDDDD	m:1~60
Data Register Relay (32 bit)	-----	DBm.DBD 0~65532	DDDDD	m:1~60
Data Register Relay	-----	DBn_DBW 100000-409665534	DDDDDDDD	n:1~4096
Data Register Relay (32 bit)	-----	DBn_DBD 100000-409665532	DDDDDDDD	n:1~4096

**NOTE:**

1. DBn\_DBX, DBn\_DBW, DBn\_DBD is a custom block. First four data formats for data block number, the address after the five, less than five former address zeros. To DB20.DBX23.4 example, EV5000 software addresses to DBn\_DBX: 2000023.4
2. The initial address of DBm.DBW, DBm.DBD must be an even number.
3. \*1 T/C registers are read only.
4. Make sure that the data block defined in PLC should be more than the data block used in HMI. For example, if DB5.DBW32 is used in HMI, user can't define the data block up to DB5.DBW32, but up to DB5.DBW34 or more.

**SIEMENS S7-1200 Ethernet(TCP Slave)**

Device	Bit Address	Word Address	Format	Notes
External Input node	I 0.0~127.7	-----	DDDD.O	
External Output node	Q 0.0~127.7	-----	DDDD.O	
Internal assistant node	M 0.0~2047.7	-----	DDDD.O	
Data Register Relay node	DBn_DBX 100000.0~25565535. 7	-----	DDDDDDDD.O	

Data Register Relay node	DBm_DBX 0.0~65535.7	-----	DDDDD.O	m:1~10
Data Register Relay	-----	DBn_DBW 100000-2556553 4	DDDDDDDD	n:1~255
Data Register Relay (32 bit)	-----	DBn_DBD 100000-2556553 2	DDDDDDDD	n:1~255
Data Register Relay	-----	DBm_DBW 0-65534	DDDDD	m:1~10
Data Register Relay (32 bit)	-----	DBm_DBD 0-65532	DDDDD	
Internal Relay	-----	MW 0~8190	DDDD	
Internal Relay (32 bit)	-----	MD 0~8188	DDDD	
External Output Relay	-----	QW 0~1022	DDD	
External Output Relay (32 bit)	-----	QD 0~1020	DDD	
External Input Relay	-----	IW 0~1022	DDD	
External Input Relay (32 bit)	-----	ID 0~1020	DDD	

**NOTE:**

1. EV5000 in the DB register corresponds to the definition of S7-1200 software, the absolute address of DB, rather than the global symbol DB.
2. DBn\_DBX, DBn\_DBW, DBn\_DBD is a custom block. First three data formats for data block number, the address after the five, less than five former address zeros. To DB20.DBX23.4 example, EV5000 software addresses to DBn\_DBX: 2000023.4
3. The initial address of DBm.DBW, DBm.DBD must be an even number.
4. Make sure that the data block defined in PLC should be more than the data block used in HMI. For example, if DB5.DBW32 is used in HMI, user can't define the data block up to DB5.DBW32, but up to DB5.DBW34 or more.

**SIEMENS S7-300 Ethernet(TCP Slave)**

Device	Bit Address	Word Address	Format	Notes
External Input node	I 0.0~2047.7	-----	DDDD.O	
External Output node	Q 0.0~2047.7	-----	DDDD.O	
Internal assistant node	M 0.0~8191.7	-----	DDDD.O	
Data Register Relay node	DBn_DBX 100000.0~25565535. 7	-----	DDDDDDDD.O	
Data Register Relay node	DBm_DBX 0.0~65535.7	-----	DDDDD.O	m:1~10
Data Register Relay	-----	DBn_DBW 100000-25565534	DDDDDDDD	n:1~255
Data Register Relay (32 bit)	-----	DBn_DBD 100000-25565532	DDDDDDDD	n:1~255

Data Register Relay	-----	DBm_DBW 0-65534	DDDDD	m:1~1 0
Data Register Relay (32 bit)	-----	DBm_DBD 0-65532	DDDDD	
Internal Relay	-----	MW 0~8190	DDDD	
Internal Relay (32 bit)	-----	MD 0~2044	DDDD	
External Output Relay	-----	QW 0~2046	DDD	
External Output Relay (32 bit)	-----	QD 0~2044	DDD	
External Input Relay	-----	IW 0~2046	DDD	
External Input Relay (32 bit)	-----	ID 0~2044	DDD	
Internal Relay(byte)		MB 0~8191	DDDD	
External Input Relay(byte)		IB 0~2047	DDDD	
External Output Relay(byte)		QB 0~2047	DDDD	
Data Register Relay(byte)		DBm_DBB 0-65535	DDDDD	m:1~10
Data Register Relay(byte)		DBn_DBB100000-25565535	DDDDD	n:1~255

**NOTE:**

1. DBn\_DBX, DBn\_DBW, DBn\_DBD is a custom block. First three data formats for data block number, the address after the five, less than five former address zeros. To DB20.DBX23.4 example, EV5000 software addresses to DBn\_DBX: 2000023.4
2. The initial address of DBm.DBW, DBm.DBD must be an even number.
3. The data type of MB, IB, QB registers can't be set to signed int.
4. Make sure that the data block defined in PLC should be more than the data block used in HMI. For example, if DB5.DBW32 is used in HMI, user can't define the data block up to DB5.DBW32, but up to DB5.DBW34 or more.

**SIEMENS S7-400 Ethernet(TCP Slave)**

Device	Bit Address	Word Address	Format	Notes
External Input node	I 0.0~1023.7	-----	DDD.O	
External Output node	Q 0.0~1023.7	-----	DDD.O	
Internal assistant node	M 0.0~8191.7	-----	DDDD.O	
Data Register Relay node	DBn_DBX 100000.0~25565535. 7	-----	DDDDDDDD.O	
Data Register Relay node	DBm_DBX 0.0~65535.7	-----	DDDDD.O	m:1~10
Data Register Relay	-----	DBn_DBW 100000-25565534	DDDDDDDD	
Data Register Relay (32 bit)	-----	DBn_DBD 100000-25565532	DDDDDDDD	
Data Register Relay	-----	DBm_DBW 0-65534	DDDDD	m:1~10
Data Register Relay (32 bit)	-----	DBm_DBD 0-65532	DDDDD	



Internal Relay	-----	MW 0~8190	DDDD	
Internal Relay (32 bit)	-----	MD 0~8188	DDDD	
External Output Relay	-----	QW 0~1022	DDD	
External Output Relay (32 bit)	-----	QD 0~1020	DDD	
External Input Relay	-----	IW 0~1022	DDD	
External Input Relay (32 bit)	-----	ID 0~1020	DDD	

NOTE:

1. DBn\_DBX, DBn\_DBW, DBn\_DBD is a custom block. First three data formats for data block number, the address after the five, less than five former address zeros. To DB20.DBX23.4 example, EV5000 software addresses to DBn\_DBX: 2000023.4
2. The initial address of DBm.DBW, DBm.DBD must be an even number.
3. Make sure that the data block defined in PLC should be more than the data block used in HMI. For example, if DB5.DBW32 is used in HMI, user can't define the data block up to DB5.DBW32, but up to DB5.DBW34 or more.

#### SIEMENS LOGO! Ethernet(TCP Slave)

Device	Bit Address	Word Address	Format	Notes
Input	I_Bit 1-64	-----	DD	Read Only
Output	Q_Bit 1-64	-----	DD	
Flag Bit	M_Bit 1-112	-----	DDD	
Network Input	NI_Bit 1-128	-----	DDD	
Network Output	NQ_Bit 1-128	-----	DDD	
V Relay	V_Bit 0.0-1469.7	-----	DDDDo	
Analog Input	-----	AI_Word 1-16	DD	
Analog Output	-----	AQ_Word 1-16	DD	
Analog Mark	-----	AM_Word 1-64	DD	
Network Analog Input	-----	NAI_Word 1-64	DD	
Network Analog Onput	-----	NAQ_Word 1-32	DD	
V memory	-----	VW_Word 0-1468	DDDD	
V memory double word	-----	VD_Word 0-1466	DDDD	

NOTE: VD、VW address must be an even number

### © Cable Diagram

#### SIEMENS S7-200 protocol

##### RS232 communication

Siemens models using standard serial PC / PPI cable . Cable Baud Rate DIP switch settings are as follows:

- 1 ) with 5 DIP switch cable

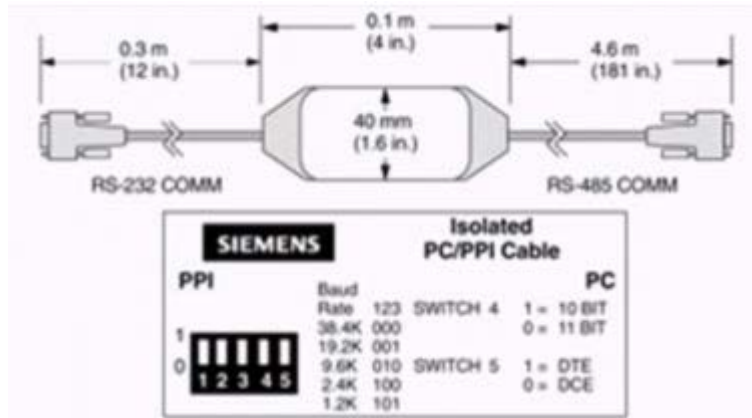

PC/PPI Cable switch to select the baud rate

Baud	SWITCH (1=on)
38400	000
19200	001
9600	010
4800	011
2400	100
1200	101

2) with 8 DIP switch cable

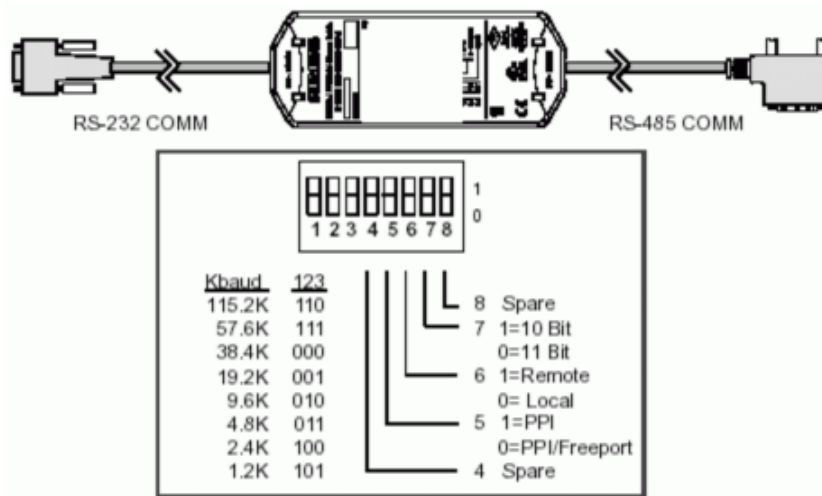

PC/PPI Cable switch to select the baud rate

Baud	SWITCH (1=on)
115200	110
57600	111
38400	000
19200	001
9600	010
4800	011
2400	100
1200	101

Note: The switch 5 is set to 0 , the selected item Freeport;the switch 6,7,8 is set to 0.

PC / PPI cable on the baud rate DIP switch settings, you must set the baud rate with the PLC and PC SET PG / PC Interface match the settings , Siemens S7-200 PLC baud rate can be programmed via STEP7-Micro/WIN software settings.

**RS485 communication**

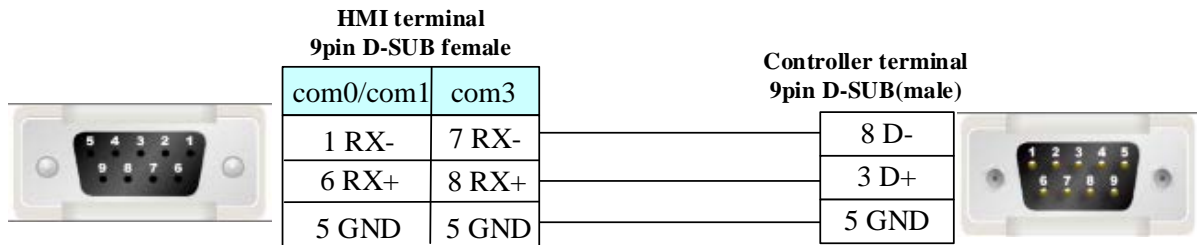

**SIEMENS S7-300/400 (PC Adapter Direct) protocol**

**RS232 communication**

**MT5-S7-300 PC Adapter communication cable**

Need to add a communication cable in adapter RS232 terminal

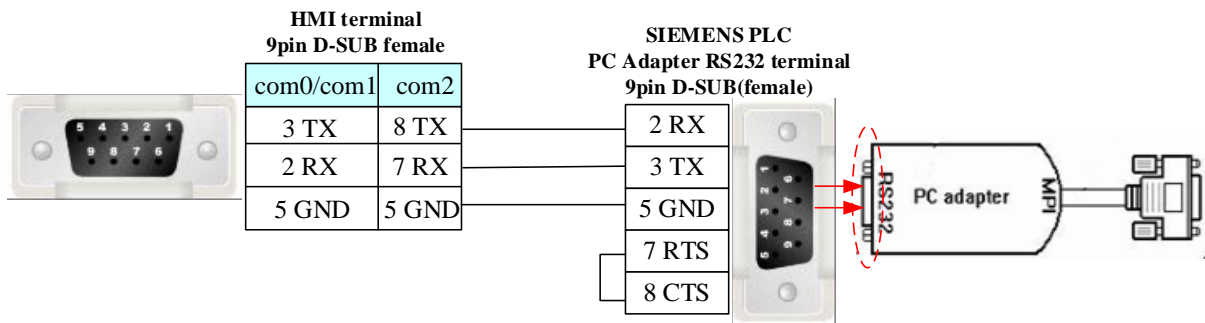

**SIEMENS S7-300/400 (MPI Direct) protocol**

**RS485 communication**

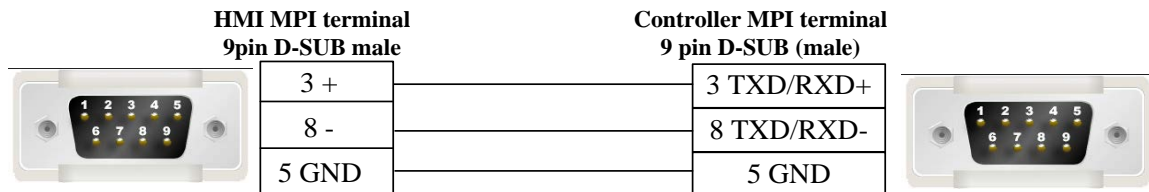

**SIEMENS MPI protocol**

**RS485 communication**

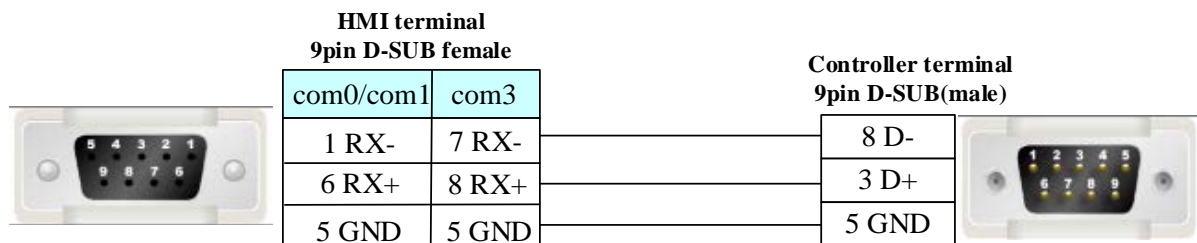

**Long distance communication with MPI adapter:**

The cable length must be 600m or less in the 187.5k ,the 7 pin and 2 pin must connect with 24V power in the port of RS485, the 8 pin and 3 pin must connect with 120 Ω terminal resistance.

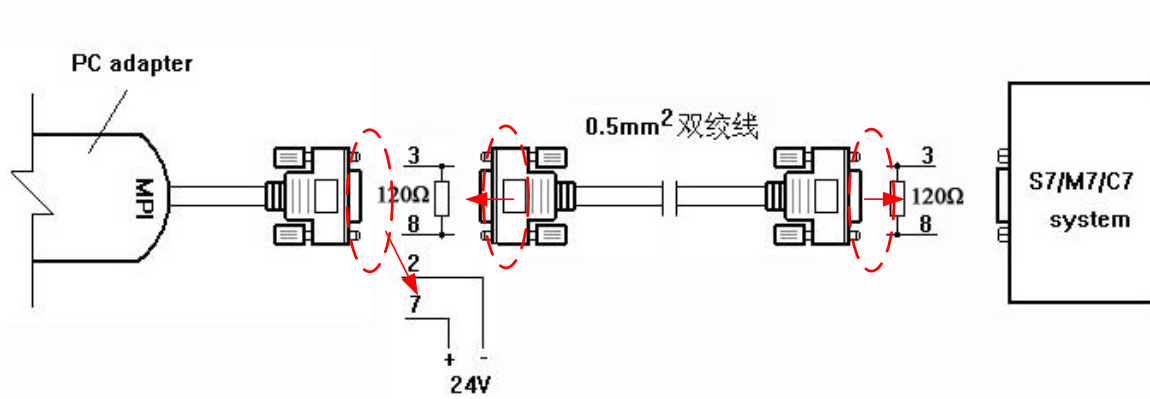

### Ethernet communication protocol cable

Cross-connection or crossover network cable can be used as communication cable via the hub

Refer to [3.3 Download by Network Ethernet](#) for method of making connection cable.

## 4.74 SIKO AG05 SIKONETZ5

### ◎ Serial Communication

Series	CPU	Link Module	Driver
Siko AG05	AG05	Port on CPU unit	SIKO AG05 SIKONETZ5

### ◎ Serial System configuration

Series	CPU	Link Module	COM Type	Parameter	Cable
Siko AG05	AG05	CPU Direct	RS485	<a href="#">Setting</a>	<a href="#">Your owner cable</a>

### ◎ Communication Setting

#### HMI Setting

Default parameter: 57600bps, 8, none, 1, station: 1

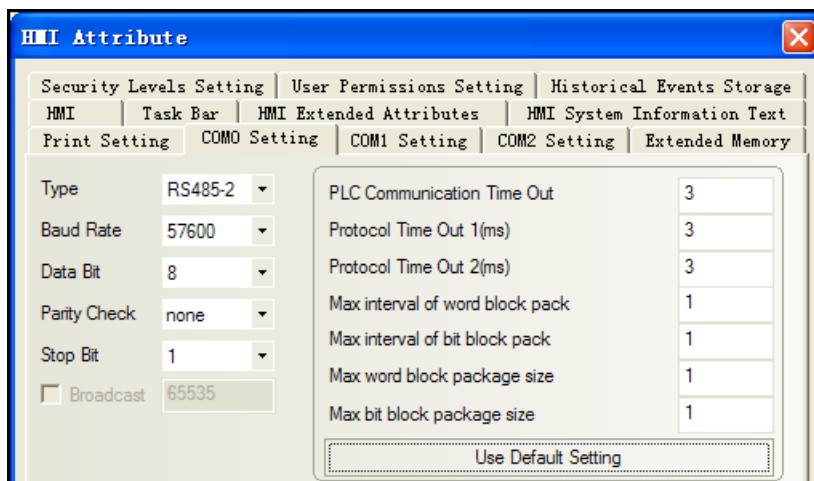

**PLC Setting**

Please reference to controller manual.

**Supported Device**

Device	Bit Address	Word Address	Format	Notes
Parameter No.	-----	ID 0-FF	HH	
SW	-----	SW 0-0	D	
CW	-----	CW 0-0	D	

**Note** Direct online simulation disable

**Cable Diagram**

RS485

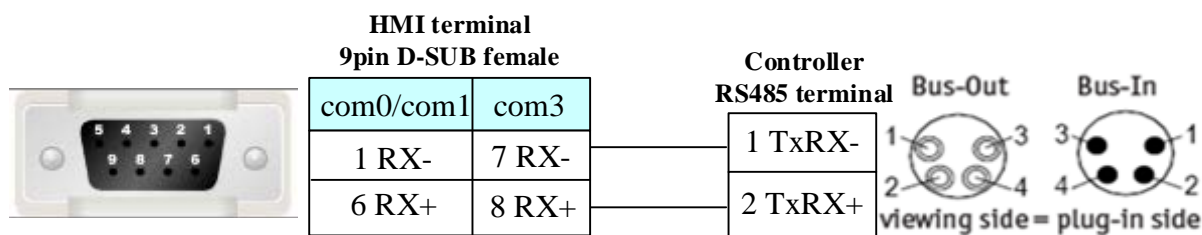

**4.75 Sinocon Sc1n**

**Serial Communication**

Series	CPU	Link Module	Driver
SC1N	SC1N-30T-2AD2DA	RS232 on the CPU unit	Sinocon Sc1n

**System configuration**

Series	CPU	Link Module	COMM Type	Parameter	Cable
SC1N	SC1N-30T-2A D2DA	RS232 on the CPU unit	RS232/RS485	<a href="#">Setting</a>	<a href="#">Your owner cable</a>

### ◎ Communication Setting

#### HMI setting

Default parameter: 9600bps, 7, even, 1, station: 1

#### RS232

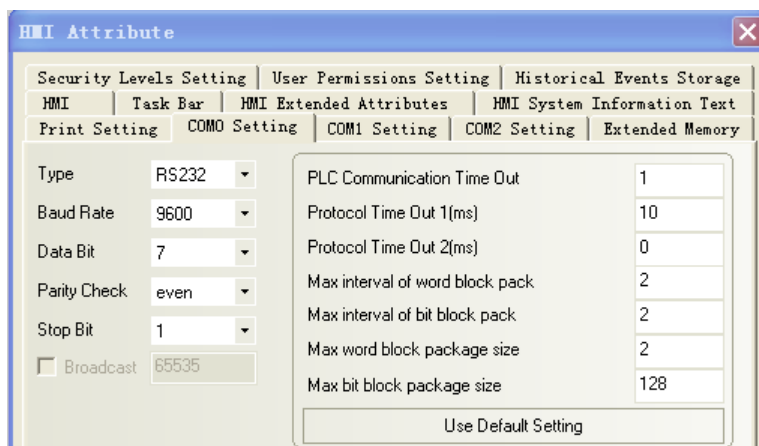

#### RS485

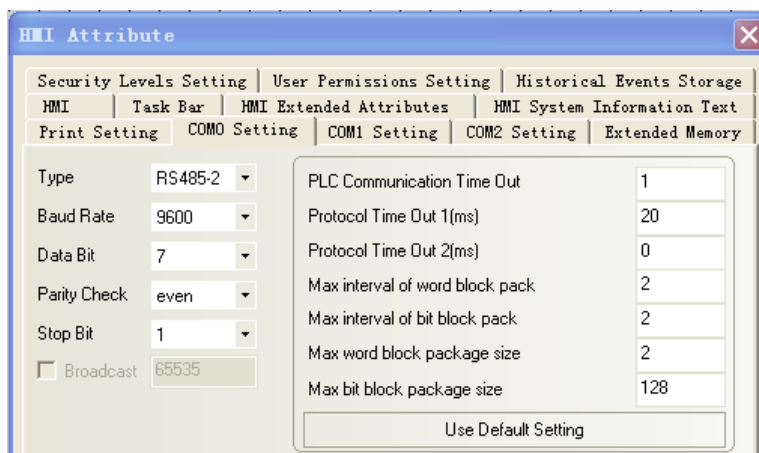

### ◎ Supported Device

Device	Bit Address	Word Address	Format	Notes
Input Relay	X 000-377	-----	OOO	
Output Relay	Y 000-377	-----	OOO	
Data Contact	D_bit 0.0-7999.F	-----	DDDD.F	
Internal Relay	M 0000-3071	-----	DDDD	
Timer Contact	T 000-255	-----	DDD	
Counter Contact	C 000-255	-----	DDD	
Special Internal Relay	SM 8000-8255	-----	DDDD	
State	S 000-999	-----	DDD	

Timer Value	-----	T_word 000-255	DDD	
Counter Value	-----	C_word 000-199	DDD	
Data Register	-----	D_word 0000-7999	DDDD	
Special Data Register	-----	SD_word 8000-8255	DDDD	
Counter Value	-----	C_dword 200-255	DDD	32 bit device

◎ Cable Diagram

RS232

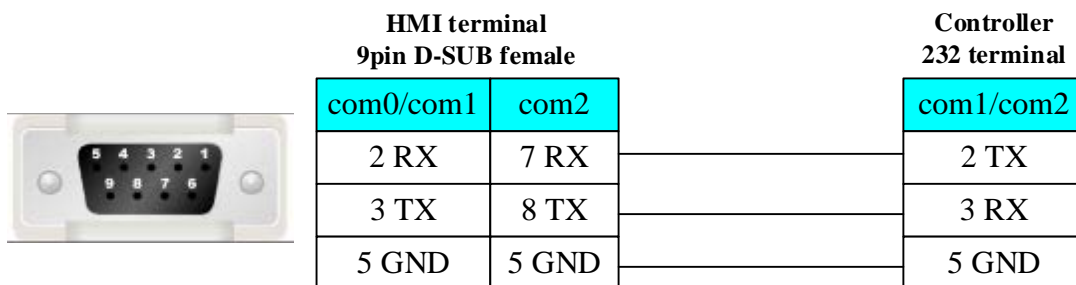

RS485

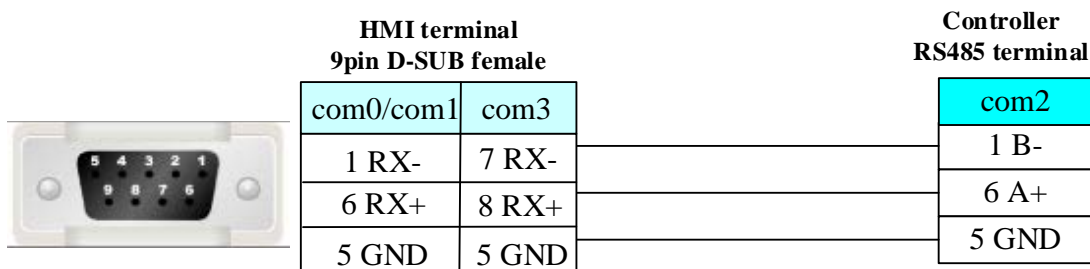

4.76 TAIAN

◎ Serial Communication

Series	CPU	Link Module	Driver
Taian	TOP3-30HR-A	RS232 on the CPU unit	Taian
		RS485 on the CPU unit	

◎ System configuration

Series	CPU	Link Module	COMM Type	Parameter	Cable
Taian	TOP3-30HR-A	RS232 on the CPU unit	RS232	<a href="#">Setting</a>	<a href="#">Your owner cable</a>
		RS485 on the CPU unit	RS485	<a href="#">Setting</a>	<a href="#">Your owner cable</a>

◎ Communication Setting

HMI Setting

Default communication: 19200, 8, none, 1; station: 1

### RS232 communication

**HMI Attribute**

HMI | Task Bar | HMI Extend Attribute | Historic Event

Print Setting | Serial Port 0 Setting | Serial Port 1 Setting

Type: RS232  
 Baud Rate: 19200  
 Data Bit: 8  
 Parity: none  
 Stop Bit: 1  
 Slave No.: 1

PLC Communication Time Out: 1  
 Protocol Time Out 1(ms): 3  
 Protocol Time Out 2(ms): 3  
 Max interval of block pack(WORDS): 2  
 Max interval of block pack(BITS): 8  
 Max block package size(WORDS): 16  
 Max block package size(BITS): 64

Use Default Setting

OK Cancel

### RS485 communication

**HMI Attribute**

HMI | Task Bar | HMI Extend Attribute | Historic Event | Print Setting

Serial Port 0 Setting | Serial Port 1 Setting | Serial Port 2 Setting

Type: RS485-2  
 Baud Rate: 19200  
 Data Bit: 8  
 Parity: none  
 Stop Bit: 1  
 Slave No.: 1

PLC Communication Time Out: 1  
 Protocol Time Out 1(ms): 3  
 Protocol Time Out 2(ms): 3  
 Max interval of block pack(WORDS): 2  
 Max interval of block pack(BITS): 8  
 Max block package size(WORDS): 16  
 Max block package size(BITS): 64

Use Default Setting

OK Cancel

It takes effect when HMI as slave

## © Supported Device

Device	Bit Address	Word Address	Format
Input Relay (receive external switch signal)	X0-377	-----	OOO
Output Relay	Y0-377	-----	OOO
Auxiliary Relay	M (0-7679) & (8000-8511)	-----	DDDD
Step Relay	S0-4096	-----	DDDD
Timer Relay	T0-511	-----	DDD
Counter Relay	C0-255	-----	DDD
Data Register	-----	D0-8511	DDDD
Data Register	-----	Z0-15	DD
Data Register	-----	V0-15	DD
Timer(Current value)	-----	T_Current_Word 0-511	DDD



Counter(Current value)	-----	C_Current_Word 0-199	DDD
Counter	-----	C_Current_Double 200-255	DDD
Timer(Preset value)	-----	T_Preset_Word 0-511	DDD
Counter(Preset value)	-----	C_Preset_Word 0-199	DDD
Counter	-----	C_Preset_Double 200-255	DDD

**NOTE:** Z, V is the turn of the write and read out. When testing a single word, max interval of word block pack and max word block package size are changed to 1.

### ◎ Cable Diagram

#### RS232 communication cable

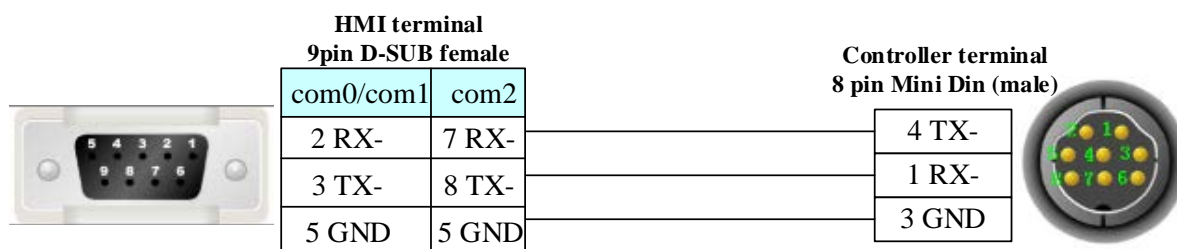

#### RS485 communication cable

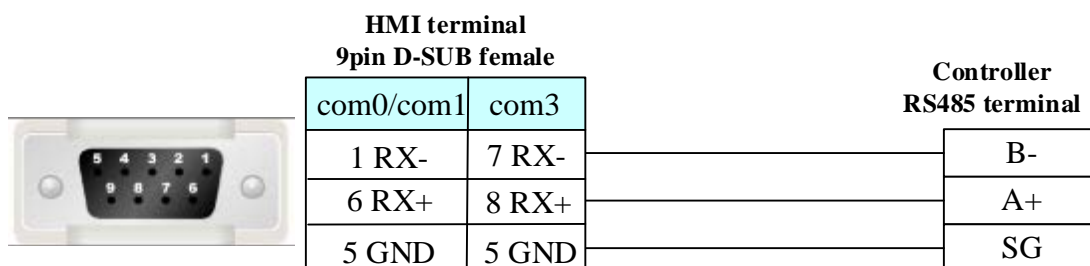

### 4.77 TMCM

#### ◎ Serial Communication

Series	CPU	Link Module	Driver
TMCM_303		RS232 on the CPU unit	TMCM_303
TMCM-6110	TMCM-6110	RS485 on the CPU unit	<b>TMCM_6110</b>

#### ◎ System configuration

Series	CPU	Link Module	COMM Type	Parameter	Cable
TMCM_303		RS232 on the CPU unit	RS232	<a href="#">Setting</a>	<a href="#">Your owner cable</a>
TMCM-6110		RS485 on the CPU unit	RS485	<a href="#">Setting_</a>	<a href="#">Your owner cable</a>

#### ◎ Communication Setting

TMCM\_303:

### HMI Setting

Default communication: 9600, 8, none, 1; station: 1

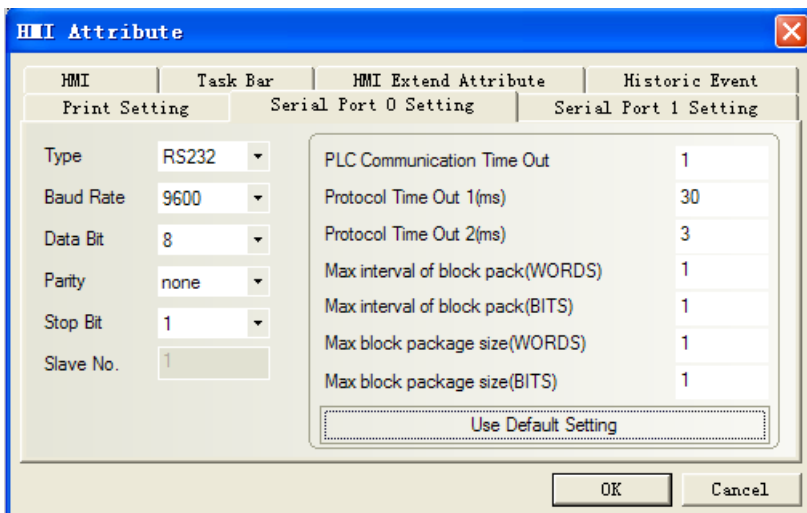

### TMCM\_6110:

#### HMI Setting

Default communication parameters: 9600, 8, none, 1; station: 1

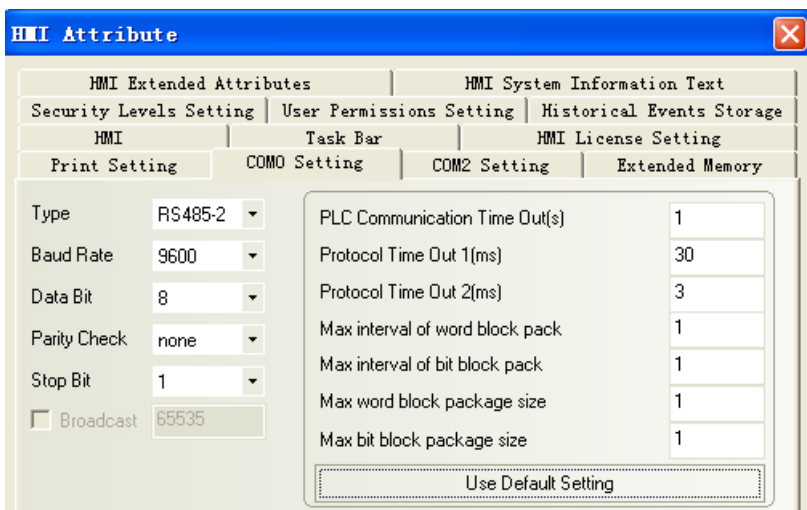

### PLC Setting

communication parameters setting:

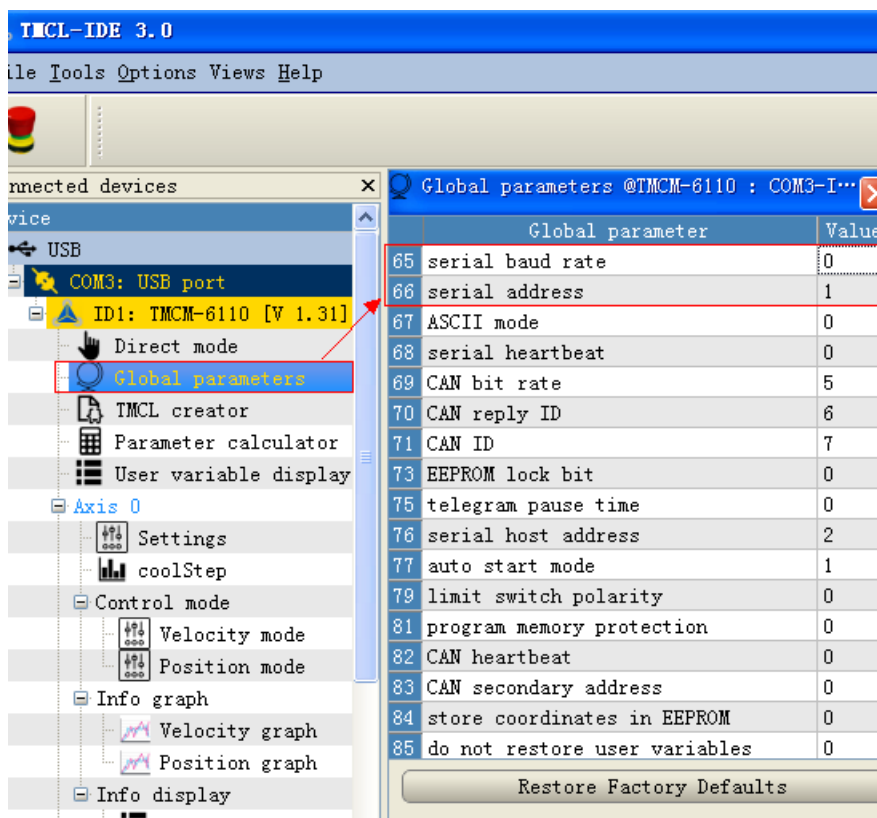

Serial baud rate value	Serial baud rate	
0	9600 baud	Default
1	14400 baud	
2	19200 baud	
3	28800 baud	
4	38400 baud	
5	57600 baud	
6	76800 baud	Not supported by Windows !
7	115200 baud	
8	230400 baud	
9	250000 baud	Not supported by Windows !
10	500000 baud	Not supported by Windows !
11	1000000 baud	Not supported by Windows !

### ©Supported Device

Please refer to TMCL Reference Manual for device details

#### TMCM\_303

Device	Bit Address	Word Address	Format	Notes
ROR	-----	0-2	D	Write Only
ROL	-----	0-2	D	Write Only

MST	0-2	-----	D	Write Only
MVP	-----	0.0-2.7	DD.D	Write Only
SAP	0.008-0.013 1.008-1.013 2.008-2.013	0.0-2.213	DDDD.DDD	Write Only
GAP	0.008-0.013 1.008-1.013 2.008-2.013	0.0-2.213	DDDD.DDD	Read Only
STAP	0.0-2.213	-----	DDDD.DDD	Write Only
RSAP	0.0-2.213	-----	DDDD.DDD	Write Only
SGP	0.077 0.129	0.0-0.038 0.64-0.81 0.128-0.132 1.0-1.11 2.0-2.19	DDDD.DDD	Write Only
GGP	0.077 0.129	0.0-0.038 0.64-0.81 0.128-0.132 1.0-1.11 2.0-2.19	DDDD.DDD	Read Only
RFS	-----	DWord 0.0-2.2	DD.D	Write Only
SIO	0-7	-----	D	Write Only
GIO	0.0-0.10 2.0-2.07	1.0-1.7	DDD.DD	Read Only
CALC	-----	0-9	D	Write Only
COMP	-----	0	D	Write Only
JC	-----	0-9	DD	Write Only
JA	-----	0	D	Write Only
CSUB	-----	0	D	Write Only
RSUB	0	-----	D	Write Only
WAIT	-----	0.0-4.7	DD.D	Write Only
STOP	0	-----	D	Write Only

**TMCN\_6110**

Device	Bit Address	Word Address	Format
STOP	0-0	-----	D
RSUB	0-0	-----	D
SIO	0-7	-----	D
RSGP	0.000-255.255	-----	DDD.DDD
STGP	0.000-255.255	-----	DDD.DDD

RSAP	0.000-255.255	-----	DDD.DDD
STAP	0.000-255.255	-----	DDD.DDD
MST	0-5	-----	D
WAIT	-----	0.000-4.255	D.DDD
CSUB	-----	0-0	D
JA	-----	0-0	D
JC	-----	0-12	DD
COMP	-----	0-0	D
CALC	-----	0-9	D
GIO	-----	0.000-255.255	DDD.DDD
RFS	-----	0.000-2.255	D.DDD
GGP	-----	0.000-255.255	DDD.DDD
SGP	-----	0.000-255.255	DDD.DDD
GAP	-----	0.000-255.255	DDD.DDD
SAP	-----	0.000-255.255	DDD.DDD
MVP	-----	0.000-2.255	D.DDD
ROL	-----	0-5	D
ROR	-----	0-5	D

NOTE: The address format of registers is [type].[motor].c

## ◎ Cable Diagram

### RS232 Communication Cable

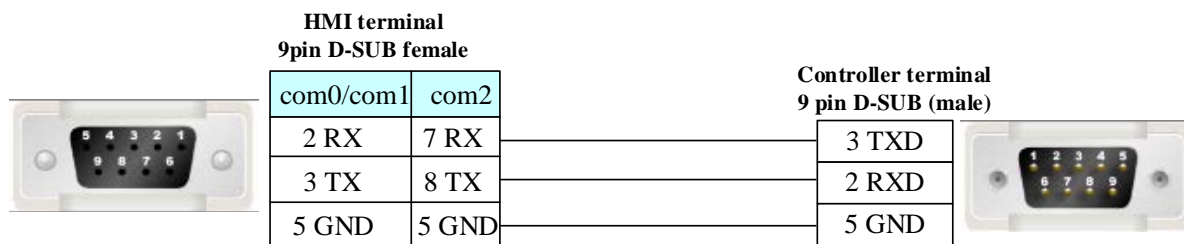

### RS485 Communication Cable

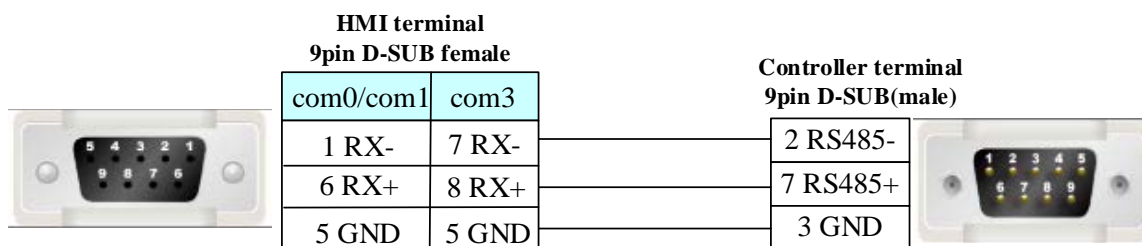

## 4.78 Toledo DLoadCell

### ◎ Serial Communication

Series	CPU	Link Module	Driver
D3CellTM	D3CellTM	RS422 on the CPU unit	DLoadCell

### ◎ System configuration

Series	CPU	Link Module	COMM Type	Parameter	Cable
D3CellTM	D3CellTM	RS485 on the CPU unit	RS422	<a href="#">Setting</a>	<a href="#">Your owner cable</a>

### ◎ Supported Device

For detailed device, please refer to the PLC manual.

### ◎ Communication Setting

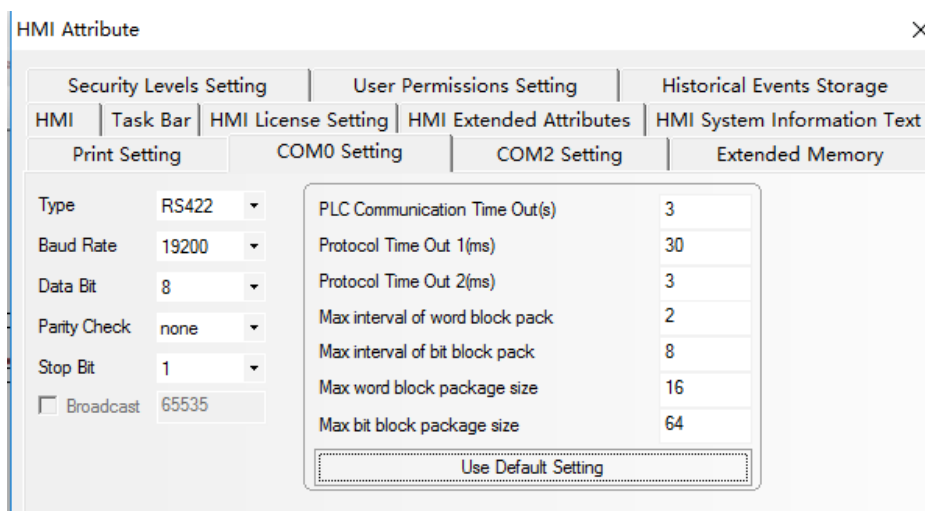

### ◎ Cable Diagram

#### RS422 Communication Cable

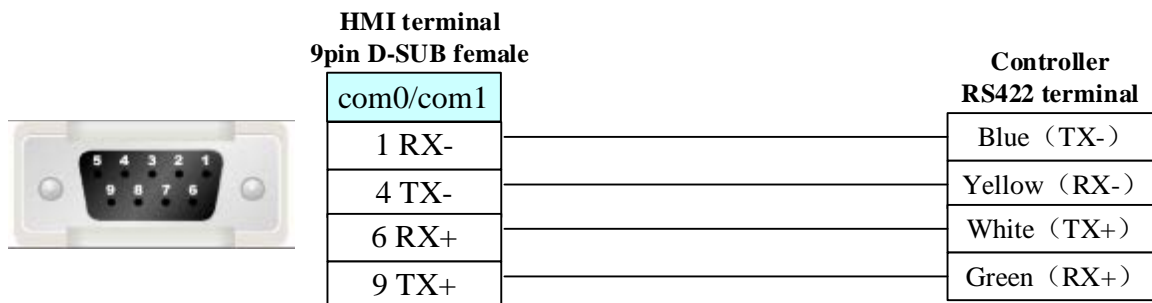

## 4.79 Toshiba

### ◎ Network Communication

Series	CPU	Link Module	Driver
V30	TCXMAIN1	Ethernet interface on CPU	Toshiba V30 Ethernet (TCP Slave)
V-series	S2PU72A	Ethernet interface on CPU	<b>Toshiba S2PU72A Ethernet (TCP Slave)</b>

### ◎ Network System configuration

Series	CPU	Connect Type	Parameter	Cable
ToShiBaV30	TCXMAIN1	Ethernet	<a href="#">Setting</a>	<a href="#">Your owner cable</a>
V-series	S2PU72A	Ethernet	<a href="#">Setting</a>	<a href="#">Your owner cable</a>

### ◎ Network Communication Setting

#### HMI setting

TCXMAIN1:

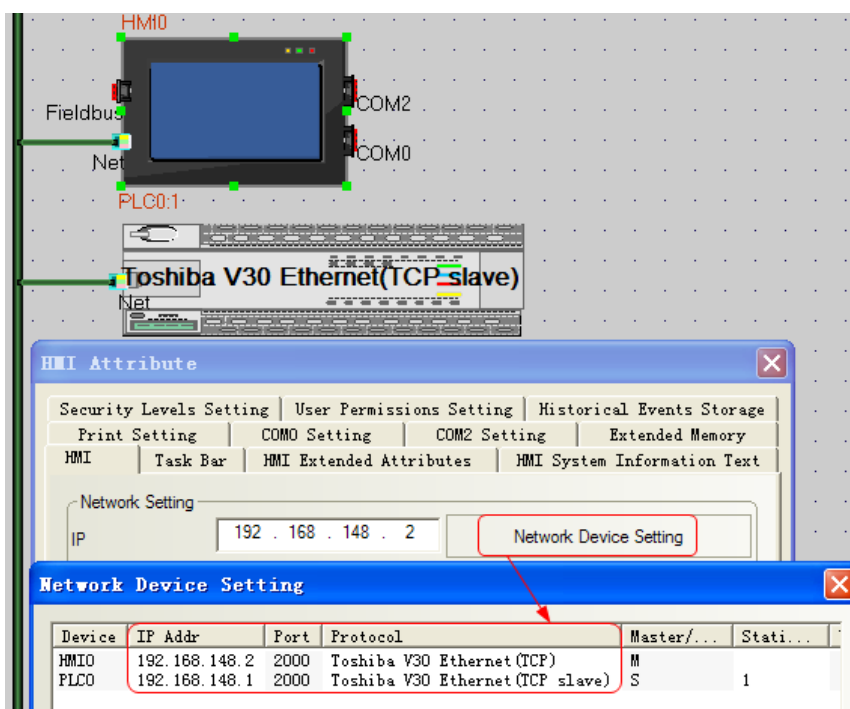

S2PU72A:

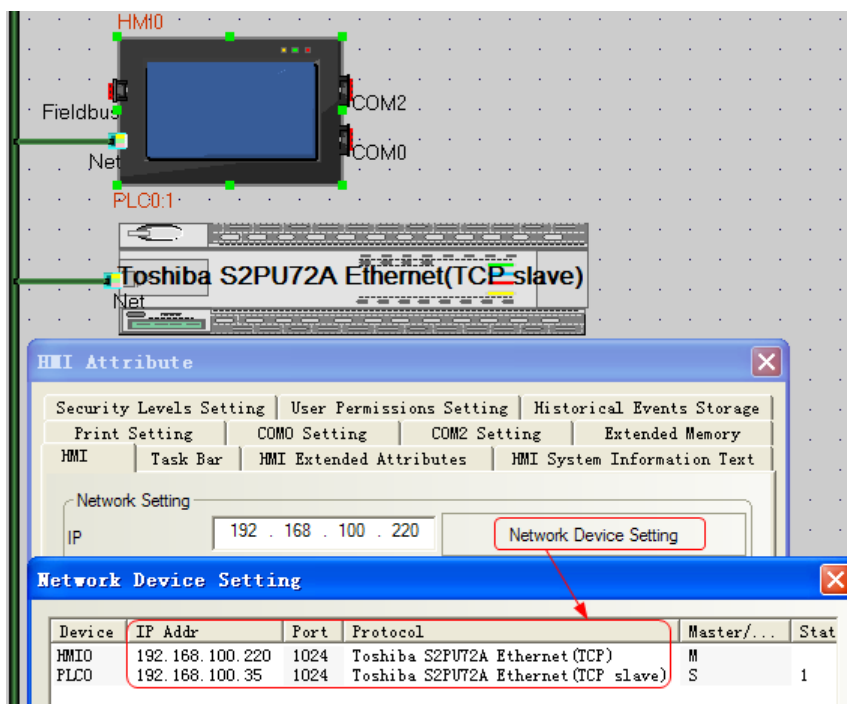

### PLC setting

Please refer to the communication equipment related documentation to set the parameter.

### ◎ Supported Device

TCXMAIN1:

Device	Bit Address	Word Address	Format
0x00000000-0x0000FFFF	R00_B 0.00-FFFF.1F	-----	HHHH.HH
0x01000000-0x0100FFFF	R01_B 0.00-FFFF.1F	-----	HHHH.HH
0x02000000-0x0200FFFF	R02_B 0.00-FFF.1F	-----	HHH.HH
0x03000000-0x0300FFFF	R03_B 0.00-FFF.1F	-----	HHH.HH
0x04000000-0x0400FFFF	R04_B 0.00-FFF.1F	-----	HHH.HH
0x05000000-0x0500FFFF	R05_B 0.00-FFF.1F	-----	HHH.HH
0x06000000-0x0600FFFF	R06_B 0.00-FFF.1F	-----	HHH.HH
0x07000000-0x0700FFFF	R07_B 0.00-FFF.1F	-----	HHH.HH
0x08000000-0x0800FFFF	R08_B 0.00-FFFF.1F	-----	HHHH.HH
0x09000000-0x0900FFFF	R09_B 0.00-FFF.1F	-----	HHH.HH
0x0A000000-0x0A00FFFF	R0A_B 0.00-FFF.1F	-----	HHH.HH
0x0B000000-0x0B00FFFF	ROB_B 0.00-FFFF.1F	-----	HHHH.HH
0x0C000000-0x0C00FFFF	ROC_B 0.00-FFFF.1F	-----	HHHH.HH
0x0D000000-0x0D00FFFF	R0D_B 0.00-FFF.1F	-----	HHH.HH
0x0E000000-0x0E00FFFF	ROE_B 0.00-FFF.1F	-----	HHH.HH
0x0F000000-0x0F00FFFF	ROF_B 0.00-FFF.1F	-----	HHH.HH
0x10000000-0x1000FFFF	R10_B 0.00-FFF.1F	-----	HHH.HH
0x11000000-0x1100FFFF	R11_B 0.00-FFF.1F	-----	HHH.HH
0x12000000-0x1200FFFF	R12_B 0.00-FFFF.1F	-----	HHHH.HH
0x13000000-0x1300FFFF	R13_B 0.00-FFF.1F	-----	HHH.HH
0x14000000-0x1400FFFF	R14_B 0.00-FFF.1F	-----	HHH.HH



0x15000000-0x15000FFF	R15_B 0.00-FFF.1F	-----	HHH.HH
0x17000000-0x17007FFF	R17_B 0.00-7FFF.1F	-----	HHHH.HH
0x41000000-0x4100FFFF	R41_B 0.00-FFFF.1F	-----	HHHH.HH
0x51000000-0x5100FFFF	R51_B 0.00-FFFF.1F	-----	HHHH.HH
0x52000000-0x52000FFF	R52_B 0.00-FF.1F	-----	HH.HH
0x61000000-0x6107FFFF	R61_B 0.00-7FFF.1F	-----	HHHH.HH
0x62000000-0x62003FFF	R62_B 0.00-3FFF.1F	-----	HHHH.HH
0x63000000-0x63003FFF	R63_B 0.00-3FFF.1F	-----	HHHH.HH
0x64000000-0x64003FFF	R64_B 0.00-3FFF.1F	-----	HHHH.HH
0x65000000-0x65003FFF	R65_B 0.00-3FFF.1F	-----	HHHH.HH
0x66000000-0x66003FFF	R66_B 0.00-3FFF.1F	-----	HHHH.HH
0x67000000-0x67003FFF	R67_B 0.00-3FFF.1F	-----	HHHH.HH
0x68000000-0x68003FFF	R68_B 0.00-3FFF.1F	-----	HHHH.HH
0x69000000-0x69003FFF	R69_B 0.00-3FFF.1F	-----	HHHH.HH
0x6A000000-0x6A003FFF	R6A_B 0.00-3FFF.1F	-----	HHHH.HH
0x6B000000-0x6B003FFF	R6B_B 0.00-3FFF.1F	-----	HHHH.HH
0x6C000000-0x6C003FFF	R6C_B 0.00-3FFF.1F	-----	HHHH.HH
0x6D000000-0x6D003FFF	R6D_B 0.00-3FFF.1F	-----	HHHH.HH
0x6E000000-0x6E003FFF	R6E_B 0.00-3FFF.1F	-----	HHHH.HH
0x6F000000-0x6F000FFF	R6F_B 0.00-FFF.1F	-----	HHH.HH
0x00000000-0x0000FFFF	-----	R00 0-FFFF	HHHH
0x01000000-0x0100FFFF	-----	R01 0-FFFF	HHHH
0x02000000-0x0200FFF	-----	R02 0-FFF	HHH
0x03000000-0x0300FFF	-----	R03 0-FFF	HHH
0x04000000-0x0400FFF	-----	R04 0-FFF	HHH
0x05000000-0x0500FFF	-----	R05 0-FFF	HHH
0x06000000-0x0600FFF	-----	R06 0-FFF	HHH
0x07000000-0x0700FFF	-----	R07 0-FFF	HHH
0x08000000-0x0800FFFF	-----	R08 0-FFFF	HHHH
0x09000000-0x0900FFF	-----	R09 0-FFF	HHH
0x0A000000-0x0A00FFF	-----	ROA 0-FFF	HHH
0x0B000000-0x0B00FFFF	-----	ROB 0-FFFF	HHHH
0x0C000000-0x0C00FFFF	-----	ROC 0-FFFF	HHHH
0x0D000000-0x0D00FFF	-----	ROD 0-FFF	HHH
0x0E000000-0x0E00FFF	-----	ROE 0-FFF	HHH
0x0F000000-0x0F00FFF	-----	ROF 0-FFF	HHH
0x10000000-0x1000FFF	-----	R10 0-FFF	HHH
0x11000000-0x1100FFF	-----	R11 0-FFF	HHH
0x12000000-0x1200FFFF	-----	R12 0-FFFF	HHHH
0x13000000-0x1300FFF	-----	R13 0-FFF	HHH

0x14000000-0x14000FFF	-----	R14 0-FFF	HHH
0x15000000-0x15000FFF	-----	R15 0-FFF	HHH
0x17000000-0x17007FFF	-----	R17 0-7FFF	HHHH
0x41000000-0x4100FFFF	-----	R41 0-FFFF	HHHH
0x51000000-0x5100FFFF	-----	R51 0-FFFF	HHHH
0x52000000-0x520000FF	-----	R52 0-FF	HH
0x61000000-0x6107FFFF	-----	R61 0-7FFF	HHHH
0x62000000-0x62003FFF	-----	R62 0-3FFF	HHHH
0x63000000-0x63003FFF	-----	R63 0-3FFF	HHHH
0x64000000-0x64003FFF	-----	R64 0-3FFF	HHHH
0x65000000-0x65003FFF	-----	R65 0-3FFF	HHHH
0x66000000-0x66003FFF	-----	R66 0-3FFF	HHHH
0x67000000-0x67003FFF	-----	R67 0-3FFF	HHHH
0x68000000-0x68003FFF	-----	R68 0-3FFF	HHHH
0x69000000-0x69003FFF	-----	R69 0-3FFF	HHHH
0x6A000000-0x6A003FFF	-----	R6A 0-3FFF	HHHH
0x6B000000-0x6B003FFF	-----	R6B 0-3FFF	HHHH
0x6C000000-0x6C003FFF	-----	R6C 0-3FFF	HHHH
0x6D000000-0x6D003FFF	-----	R6D 0-3FFF	HHHH
0x6E000000-0x6E003FFF	-----	R6E 0-3FFF	HHHH
0x6F000000-0x6F000FFF	-----	R6F 0-FFF	HHH

S2PU72A:

Device	Bit Address	Word Address	Format
XX	0.0-3071.F	-----	DDDD.F
RR	0.0-4095.F	-----	DDDD.F
SS	0.0-511.F	-----	DDD.F
X_WORD	-----	0-3071	DDDD
R_WORD	-----	0-4095	DDDD
S_WORD	-----	0-511	DDD

### © Cable Diagram

Refer to [3.3 Download by Network Ethernet](#)

## 4.80 Trio motion controller

### © Serial Communication

Series	CPU	Link Module	Driver
Euro	Euro 205x	RS232 on the CPU unit	TRIO
			Modbus RTU Extend
MC	MC405	RS232 on the CPU unit	Trio (mode7)

◎ Network communication

Series	CPU	Link Module	Driver
MC	MC405	Ethernet on the CPU	Trio TCP-IP(TCP Slave)

◎ Serial System configuration

Series	CPU	Link Module	COMM Type	Parameter	Cable
TRIO	Euro 205x	RS232 on the CPU unit	RS232	<a href="#">Setting</a>	<a href="#">Your owner cable</a>
		RS485 on the CPU unit	RS422	<a href="#">Setting</a>	<a href="#">Your owner cable</a>
Modbus RTU Extend	Euro 205x	RS232 on the CPU unit	RS232	<a href="#">Setting</a>	<a href="#">Your owner cable</a>
		RS485 on the CPU unit	RS422	<a href="#">Setting</a>	<a href="#">Your owner cable</a>
Trio (mode7)	MC405	RS232 on the CPU unit	RS232	<a href="#">Setting</a>	<a href="#">Your owner cable</a>
		RS485 on the CPU unit	RS422	<a href="#">Setting</a>	<a href="#">Your owner cable</a>

◎ Network System configuration

Series	CPU	Link Module	Connect Type	Parameter	Cable
Trio	MC405	Ethernet on the CPU	Ethernet	<a href="#">Setting</a>	<a href="#">Your owner cable</a>

◎ Serial Communication Setting

TRIO protocol

HMI Setting

Default communication: 9600, 7, even, 2; station: 1

RS232 communication

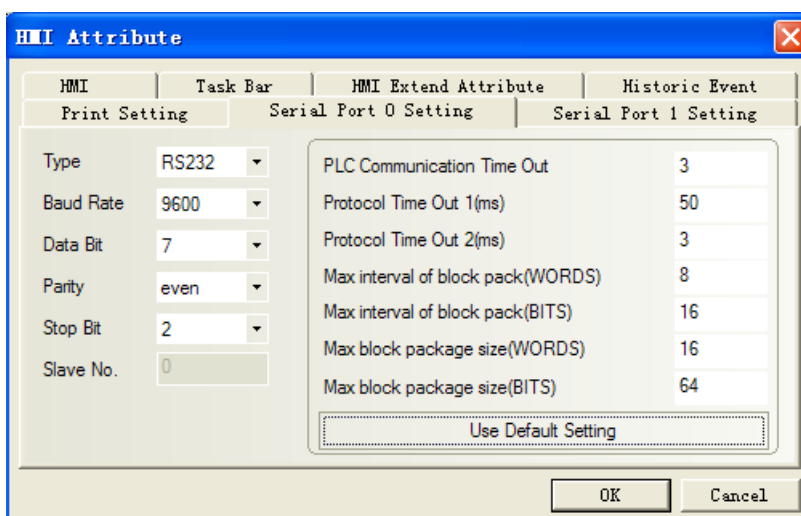

Controller internal setting:

```
HLS_NODE=1
HLS_MODEL=$FA
SETCOM(9600,7,2,2,1,5)
```

## RS422 communication

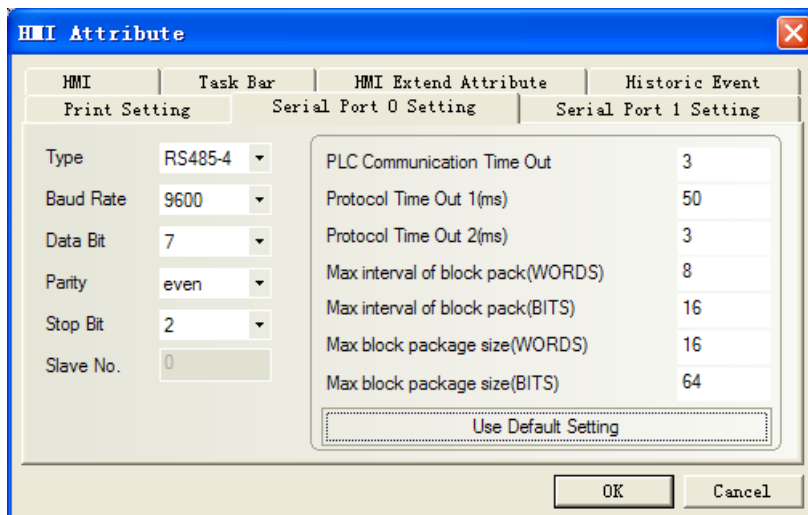

## Controller internal setting:

```
HLS_NODE=1
HLS_MODEL=$FA
SETCOM(9600,7,2,2,2,5)
```

## PLC Setting

### Select the HOST LINK protocol in the PLC program software

1. Define HOST LINK slave node

```
HLS_NODE=1
```

2. Define HOST LINK slave model

```
HLS_MODEL=$FA
```

3. Set up HOST LINK slave for port2.

Trio controller setting: SETCOM(baudrate, databits, stopbits, parity, port, 5)

```
SETCOM(9600,7,2,2,2,5)
```

## RS232 communication

```
HLS_NODE=1
HLS_MODEL=$FA
SETCOM(9600,7,2,2,1,5)
```

## RS422 communication

```
HLS_NODE=1
HLS_MODEL=$FA
SETCOM(9600,7,2,2,2,5)
```

## Modbus RTU Extend protocol

### HMI Setting

Default communication: 9600, 8, even, 1; station: 1

## RS232 communication

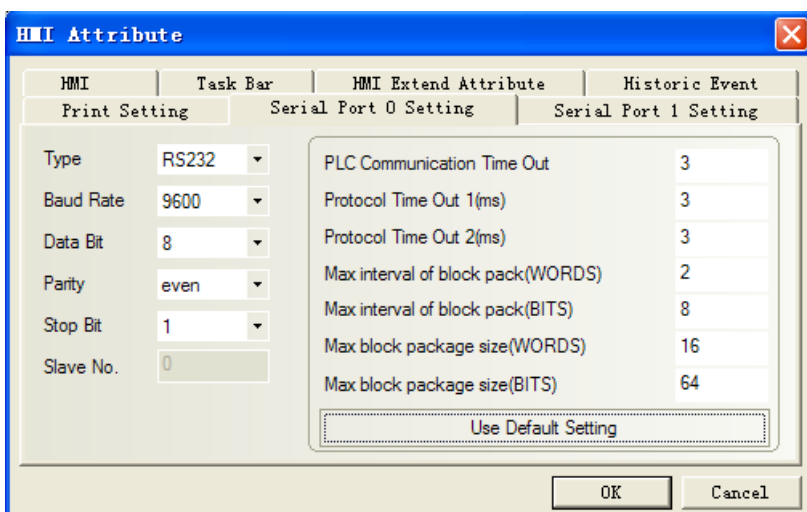

## RS422 communication

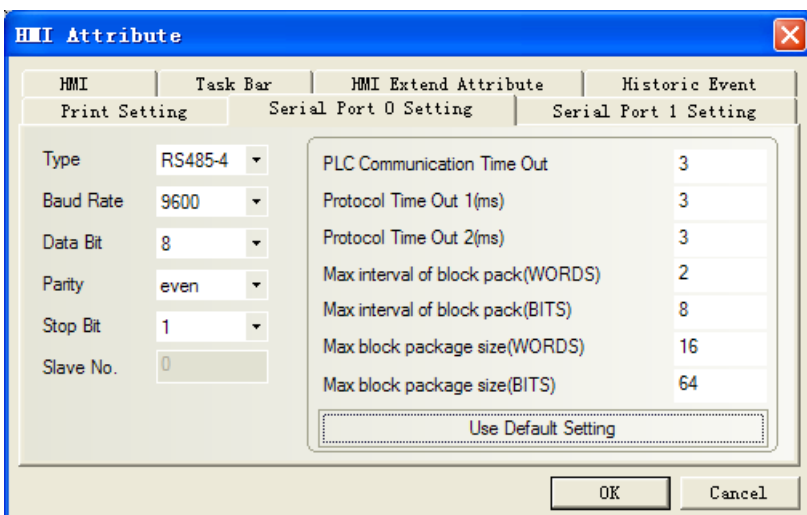

## PLC Setting

Modbus Protocol:

ADDRESS=1

SETCOM (9600,8,1,2,1,4)

## Trio(mode7) protocol

### HMI Setting

Default communication: 9600, 8, even, 1; station: 1

### RS232 communication

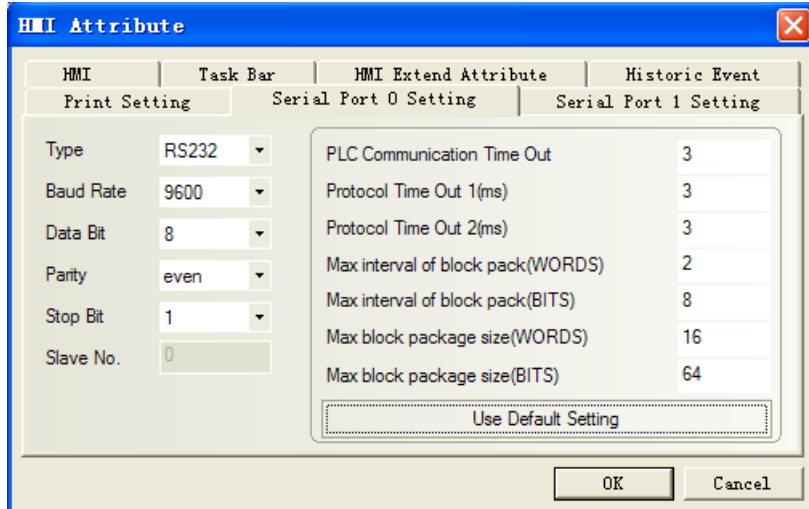

### RS422 communication

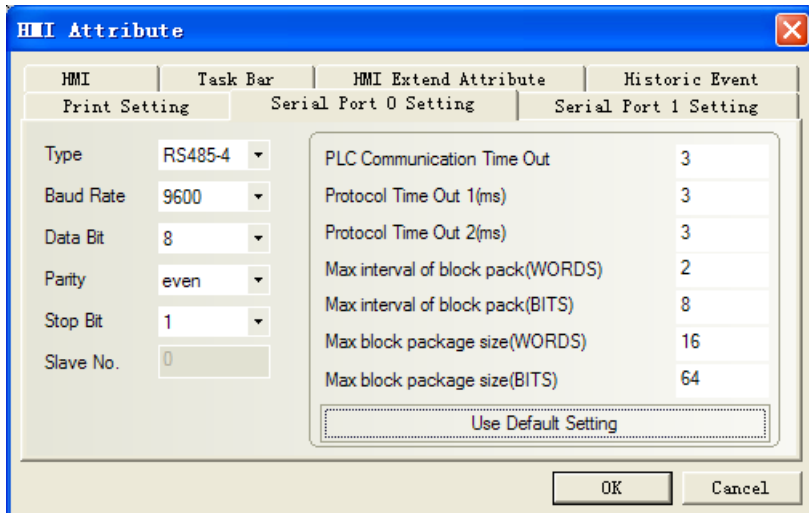

### PLC Setting

1. ADDRESS=1
2. Serial Interface Configuration :Chose VR ,32BIT IEEE floating point;Right click “STARTUP” to generate Serial port 1’ s project ; and click RUN

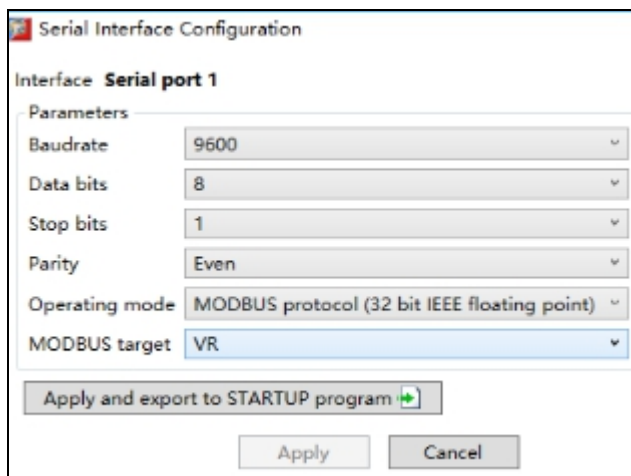

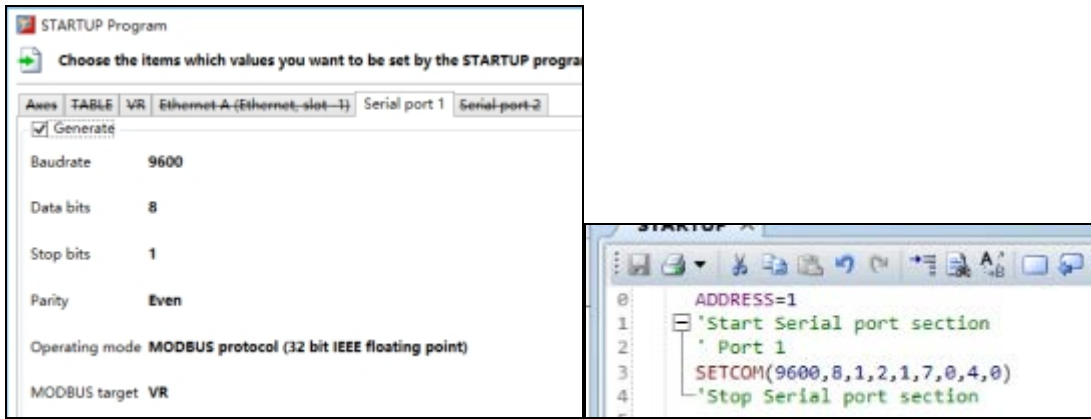

3. Next,Chose “VR ”register in HMI software, data type is float, then it can shows decimal,like 12.89;  
If chose “VR\_INT”, data type use unsigned INT,it can only shows Integer part,like12. Table register is the same

4. If u chose 32 bit long word:

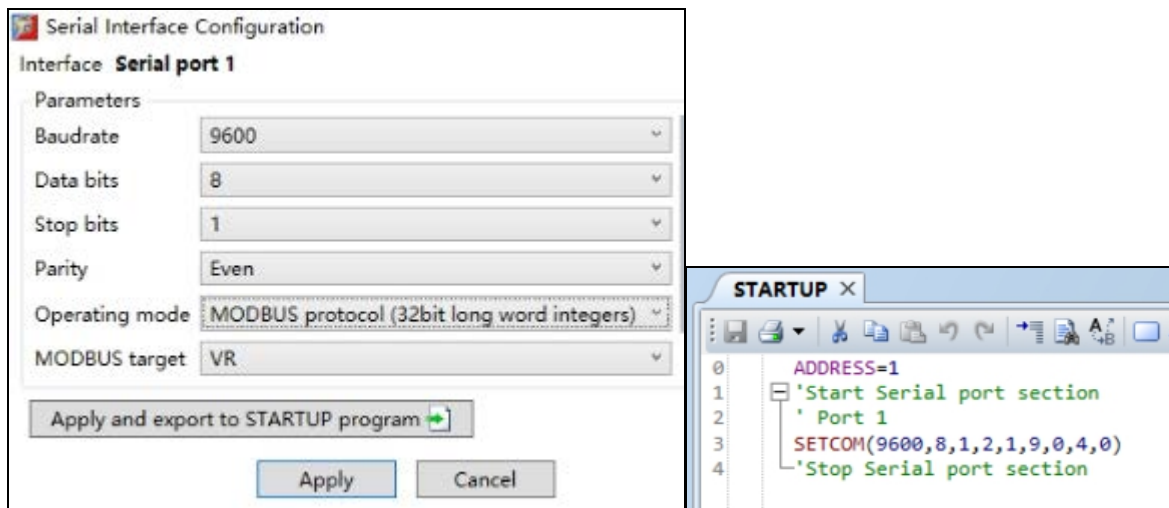

Then u can chose “VR” register, data type is unsigned INT, it can only shows Integer part;Table register is the same.

## ◎ Network Communication Setting

### HMI Setting

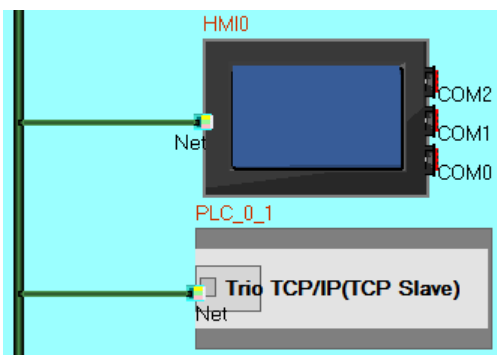

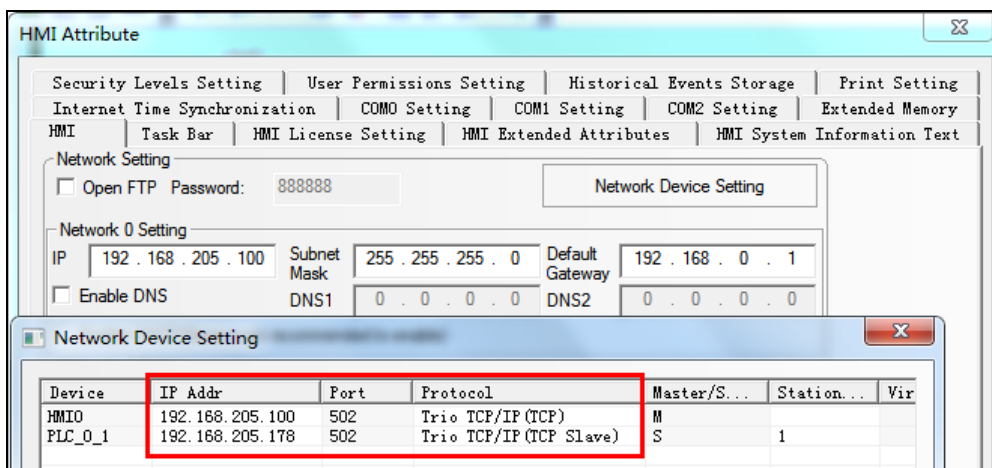

### PLC Setting

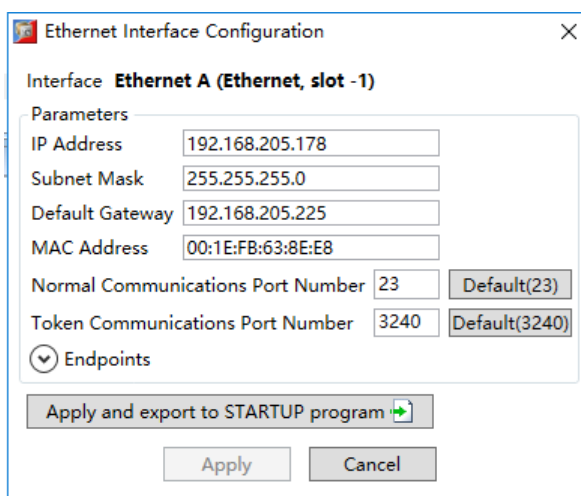

### © Supported Device

#### TRIO

Device	Bit Address	Word Address	Format	Notes
I/O and Internal Auxiliary Relay	IR 0.0-4095.15	-----	DDDD.DD	
Link Relay	LR 0.0-4095.15	-----	DDDD.DD	
Assistant Relay	AR 0.0-4095.15	-----	DDDD.DD	
Holding Relay	HR 0.0-4095.15	-----	DDDD.DD	
Data Memory	-----	DM 0-30000	DDDDD	
Timer/Counter	-----	TC 0-255	DDD	

**NOTE:** Address correspondence: IRn.m-->the m Trio VR (n); DMn->Table (n). Example IR1.02 corresponds to the 2nd bit of VR1.

#### Modbus RTU Extend

Device	Bit Address	Word Address	Format	Notes
Data register bit	4X_bit 0.0-1023.15	-----	DDDD.DD	
Data register	-----	4X 0-1023	DDDDD	

**NOTE:** Address correspondence: 4x corresponds to VR; 4x\_bit corresponds to VR's bit. Address difference



between one position, e.g. 4x (501) corresponds to VR (500); 4x\_bit (67.1) corresponds to the first bit of VR (66).

**Trio (mode 7)**

Device	Bit Address	Word Address	Format	Notes
Table_INT_Bit	0.0-30000.31	-----	DDDDD.DD	
Table_Bit	0.0-30000.31	-----	DDDDD.DD	
VR_INT_Bit	0.0-4095.31	-----	DDDD.DD	
VR_Bit	0.0-4095.31	-----	DDDD.DD	
Table_INT	-----	0-30000	DDDDD	
Table	-----	0-30000	DDDDD	
VR_INT	-----	0-4095	DDDD	
VR	-----	0-4095	DDDD	

**Trio TCP-IP(TCP Slave)**

Device	Bit Address	Word Address	Format	Notes
VR_Bit	0.00-4095.15	-----	DDDD. DD	
Table_Bit	0.00-4095.15	-----	DDDD. DD	
VR	-----	0-4095	DDDD	
Table	-----	0-4095	DDDD	

**© Cable Diagram**

**NOTE:** In the controller, A port is programming port, B port is communication port  
**Programming Cable**

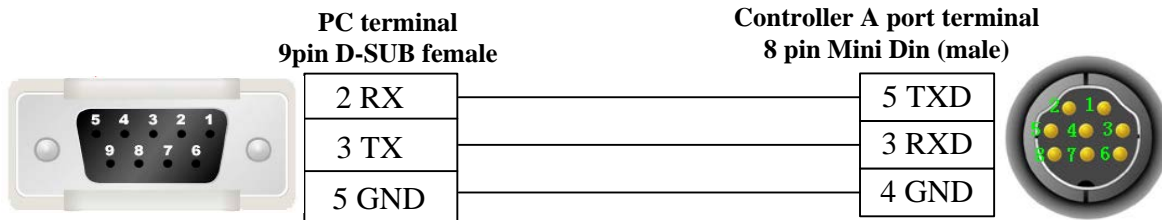

**RS232 Communication Cable**

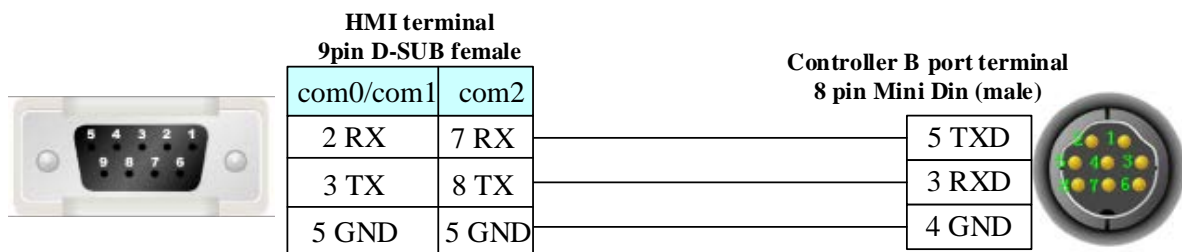

**RS422 Communication Cable**

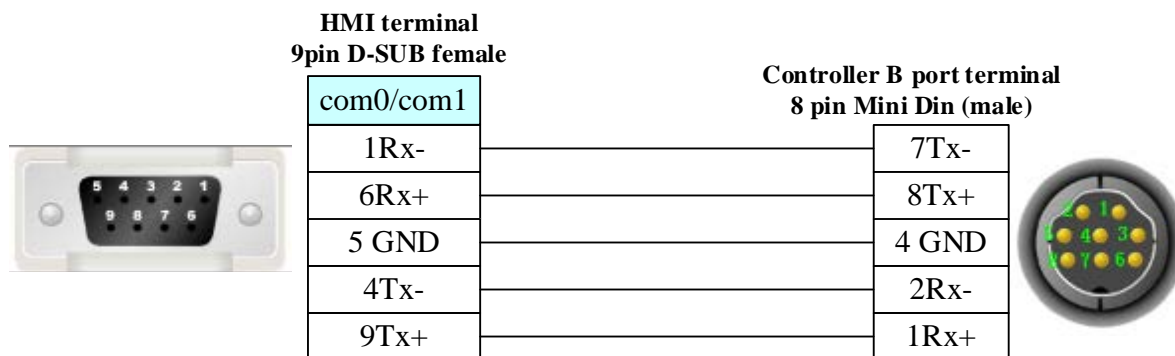

### Ethernet communication protocol cable

Cross-connection or crossover network cable can be used as communication cable via the hub

Refer to [3.3 Download by Network Ethernet](#) for method of making connection cable.

## 4.81 Unitronics

### ◎ Serial Communication

Series	CPU	Link Module	Driver
Vision 130	V130-33-B1	RS232 on the CPU unit	Unitronics
		RS485 on the CPU unit	

### ◎ Network Communication

Series	CPU	Link Module	Driver
Vision 130	V130-33-B1	Ethernet I/F on CPU Unit	Unitronics Ethernet(TCP Slave)

### ◎ Serial System configuration

Series	CPU	Link Module	COM Type	Parameter	Cable
Vision 130	V130-33-B1	RS232 on the CPU unit	RS232	<a href="#">Setting</a>	<a href="#">Your owner cable</a>
		RS485 on the CPU unit	RS485	<a href="#">Setting</a>	<a href="#">Your owner cable</a>

### ◎ Network System configuration

Series	CPU	Link Module	Connect Type	Parameter	Cable
Vision 130	V130-33-B1	Ethernet I/F on CPU Unit	Ethernet	<a href="#">Setting</a>	<a href="#">Your owner cable</a>

### ◎ Serial Communication Setting

#### HMI Setting

RS232 default communication: 57600, 8, 1, none; station: 1

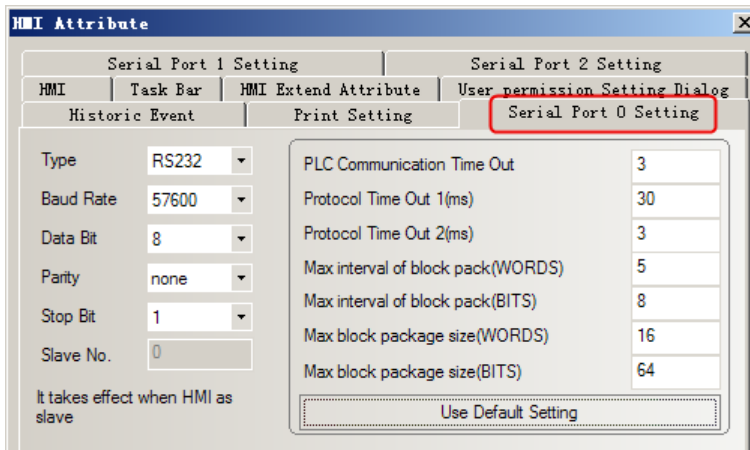

RS485 default communication: 57600, 8, 1, none; station: 64

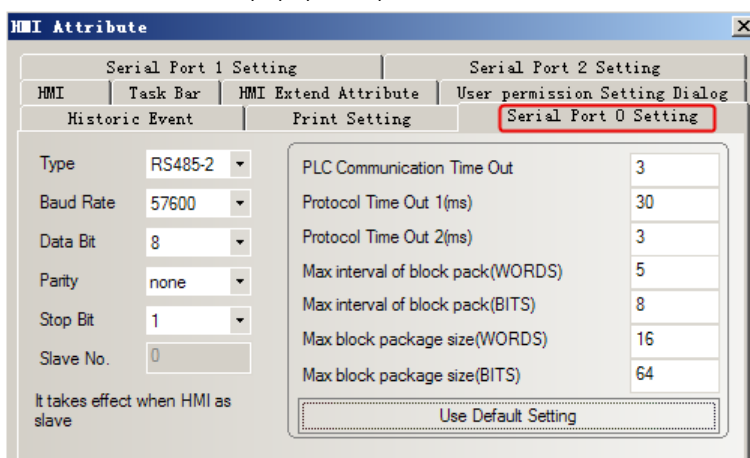

### PLC Setting

1. COM Initialize in the program software by RS485 communication.

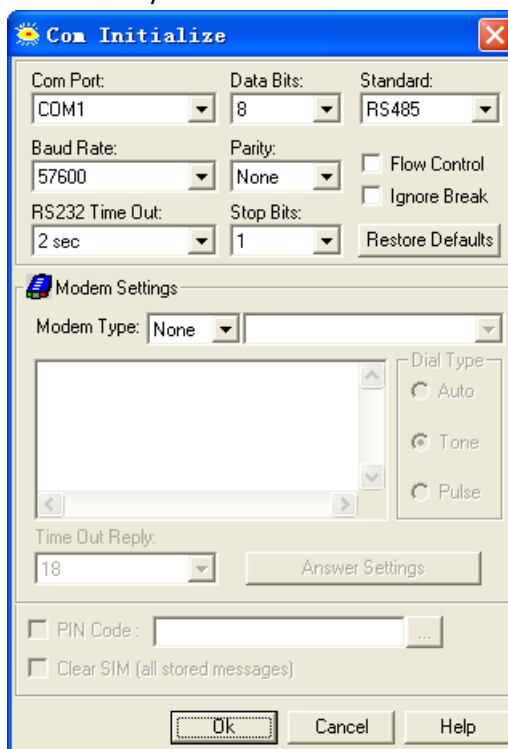

2. Initialize ID, and program as below, download to controller.

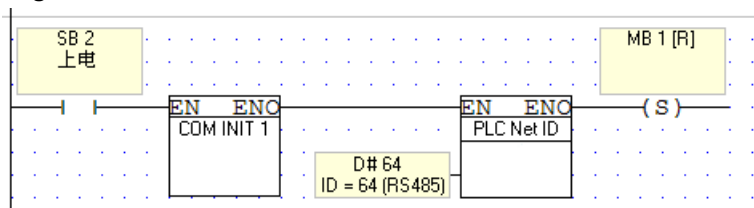

3. Change the jumper position and choose RS485 communication.

### ◎ Network Communication Setting

#### HMI Setting

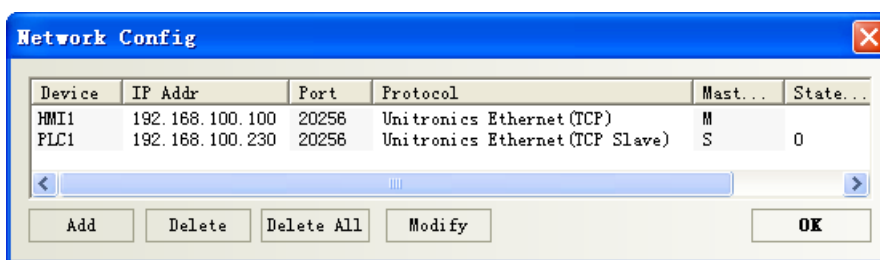
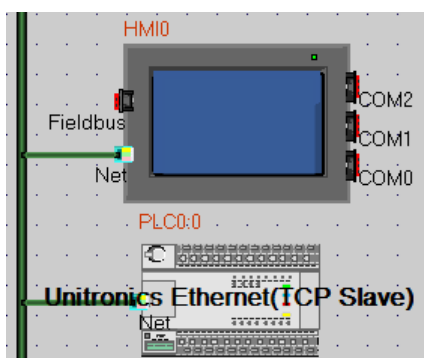

### ◎ Supported Device

Device	Bit Address	Word Address	Format	Notes
Inputs	I 0~999	-----	DDD	Read only
Outputs	O 0~999	-----	DDD	
Memory Bits	MB 0~8191	-----	DDDD	
System Bits	SB 0~999	-----	DDD	
Timers	T 0~383	-----	DDD	Read only
Counters	C 0~31	-----	DD	Read only
Memory Integer	-----	MI 0~4095	DDDD	
Memory Longer	-----	ML 0~511	DDD	
Double Word	-----	DW 0~255	DDD	
Memory Float	-----	MF 0~63	DD	
System Integer	-----	SI 0~999	DDD	
System Longer	-----	SL 0~199	DDD	
System Double Word	-----	SDW 0~199	DDD	
Timers Preset	-----	T_C 0~383	DDD	Read only
Timers Current	-----	T_P 0~383	DDD	Read only

Counters Preset	-----	C_C 0~31	DD	Read only
Counters Current	-----	C_P 0~31	DD	Read only

### ◎ Cable Diagram

#### RS232 communication cable

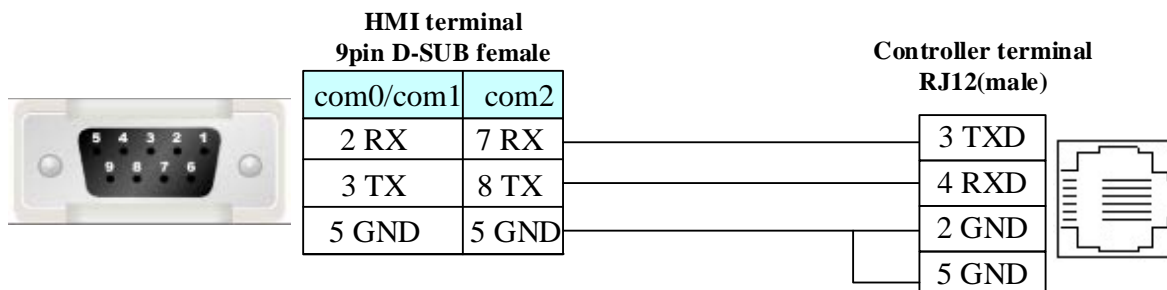

#### RS485 communication cable

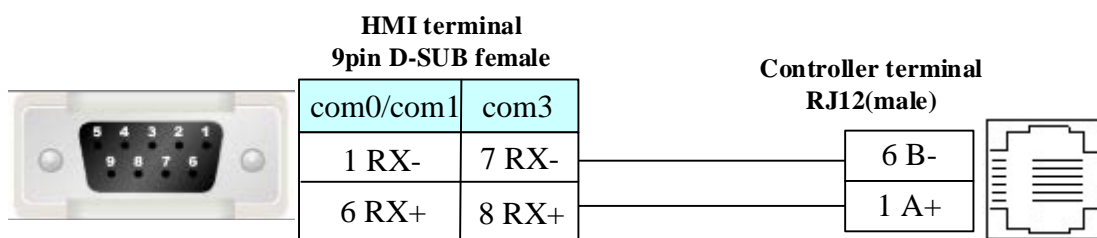

PLC RJ12 pins are defined as follow:

Pin Number	Function
1	A signal (+)
2	(RS232 signal) GND
3	(RS232 signal) TXD
4	(RS232 signal) RXD
5	(RS232 signal) GND
6	B signal (-)

#### Ethernet communication protocol cable

Cross-connection or crossover network cable can be used as communication cable via the hub

Refer to [3.3 Download by Network Ethernet](#) for method of making connection cable.

### 4.82 Universal Slave

#### ◎ Serial Communication

Series	CPU	Link Module	Driver
Universal ASCII Slave	Universal ASCII Slave	RS232 on the CPU unit	Universal ASCII Slave
Universal HEX Slave	Universal HEX Slave	RS232 on the CPU unit	Universal HEX Slave

#### ◎ System configuration

Series	CPU	Link Module	COM Type	Parameter	Cable
Universal ASCII Slave	Universal ASCII Slave	RS232 on the CPU unit	RS232	<a href="#">Setting</a>	<a href="#">Your owner cable</a>
Universal HEX Slave	Universal HEX Slave	RS232 on the CPU unit	RS232	<a href="#">Setting</a>	<a href="#">Your owner cable</a>

## ◎ Communication Setting

### HMI Setting

Default communication: 9600, 8, 1, none; station: 1

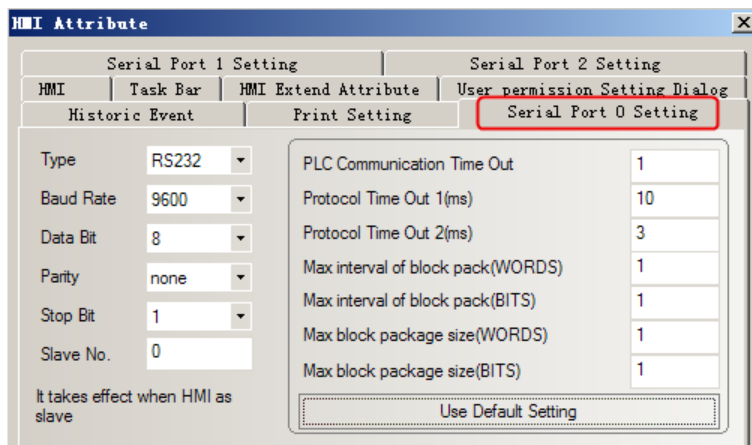

## ◎ Supported Device

### Universal ASCII Slave

Device	Bit Address	Word Address	Format	Notes
send	LB 0	-----	D	Correspond to COM0
clear	LB1	-----	D	
Send data buffer	-----	LW 0~99	DD	
Receive data buffer	-----	LW 100~199	DDD	
send	LB2	-----	D	Correspond to COM1
clear	LB3	-----	D	
Send data buffer	-----	LW 200~299	DD	
Receive data buffer	-----	LW 300~399	DDD	
send	LB 4	-----	D	Correspond to COM2
clear	LB5	-----	D	
Send data buffer	-----	LW400~499	DD	
Receive data buffer	-----	LW 500~599	DDD	
send	LB 6	-----	D	Correspond to COM3
clear	LB7	-----	D	
Send data buffer	-----	LW600~699	DD	
Receive data buffer	-----	LW 700~799	DDD	

### Universal HEX Slave

Device	Bit Address	Word Address	Format	Notes
--------	-------------	--------------	--------	-------

send	LB 0	-----	D	Correspond to COM0
clear	LB1	-----	D	
Send data buffer	-----	LW 0~99	DD	
Receive data buffer	-----	LW 100~199	DDD	
send	LB2	-----	D	Correspond to COM1
clear	LB3	-----	D	
Send data buffer	-----	LW 200~299	DD	
Receive data buffer	-----	LW 300~399	DDD	
send	LB 4	-----	D	Correspond to COM2
clear	LB5	-----	D	
Send data buffer	-----	LW400~499	DD	
Receive data buffer	-----	LW 500~599	DDD	

### ◎ Cable Diagram

#### RS232 communication cable

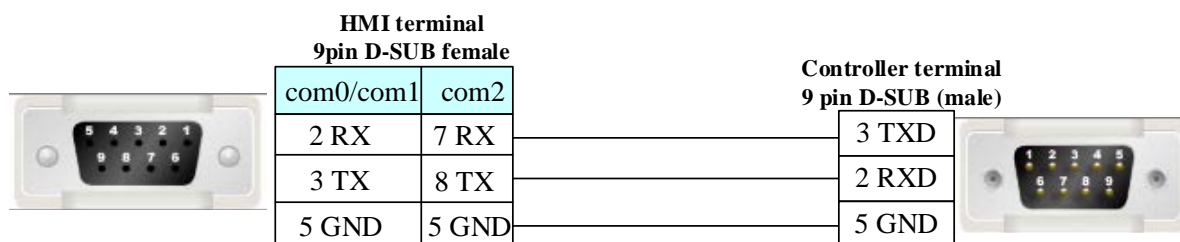

## 4.83 Vigor Corporation

### ◎ Serial Communication

Series	CPU	Link Module	Driver
VH	VH-14MR	RS232 on the CPU unit	Vigor
VB0	VB0-14MR	RS232 on the CPU unit	
VS1	VS1-10MT-D	RS485 CP1	Vigor VS

### ◎ System configuration

Series	CPU	Link Module	COMM Type	Parameter	Cable
VH	VH-14MR	RS232 on the CPU unit	RS232	<a href="#">Setting</a>	<a href="#">Your owner cable</a>
VB0	VB0-14MR	RS232 on the CPU unit	RS232	<a href="#">Setting</a>	<a href="#">Your owner cable</a>
VS1	VS1-10MT-D	RS485 CP1	RS485	<a href="#">Setting</a>	<a href="#">Your owner cable</a>

### ◎ Communication Setting

#### Vigor Protocol:

Default communication: 19200, 7, even, 1; station: 0

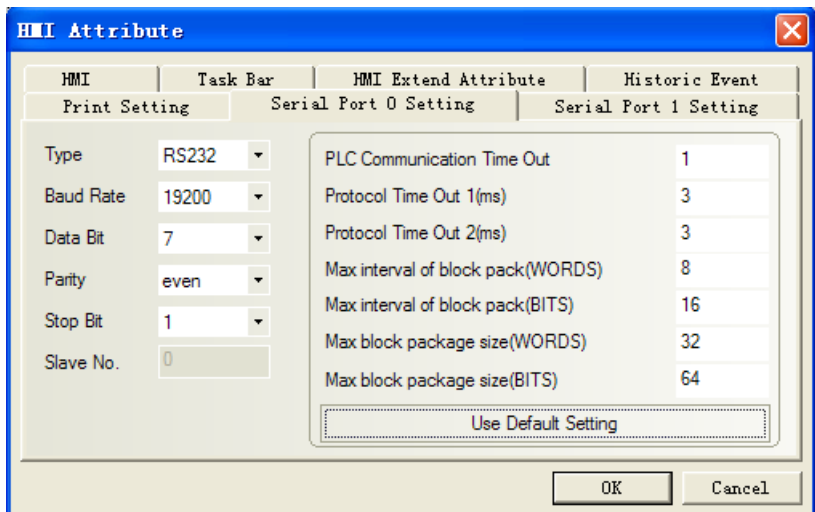

**NOTE:** CP1\* baudrate 19200bps.  
 \*: CP1 programming port is USB(RS232).

**Vigor VS Protocol:**

RS485: Default parameter: 19200, 8,1, None; Station No: 0

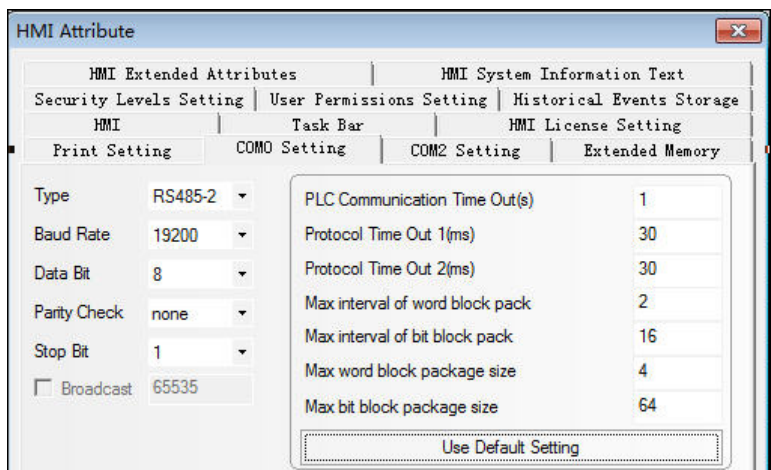

**PLC Setting**

Set the same parameters as the HMI does.

© **Supported Device**

Vigor Protocol

Device	Bit Address	Word Address	Format	Notes
Input Relay	X 0-777	-----	OOO	
Output Relay	Y 0-777	-----	OOO	
Internal Relay	M 0-5119	-----	DDDD	
Special Relay	SM 9000-9255	-----	DDDD	
Timer Relay	T_bit 0-255	-----	DDD	
Counter Relay	C_bit 0-255	-----	DDD	
Timer	-----	T_word 0-255	DDD	



Counter	-----	C_word 0-199	DDD	
Counter double word	-----	C_dword 200-255	DDD	
Data Register	-----	D 0-8191	DDDD	
Special Data Register	-----	SD 9000—9255	DDDD	

## Vigor VS Protocol

Device	Bit Address	Word Address	Format	Notes
Input Relay	X 0-377	-----	OOO	
Output Relay	Y 0-377	-----	OOO	
Internal Relay	M 0-8191	-----	DDDD	
Special Relay	SM 0-511	-----	DDD	
Data Register D (bit)	D_BIT 0.0-8999.F	-----	DDDD.H	
Data Register R (bit)	R_BIT 0.0-25999.F	-----	DDDDD.H	
Step Relay	S 0-4095	-----	DDDD	
Timer Coil	T_XQ 0-511		DDD	
Timer Contact	T_JD 0-511		DDD	
Counter Coil	C_XQ 0-255		DDD	
Counter Contact	C_JD 0-255		DDD	
Timer	-----	T_WORD 0-511	DDD	
Counter	-----	C_WORD 0-199	DDD	
Counter (32 bit)	-----	C_DWORD 200-255	DDD	
Data Register D	-----	D_WORD 0-8999	DDDD	
Special Data Register	-----	SD_WORD 0-511	DDDD	
Data Register R	-----	R_WORD 0-25999	DDDDD	

## © Cable Diagram

### VH-14MR RS232 communication cable

#### 1. Communication via USB programming port

Connection with HMI by programming cable of Vigor

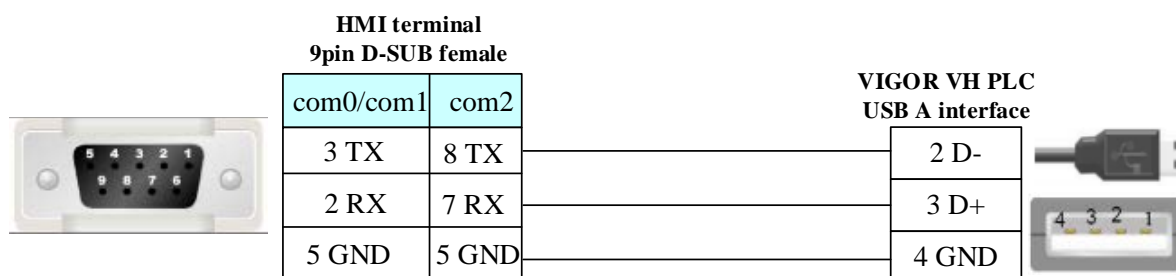

#### 2. Communication via auxiliary interface of programming device:

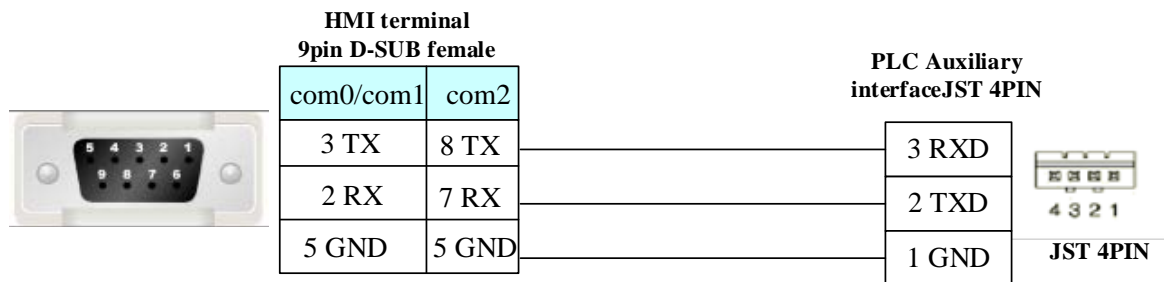

3. RS485 communication cable

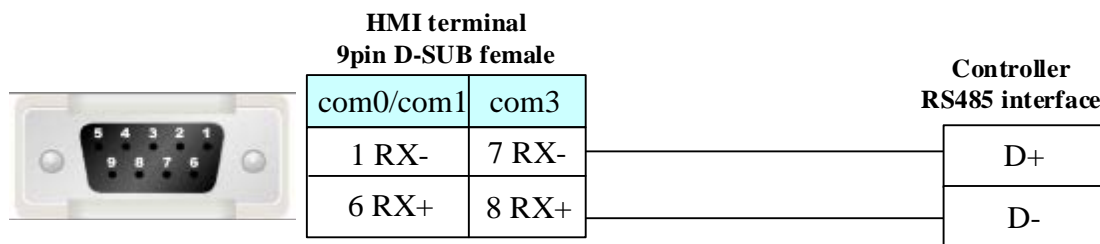

### 4.84 XINJE Controller

#### Serial Communication

Series	CPU	Link Module	Driver
XINJE XC	XC3-32R-E	RS232 on the CPU unit	Modbus RTU
			XINJE XC Series
XINJE XDM	XDM-60T10-E	RS232 on the Port 1	XINJE XDM Series
		RS485 on the Port 2	

#### Network communication

Series	CPU	Link Module	Driver
XINJE XD	XD5/XDM/XDC/XD5E/XL5/ XL5E/XLME	CPU Direct	XINJE XD Series(TCP Slave)

#### Serial System configuration

Series	CPU	Link Module	COM Type	Parameter	Cable
XINJE XC	XC3-32R-E	RS232 on the CPU unit	RS232	<a href="#">Setting</a>	<a href="#">Your owner cable</a>
XINJE XDM	XDM-60T10-E	RS232 on the Port 1	RS232	<a href="#">Setting</a>	<a href="#">Your owner cable</a>
		RS485 on the Port 2	RS485	<a href="#">Setting</a>	<a href="#">Your owner cable</a>

#### Network System configuration

Series	CPU	Link Module	Connect Type	Parameter	Cable
XINJE XD	XD5/XDM/XDC/XD5E/XL5/ XL5E/XLME	CPU Direct	Ethernet	<a href="#">Setting</a>	<a href="#">Your owner cable</a>

## ◎ Serial Communication Setting

### XINJE XC Series protocol

#### HMI Setting

Default communication: 19200, 8, even, 1; station: 1

HMI Attribute		Serial Port 0 Setting	
Type	RS232	PLC Communication Time Out	6
Baud Rate	19200	Protocol Time Out 1(ms)	3
Data Bit	8	Protocol Time Out 2(ms)	3
Parity	even	Max interval of block pack(WORDS)	16
Stop Bit	1	Max interval of block pack(BITS)	128
Slave No.	1	Max block package size(WORDS)	48
		Max block package size(BITS)	256

Use Default Setting

OK Cancel

### XINJE XDM Series protocol

#### HMI Setting

Default communication: 19200, 8, even, 1; station: 1

#### RS232

HMI Attribute		Serial Port 0 Setting	
Type	RS232	PLC Communication Time Out	6
Baud Rate	19200	Protocol Time Out 1(ms)	3
Data Bit	8	Protocol Time Out 2(ms)	3
Parity	even	Max interval of block pack(WORDS)	16
Stop Bit	1	Max interval of block pack(BITS)	128
Slave No.	1	Max block package size(WORDS)	48
		Max block package size(BITS)	256

Use Default Setting

OK Cancel

#### RS485

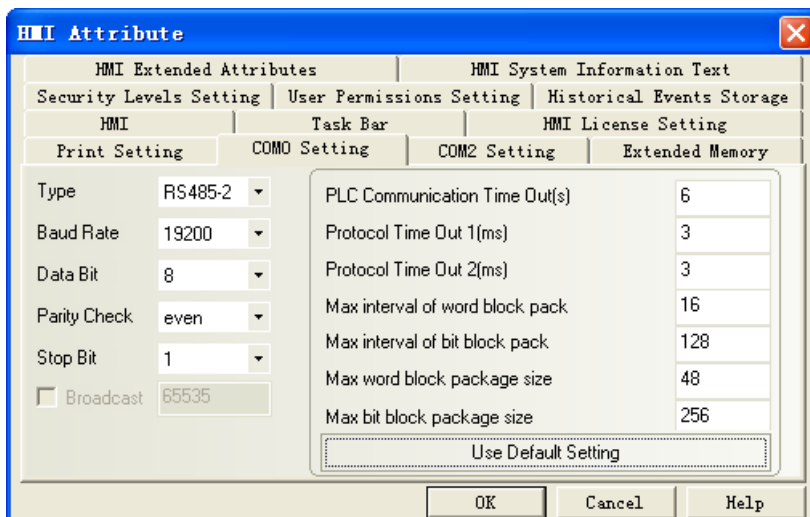

## ◎ Network Communication Setting

### XINJE XD Series(TCP Slave) protocol

#### HMI Setting

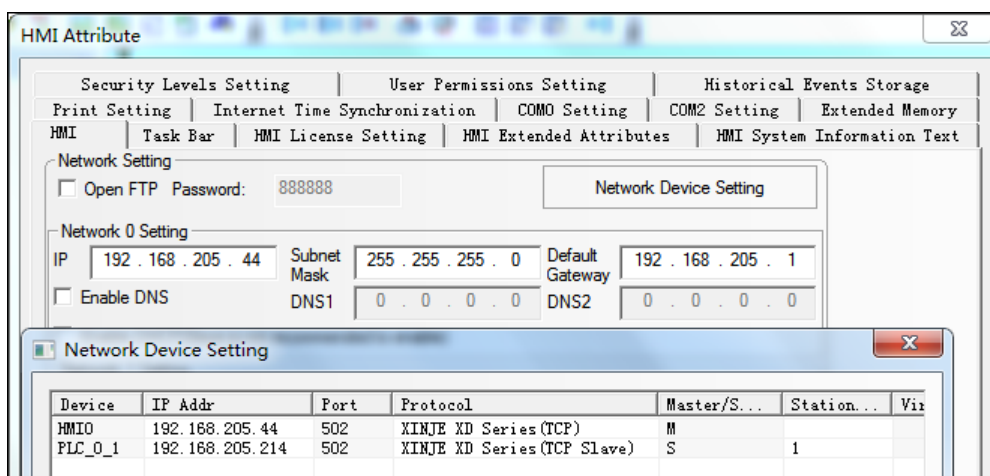
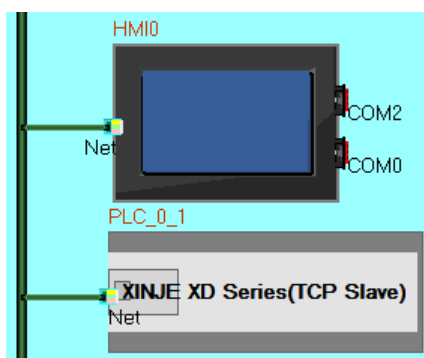

#### PLC configuration

1. Open the Xinjie XNetConfig Tool , and then select PLC
2. Connection protocol selects: XNet, finding port selects: AutoTry, check the ID search, enter the ID on the PLC machine (eg: 292-080-047-DC2E-1617), and then click Find Device
3. After clicking Find Device, the plc configuration will pop up. The following two configurations will appear:
  - 1) If you choose to obtain the IP address automatically, click the Read button at the bottom.
  - 2) If you choose to use the following IP address, enter your own IP address, and then click on the write button at the

bottom to complete the connection with plc

4. Finally open the Xinjie PLC programming tool software, click on the configuration software communication, you can directly use the specified address, enter the previously set IP address, click the OK button

## © Supported Device

### XINJE XC Series

Device	Bit Address	Word Address	Format	Notes
Internal Relay	M 0~7999	-----	DDDDD	
	M8 0-767	----	DDD	
Input Relay	X 0.0~30323.7	-----	OOOOOO.O	
Output Relay	Y 0.0~30323.7	-----	OOOOOO.O	
State Relay	S 0~99999	-----	DDDDD	
Special Relay	M 8000~99999	-----	DDDDD	
Timer Relay	T 0~99999	-----	DDDDD	
Counter Relay	C 0~99999	-----	DDDDD	
Data register	-----	D 0~7999	DDDDD	
Timer	-----	TD 0~9999	DDDDD	
Counter	-----	CD 0~9999	DDDDD	
Special Data Register	-----	D 8000~9999	DDDDD	
	-----	D8 0-1023		
FlashROM Register	-----	FD0~FD5000	DDDDD	
		FD8 0-1023	DDDD	
Special FlashROM Register	-----	FD8000~FD 9999	DDDDD	
Internal extend register	-----	ED 0~36863	DDDDD	
Input register	-----	ID 0~9999	DDDD	
Output Register	-----	QD 0~9999	DDDD	

#### NOTE:

1. **O** indicates **OCT**, **D** indicates **HEX**.
2. Example: X\Y address: 1 in the controller corresponds with 0.1 in the HMIWare; X\Y address: 17 in the controller correspond with 1.7 in the HMIWare.

### MODBUS RTU protocol

Register address in programmable controller correspond with address in modbus protocol, as follows:

#### Coil Area:

bits Addr	MODBUS addr (Decimal K)
M0~M7999	0X 1~0X 8000
X0~X511	0X 16385~0X 16714
Y0~Y511	0X 18433~0X 18762
S0~S1023	0X 20481~0X 21504
M8000~M8511	0X 24577~0X 25088

T0~T618	0X 25601~0X 26219
C0~C634	0X 27649~0X 28283

**Register Area:**

words Addr	MODBUS addr (Decimal K)
D0~D7999	4X 1~4X8000
TD0~TD618	4X 12289~4X12907
CD0~CD634	4X 14337~4X 14971
D8000~D8511	4X 16385~4X 16896
FD0~FD1535	4X 18433~4X19968
FD8000~FD8511	4X 26625~4X 27136

**XINJE XDM Series**

Device	Bit Address	Word Address	Format	Notes
Counter	HSC 0-39	-----	DD	
Counter	HC 0-1023	-----	DDDD	
Timer task	HT 0-1023	-----	DDDD	
State relay	HS 0-999	-----	DDD	
Auxiliary relay	HM 0-6143	-----	DDDD	
Order function block	SEM 0-127	-----	DDD	
Timer task	ET 0-39	-----	DD	
Counter	C 0-4095	-----	DDDD	
Timer task	T 0-4095	-----	DDDD	
Auxiliary relay	SM 0-4095	-----	DDDD	
State relay	S 0-7999	-----	DDDD	
Output relay	Y3 0-77	-----	OO	
Output relay	Y2 0-277	-----	OOO	
Output relay	Y1 0-1777	-----	OOOO	
Output relay	Y 0-77	-----	OO	
Input relay	X3 0-77	-----	OO	
Input relay	X2 0-277	-----	OOO	
Input relay	X1 0-1777	-----	OOOO	
Input relay	X 0-77	-----	OO	
Auxiliary relay	M 0-20479	-----	DDDDD	
Confidentiality register	-----	FS 0-47	DD	
Flash register	-----	SFD 0-4095	DDDD	

Flash register	-----	FD 0-8191	DDDD	
Counter	-----	HSCD 0-39	DD	
Counter	-----	HCD 0-1023	DDDD	
Timer task	-----	HTD 0-1023	DDDD	
Dater register	-----	HSD 0-1023	DDDD	
Dater register	-----	HD 0-6143	DDDDD	
Counter	-----	ETD 0-39	DD	
Timer task	-----	CD 0-4095	DDDD	
Timer task	-----	TD 0-4095	DDDD	
Dater register	-----	SD 0-4095	DDDD	
Functional module	-----	QD3 0-99	DD	
Functional module	-----	QD2 0-299	DDD	
Functional module	-----	QD1 0-1599	DDDD	
Functional module	-----	QD 0-99	DD	
Functional module	-----	ID3 0-99	DD	
Functional module	-----	ID2 0-299	DDD	
Functional module	-----	ID1 0-1599	DDDD	
Functional module	-----	ID 0-99	DD	
Dater register	-----	D 0-20479	DDDDD	

#### XINJE XD Series (TCP Slave)

Device	Bit Address	Word Address	Format	Notes
Internal relay node	M 0~20479	-----	DDDDD	
Input relay node	X 0~77	-----	OO	
Input relay node	X1 0~1777	-----	O000	
Input relay node	X2 0~277	-----	OOO	
Input relay node	X3 0~77	-----	OO	
Output relay node	Y 0~77	-----	OO	
Output relay node	Y1 0~1777	-----	O000	
Output relay node	Y2 0~277	-----	OOO	
Output relay node	Y3 0~77	-----	OO	
State node	S 0~7999	-----	DDDD	
HSC register	HSC0~39	-----	DD	
Timer node	T 0~4095	-----	DDDD	
Counter node	C 0~4095	-----	DDDD	

HC register	HC0~1023	-----	DDDD	
HT register	HT0~1023	-----	DDDD	
HS register	HS0~999	-----	DDD	
SEM register	SEM0~127	-----	DDD	
ET register	ET0~39	-----	DD	
SM register	SM0~4095	-----	DDDD	
HM register	HM0~6143	-----	DDDD	
Data register	-----	D 0~20479	DDDDD	
Timer	-----	TD 0~4095	DDDD	
Counter	-----	CD 0~4095	DDDD	
FlashROM register	-----	FD 0~8191	DDDD	
Internal extension register	-----	ED 0~36863	DDDDD	
Input register	-----	ID 0~30099	DDDDD	
Output register	-----	QD 0~30099	DDDDD	
FS register	-----	FS0~47	DD	
SFD register	-----	SFD0~4095	DDDD	
HSCD register	-----	HSCD0~39	DD	
HCD register	-----	HCD0~1023	DDDD	
HTD register	-----	HTD0~1023	DDDD	
HSD register	-----	HSD0~1023	DDDD	
HD register	-----	HD0~6143	DDDD	
ETD register	-----	ETD0~39	DD	
SD register	-----	SD0~4095	DDDD	

## © Cable Diagram

### RS232 Communication

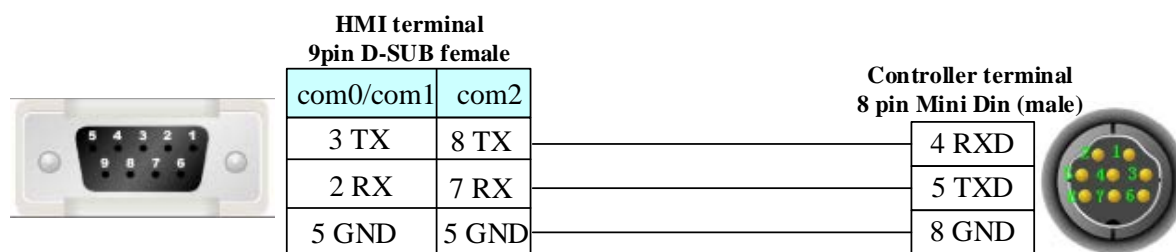

### RS485 Communication



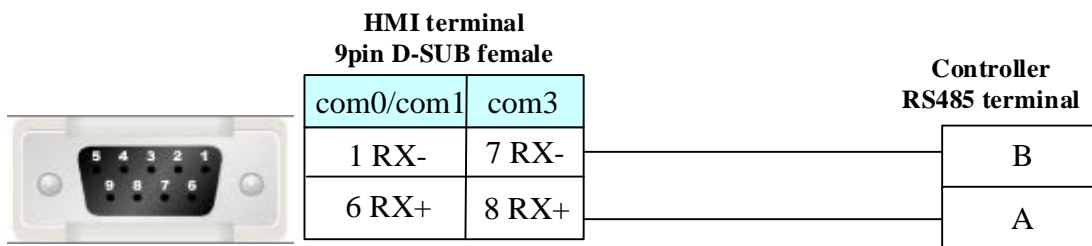

### Ethernet communication protocol cable

Cross-connection or crossover network cable can be used as communication cable via the hub  
Refer to [3.3 Download by Network Ethernet](#) for method of making connection cable.

## 4.85 XiLin Inverter

### Serial Communication

Series	CPU	Link Module	Driver
XiLin	EH600	RS485 on the CPU unit	XiLin EH600

### System configuration

Series	CPU	Link Module	COM Type	Parameter	Cable
XiLin	EH600	RS485 on the CPU unit	RS485	<a href="#">Setting</a>	<a href="#">Your owner cable</a>

### Communication Setting

#### HMI Setting

Default Communication: 9600, 8, even, 1; station: 1

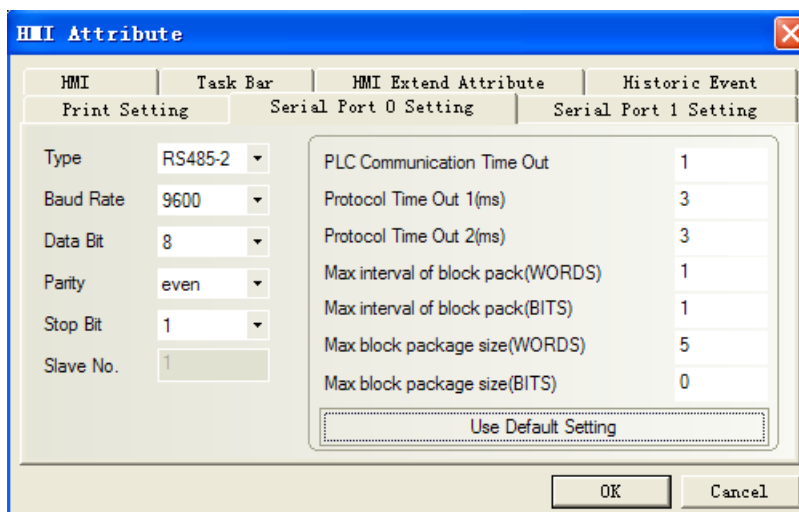

### Supported Device

Device	Bit Address	Word Address	Format	Notes
--------	-------------	--------------	--------	-------

Addr communication parameter	-----	Addr	HHHH	
A FWD	-----	A 0	D	
B REV	-----	B 0	D	
C FJOG	-----	C 0	D	
D RJOG	-----	D 0	D	
E Free halt	-----	E 0	D	
F Slow down	-----	F 0	D	
G Reset failures	-----	G 0	D	

**PLC Setting**

Please refer to XILIN frequency converter manual for details about device address.

**◎ Cable Diagram**

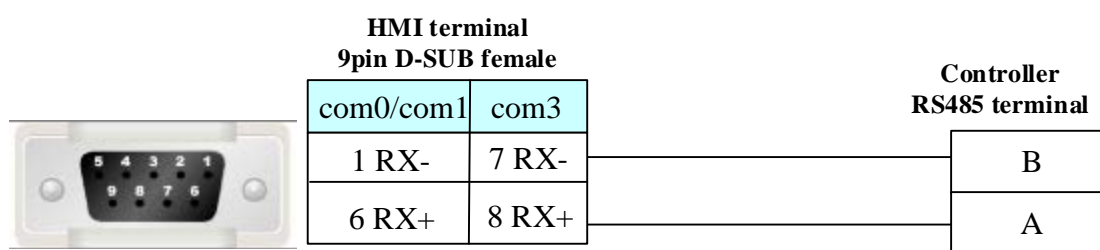

**4.86 Yamatake Corporation**

**◎ Serial Communication**

Series	CPU	Link Module	Driver
DCP30	P30A□□□□□□2□□	RS485 on the CPU unit	Yamatake DCP30
SDC35/36	C35□□□□□□2□□	RS485 on the CPU unit	Yamatake SDC/DMC
	C35□□□□□□4□□		
	C36□□□□□□2□□		
	C36□□□□□□4□□		
DMC	DMC10D□□□□□□□□	RS485 on the CPU unit	
	DMC10S□□□□□□□□		

**◎ System configuration**

Series	CPU	Link Module	COMM Type	Parameter	Cable
DCP30	P30A□□□□□□2□□	RS485 on the CPU unit	RS485	<a href="#">Setting</a>	<a href="#">Your owner cable</a>
SDC35/36	C35□□□□□□2□□	RS485 on the CPU unit	RS485	<a href="#">Setting</a>	<a href="#">Your owner cable</a>
	C35□□□□□□4□□				
	C36□□□□□□2□□				
	C36□□□□□□4□□				
DMC	DMC10D□□□□□□□□	RS485 on the CPU	RS485	<a href="#">Setting</a>	<a href="#">Your owner</a>

	DMC10S□□□□□□□□	unit			<a href="#">cable</a>
--	----------------	------	--	--	-----------------------

## ◎ Communication Setting

### HMI Setting

#### Yamatake DCP30 protocol

Default communication: 9600, 8, even, 1; station: 1

#### Yamatake SDC/DMC protocol

### SDC

Default communication: 9600, 8, none, 1; station: 1

### DMC

Default communication: 19200, 8, even, 1; station: 6

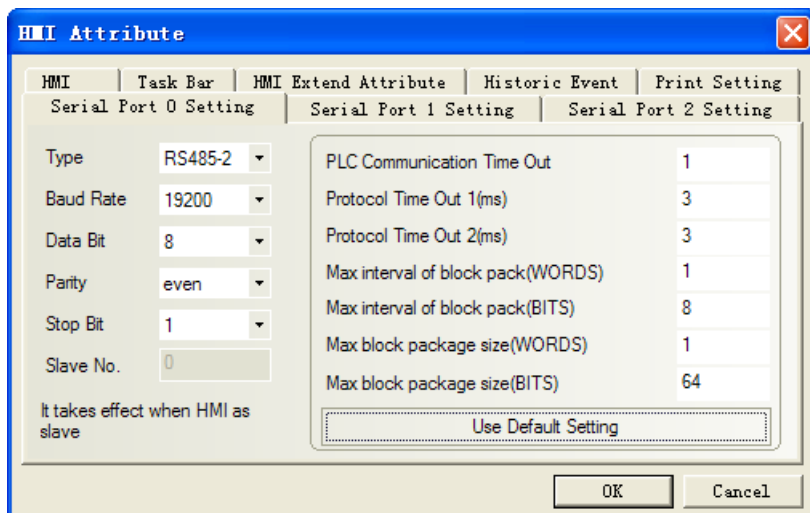

### PLC Setting

1. Set modbus RTU in the SLP-D10, and then download.

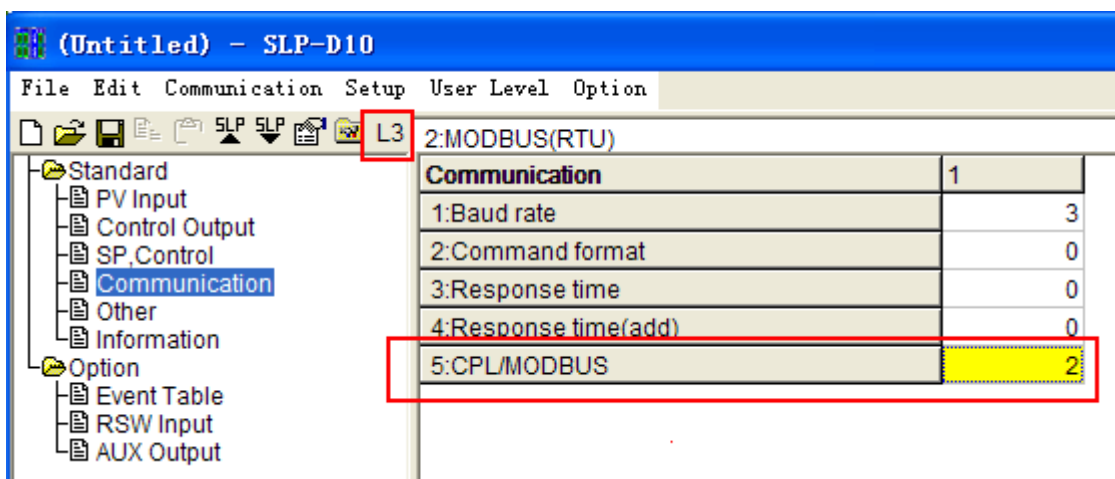

2. Station match with the switch on the device.

### ◎ Supported Device

#### DCP30

Device	Bit Address	Word Address ( Parameter code )	Format	Notes
RUN Status	-----	1-26	DDD	
PARA	-----	1-33	DDD	
EU	-----	1-13	DDD	
PID	-----	1-80	DDD	
SET	-----	1-99	DDD	
TBL	-----	1-22	DDD	
CNST	-----	1-26	DDD	
FO_R	1-19	-----	DDD	
FO_W	1-19	-----	DDD	
FC	1-19	-----	DDD	
FD	1-19	-----	DDD	
FBR1_R	-----	1.0-30.22	DDD.DD	

FBR2_R	-----	1.0-30.22	DDD.DD	
FBR3_R	-----	1.0-30.22	DDD.DD	
FBR4_R	-----	1.0-30.22	DDD.DD	
FBR5_R	-----	1.0-30.22	DDD.DD	
FBR6_R	-----	1.0-30.22	DDD.DD	
FBR7_R	-----	1.0-30.22	DDD.DD	
FBR8_R	-----	1.0-30.22	DDD.DD	
FBR9_R	-----	1.0-30.22	DDD.DD	
FBR10_R	-----	1.0-30.22	DDD.DD	
FBR11_R	-----	1.0-30.22	DDD.DD	
FBR12_R	-----	1.0-30.22	DDD.DD	
FBR13_R	-----	1.0-30.22	DDD.DD	
FBR14_R	-----	1.0-30.22	DDD.DD	
FBR15_R	-----	1.0-30.22	DDD.DD	
FBR16_R	-----	1.0-30.22	DDD.DD	
FBR17_R	-----	1.0-30.22	DDD.DD	
FBR18_R	-----	1.0-30.22	DDD.DD	
FBR19_R	-----	1.0-30.22	DDD.DD	

Please refer to the communication protocol for details.

**NOTE:**

1、SET C85 ----- Transmission rate, data type

0: 9600, even, stopbit 1;

1: 9600, none, stopbit 2;

2: 4800, even, stopbit 1;

3: 4800, none, stopbit 2.

2、SET C84 -----setting station No. **The value of C84 must be the same as the PLC's station No.**

When connecting multiple instruments, for distinguishing instruments, each instrument must be set C84 value with a different parameter. .

3、Must press "FUNC+PARA" to set the parameter;

4、PROG. have **19 numbers** and SEG have **30 numbers**, press DOWN key (sub) and PROG key (add) to change program number;

5、Press "FUNC+PROG" to change the program.----every program must be set firstly and then communicate will be ok, or else "PLC Response Error" will print;

6、After "RUN/HLD" light on, many parameters can't be modified(e.g. SET) In order to reset, press " PROG+RUN/HOLD" .

Modify the parameter at the state of "DISP", not at the state of "INPUT";

7、On the temperature controller, time parameters show number with sexagesimal.

( Example it shows 2222 on the screen, but on the controller panel shows  $37.02 \times 60 + 2 = 2222$  )

8、PROG's address setting:

FBR1\_R indicates prog 1. (e.g. PROG 1) format: DDD.DD. Main address DDD indicates seg No, subaddress DD indicates parameter value, the correspondence as follows

( Example: FBR1\_R address 11.10 indicates PROG 1,SEG 1,T1 2nd )

**Sub addr DD correspond to temperature controller:**

Sub Addr	Parameter	Sub Addr	Parameter
.0	SP	.12	T2 2nd
.1	TM	.13	T3 1st
.2	None (Skip)	.14	T3 2nd
.3	EV1	.15	T4 1st
.4	Blank	.16	T4 2nd
.5	EV2	.17	T5 1st
.6	Blank	.18	T5 2nd
.7	EV3	.19	PID
.8	Blank	.20	None (Skip)
.9	T1 1st	.21	9.5.
.10	T1 2nd	.22	9.5.to
.11	T2 1st		

**SDC36 (Please refer to the manual of yamatake SDC36 for details)**

Device	Bit Address	Word Address	Format	Notes
Data Register	-----	4X 0-65535	DDDDD	

**DMC (Please refer to the manual of DMC-SPL for details, in 10-8 communication parameters)**

Device	Bit Address	Word Address	Format	Notes
Data Register	-----	4X 1002-65535	DDDDD	Address add 1 to the list of communication parameters

**Example:** CH1 PV is according to 4X1005 in the HMIWare.

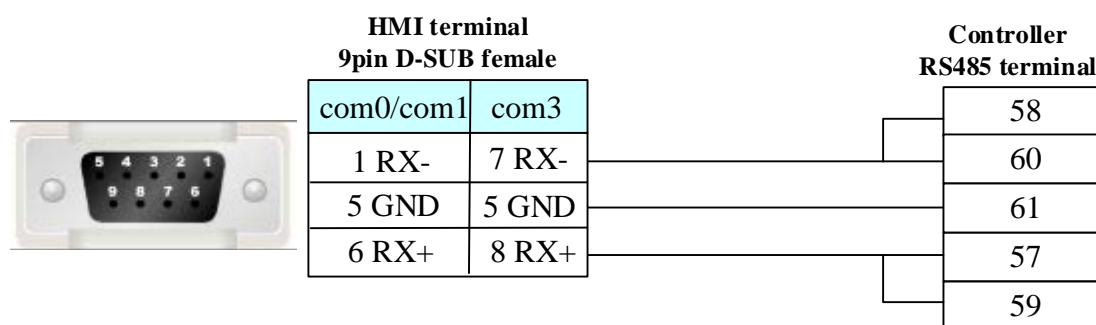
**© Cable Diagram****DCP 30 series****RS485 communication cable****RS232 communication cable**

Need to use **RS-232 to RS-422/485** converter

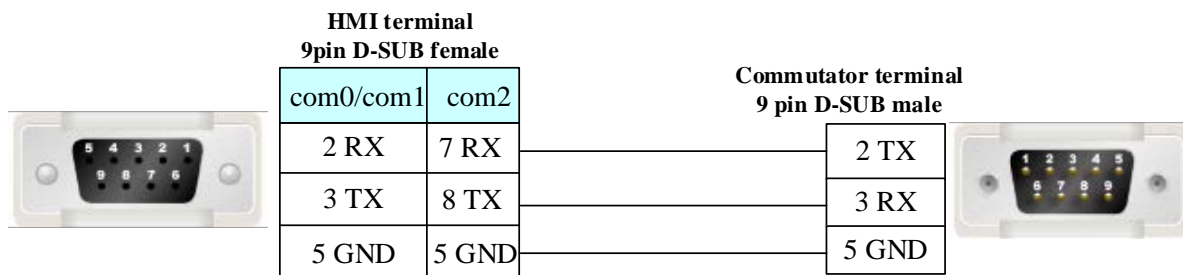

### SDC36 series

#### RS485 communication cable

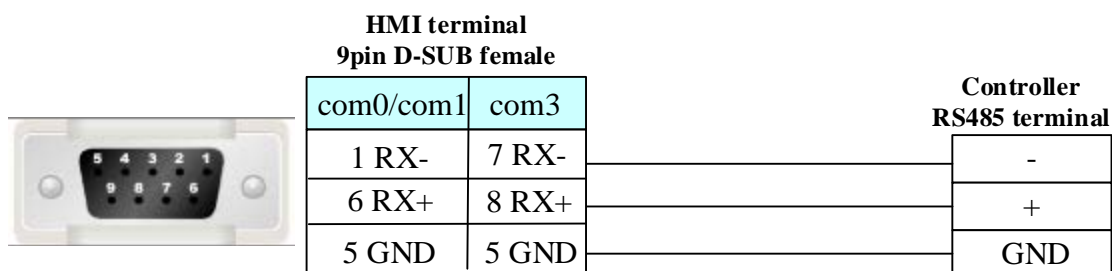

### DMC series

#### RS485 communication cable

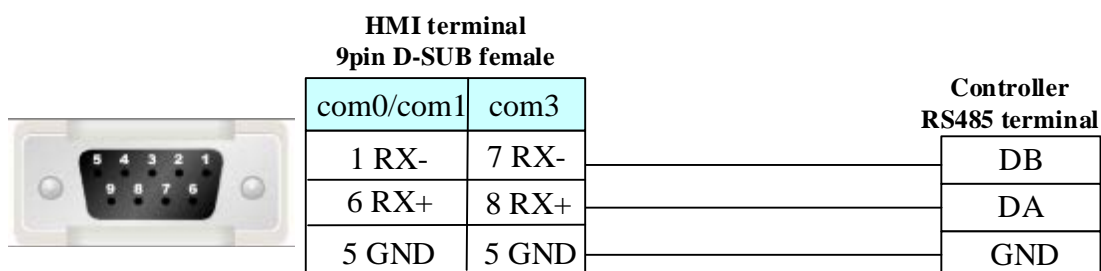

## 4.87 Yaskawa Electric Corporation

### ◎ Serial Communication

Series	CPU	Link Module	Driver
V (Inverter)	CIMR-JT2 A0001BA A	RS485 on the CPU unit	Yaskawa AH Modbus RTU
MP (Motion Controller)	MP2200 MP2300 MP2310 MP2300S	RS232 on the CPU unit	Yaskawa MP2300
ΣII /ΣII Plus(Servo Controller)	SGDM	RS232 on the CPU unit RS422 on the CPU unit	Yaskawa SGDM

	SGDV	RS232 on the CPU unit	Yaskawa SGD <sub>V</sub>
		RS422 on the CPU unit	

◎ **Network communication** (support indirect online and direct online)

Series	CPU	Link Module	Driver
MP series	MP2400	ETH on the CPU unit	Yaskawa Ethernet(UDP Slave)

◎ **Serial System configuration**

Series	CPU	Link Module	COM Type	Parameter	Cable
V	CIMR-JT2A00 01BAA	RS485 on the CPU unit	RS485	<a href="#">Setting</a>	<a href="#">Your owner cable</a>
MP	MP2300	RS232 on the CPU unit	RS232	<a href="#">Setting</a>	<a href="#">Your owner cable</a>
Σ II / Σ II Plus	SGDM	RS232 on the CPU unit	RS232	<a href="#">Setting</a>	<a href="#">Your owner cable</a>
		RS422 on the CPU unit	RS422	<a href="#">Setting</a>	<a href="#">Your owner cable</a>
	SGDV	RS232 on the CPU unit	RS232	<a href="#">Setting</a>	<a href="#">Your owner cable</a>
		RS422 on the CPU unit	RS422	<a href="#">Setting</a>	<a href="#">Your owner cable</a>

◎ **Network System configuration**

Series	CPU	Link Module	COMM Type	Parameter	Cable
MP series	MP2400	ETH on the CPU unit	ETH	<a href="#">Setting</a>	<a href="#">Your owner cable</a>

◎ **Serial Communication Setting**

**HMI Setting**

**Yaskawa AH Modbus RTU protocol**

Default communication: 9600, 8, even, 1; station: 1

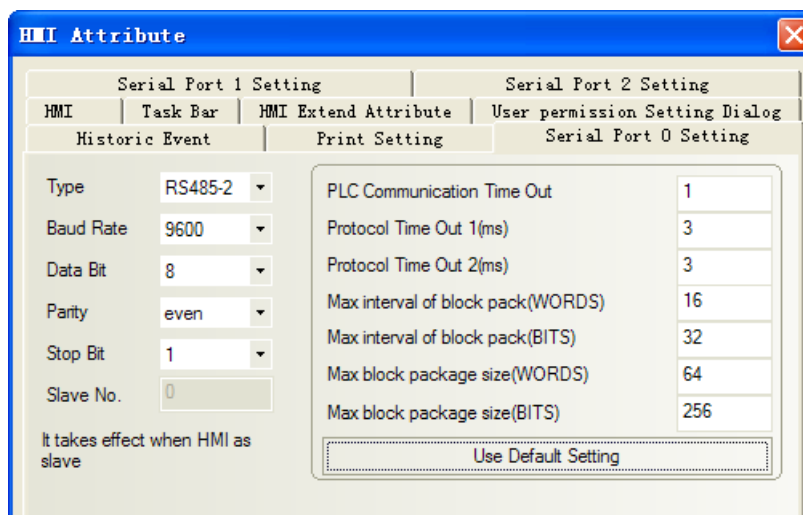

**PLC Setting**

19.0 change the inverter panel button "up" or "down", adjustment to the parameter mode

20.0 then adjust to H5-01 by the button "up" or "down", according to the required parameter set

No.	Name	Scope	Parameter description	Setting
H5-01	Secondary station	0~FFH	Secondary station	1F



	address		number	
H5-02	The choice of the communication speed	0~5	0: 1200bps 1: 2400bps 2: 4800bps 3: 9600bps 4: 19200bps 5: 38400bps	3
H5-03	The choice of the communication check	0~2	0: no check 1: even check 2: odd check	0

**NOTE:** the inverter should be restarted to be effective.

### Yaskawa MP2300 protocol

Default communication: 19200, 8, even, 1; station: 1

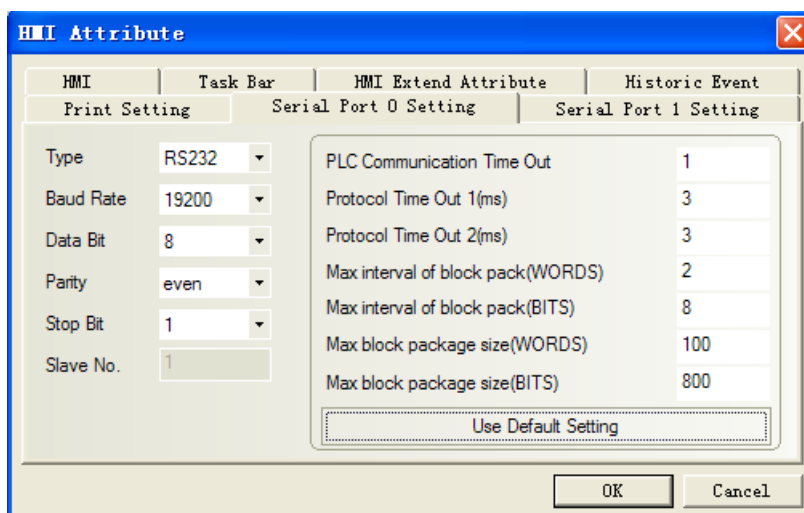

### Yaskawa SGDM protocol

Default communication: 9600, 7, even, 1; station: 0

RS232 communication

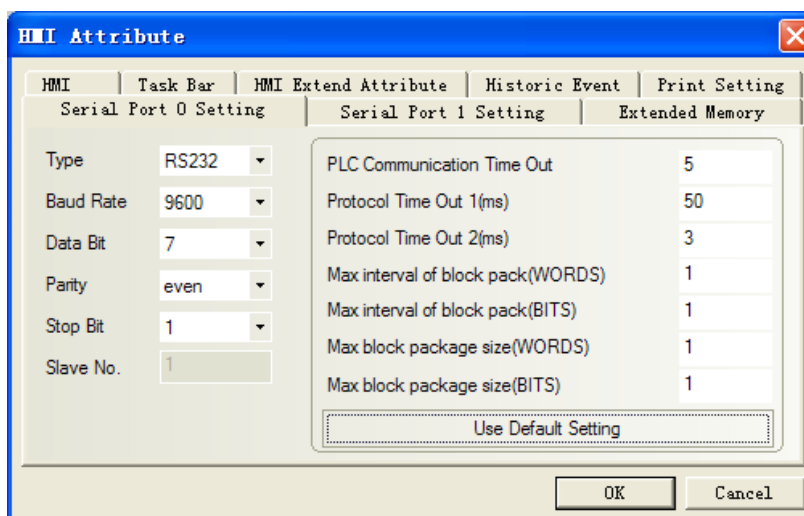

### RS422 communication

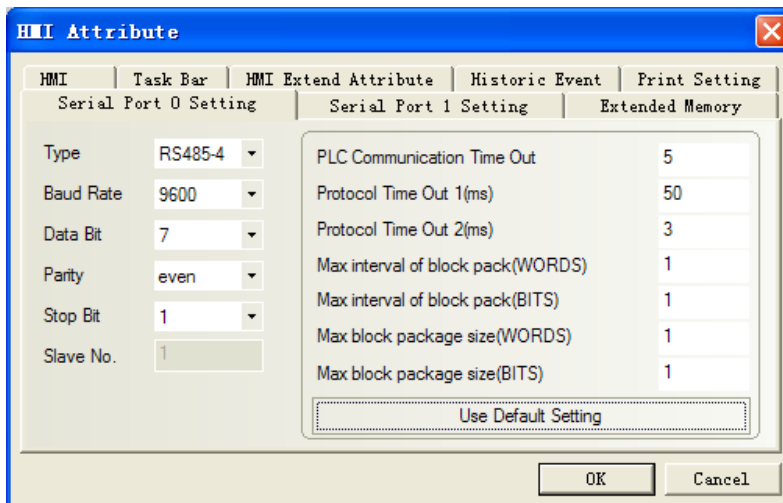

### PLC Setting

Related parameters Settings refer to the communication equipment description.

### Yaskawa SGD V protocol

#### RS232 communication

#### HMI Setting

Default communication: 19200, 8, even, 1; station: 0

**NOTE:** Set max word block package size as 2

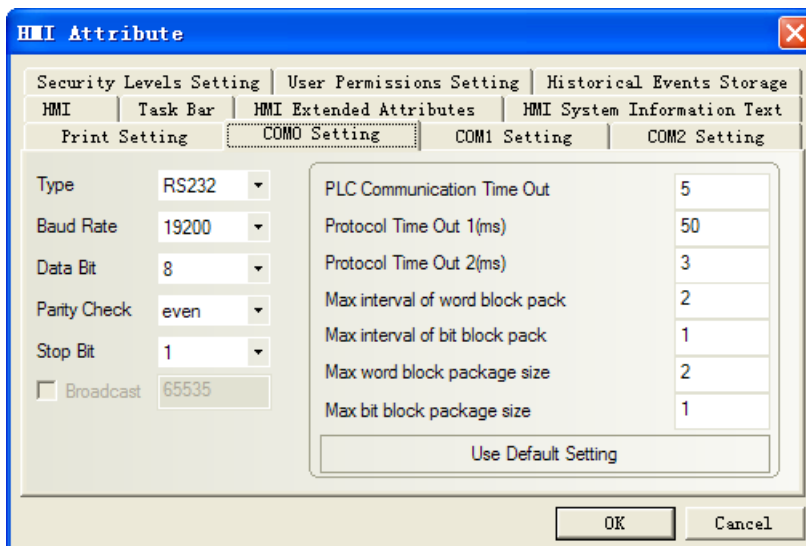

### RS422 communication

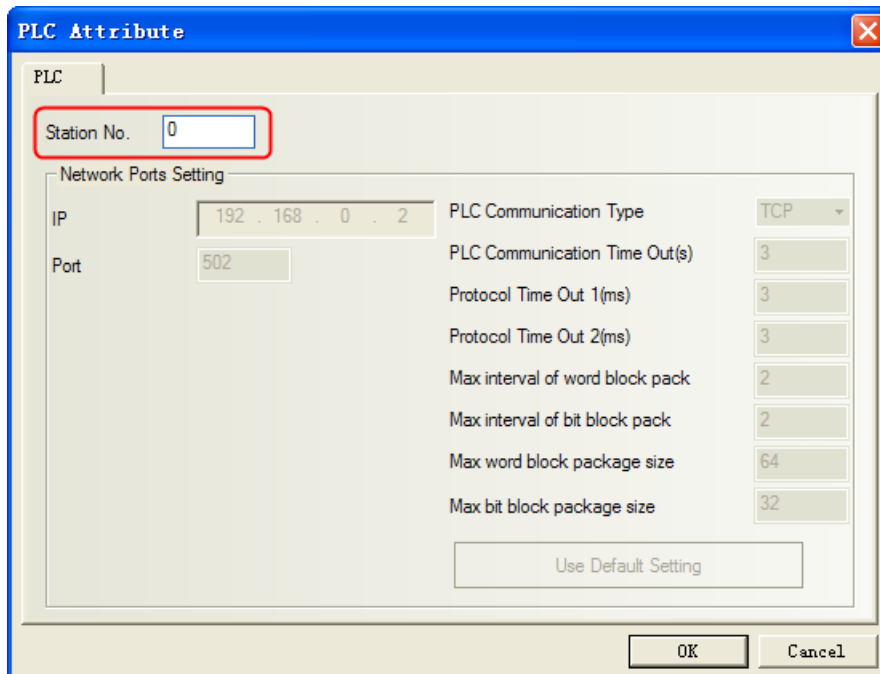
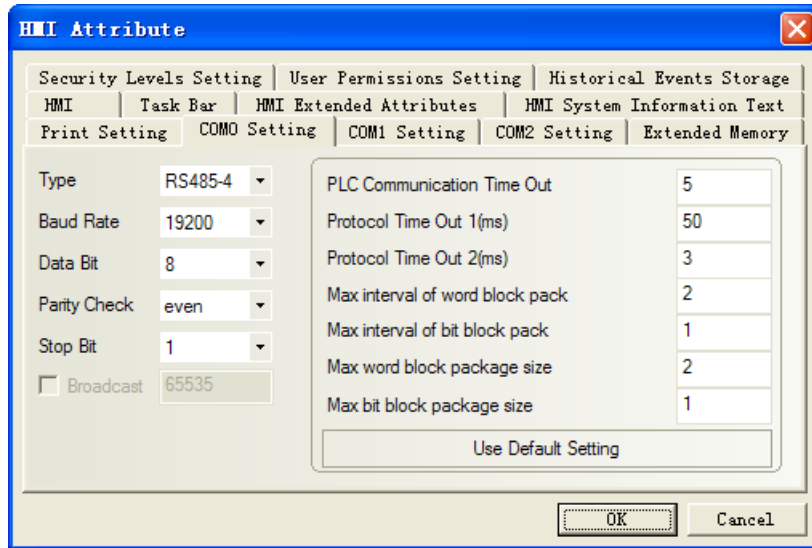

**NOTE:** Station No. is a decimal number corresponding to axis address of servo controller.

### PLC Setting

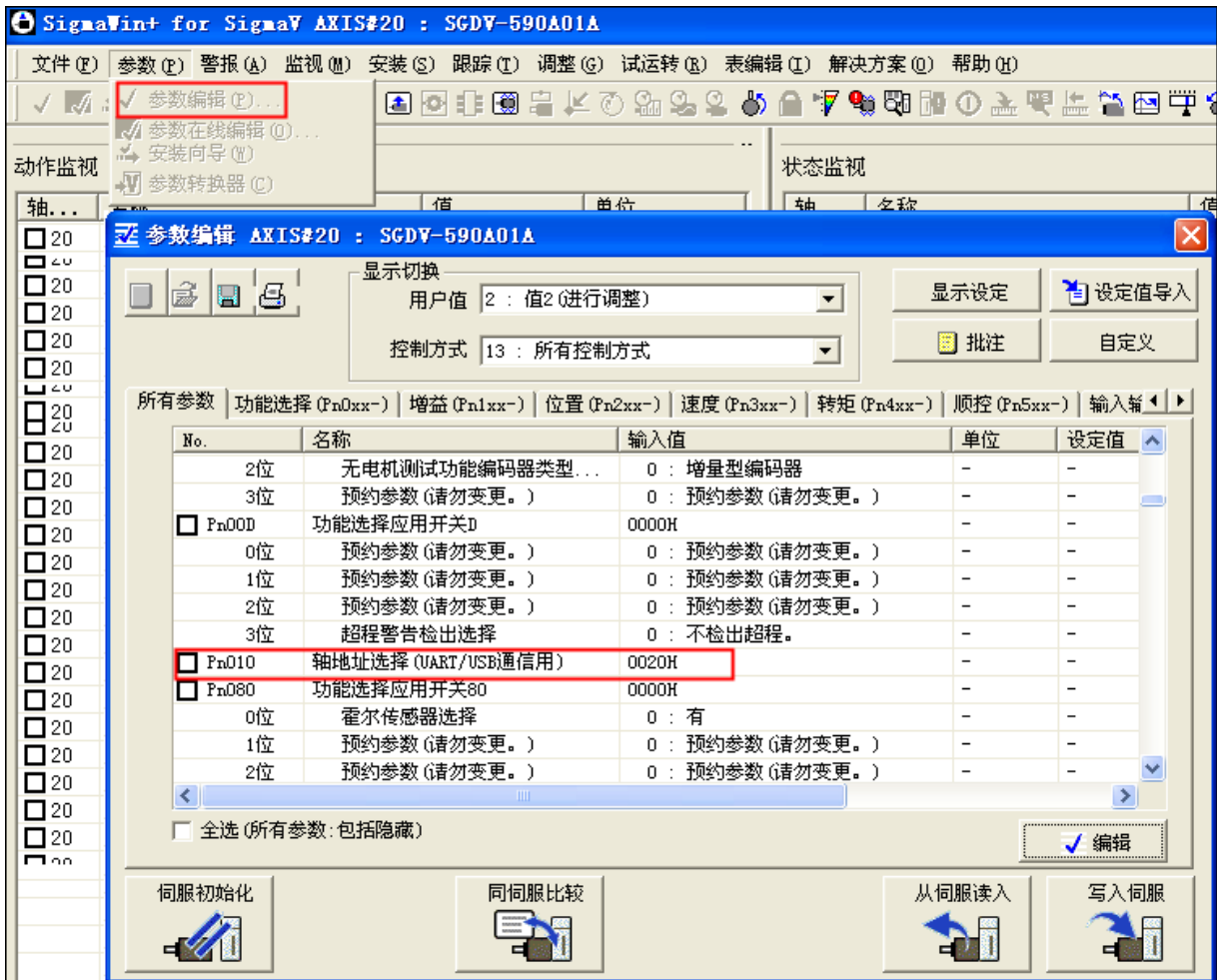
**NOTE:**

1. axis address 0020H is the station number of PLC, here is hexadecimal, HMI is the decimal system;
2. if you change the axis address, Parameters will be displayed unless you restart

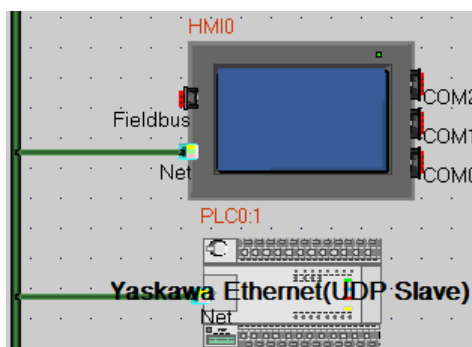
**◎ Network Communication Setting****Yaskawa Ethernet(UDP Slave) protocol****HMI Setting**

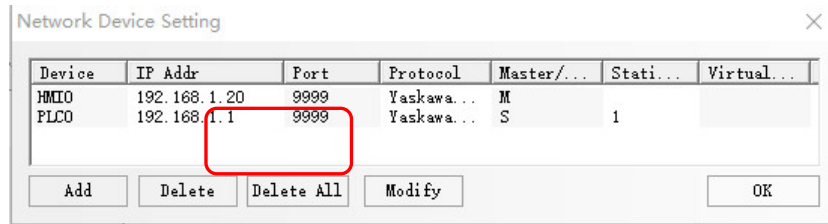

**NOTE:**The port number must be set to 9999 in HMI software otherwise hmi can not communicate with controller.

### PLC Setting

1.If you do not know the IP in MP2400, you can first put INIT and CNFG ON in SW1, then power ON the controller, and then the default IP: 192.168.1.1.



2.Open the software MPE720 ver.7 and select the model MP2400.

3.Change the IP of the computer to be the same network segment with the controller , for example: the computer IP is 192.168.1.33,then click the connection icon in the MPE software, and after the connection, control is online state.

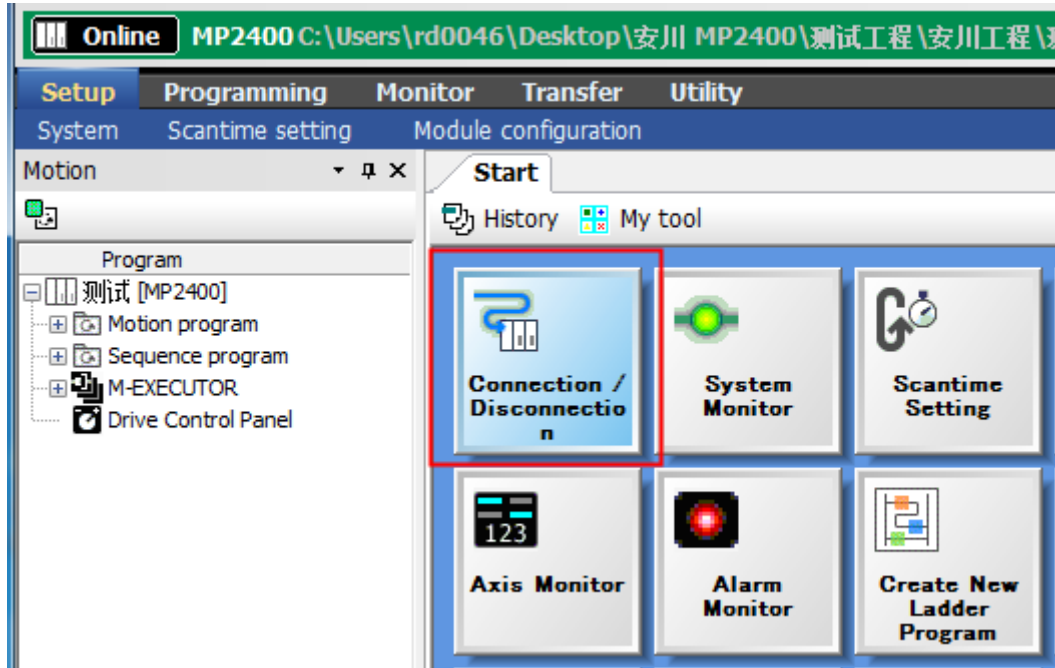

4. Click Setup, and select module configuration to set IP and connect to your device.



5. In the following window, double-click 218IFA.

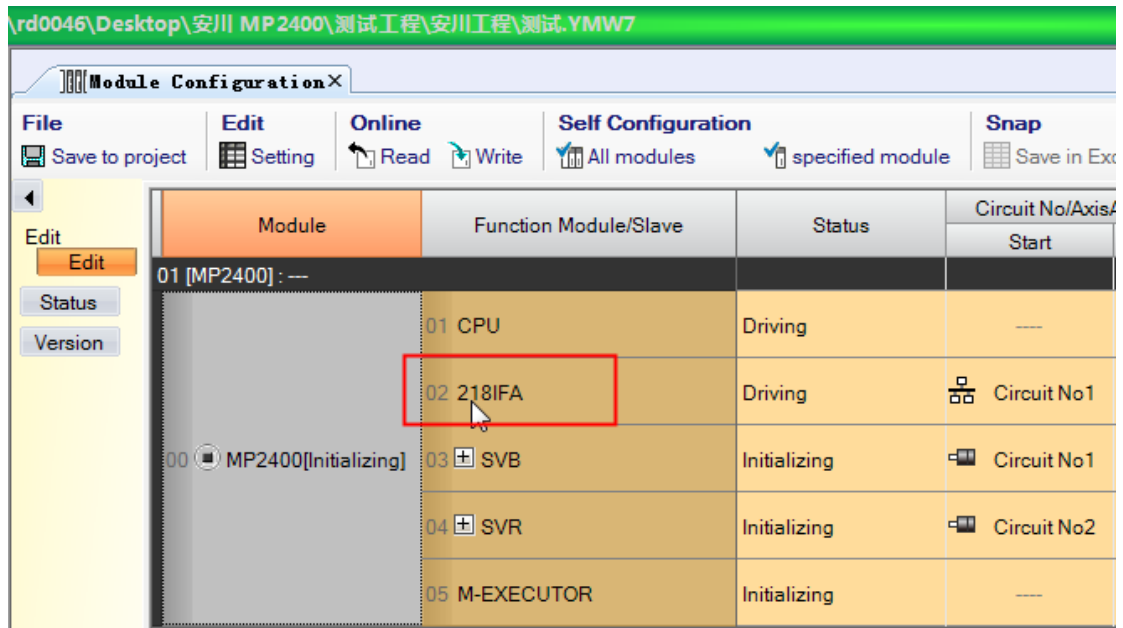

6. You can modify IP, port number and other parameters.

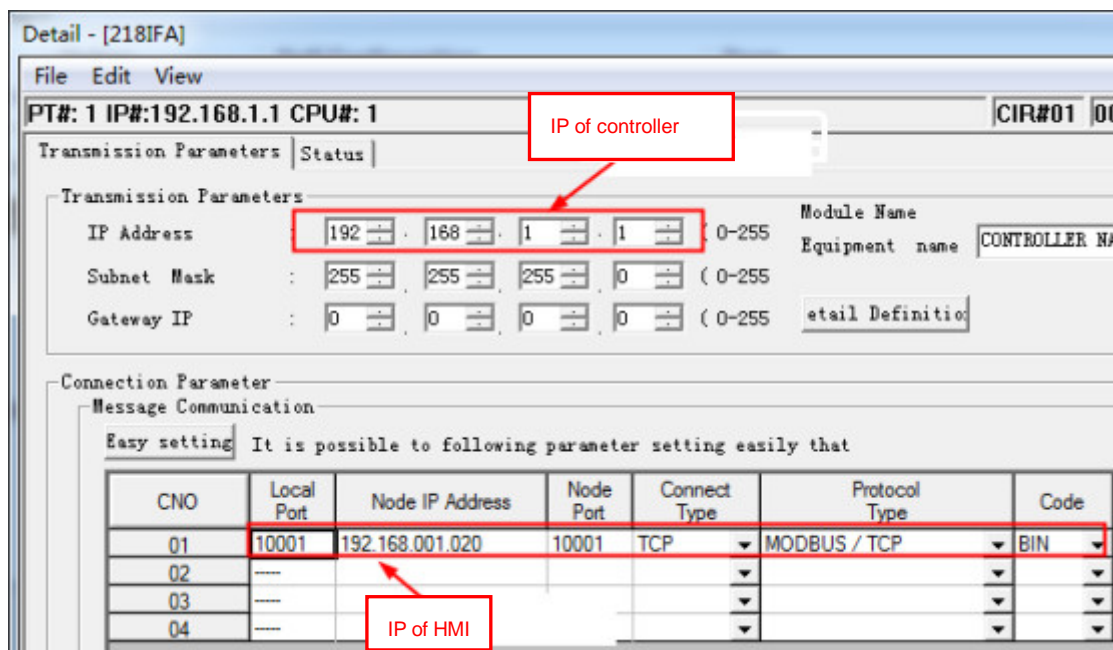

**NOTE:**

- ①. IP address of controller MP2400:192.168.1.1 port number 10001.
  - ②. HMI IP address: 192.168.1.20 port number 10001.
  - ③. Select MODBUS TCP protocol.
7. After modification, click save, and download to the controller, select online -- write into controller.



8. Pull all SW1's dials to OFF, restart the controller (parameter effected)

9. If online, then you can monitoring the data:

Monitor single data:

Watch 1		
Variable	Value	Comment
IW0000	-32768	
OW0000		

Monitor the Register:

Register List 1								
Register	MW00000							
	0	1	2	3	4	5	6	7
MW00000	-1	1212	127	0	0	0	0	0
MW00016	0	0	0	0	0	0	0	0
MW00032	0	0	0	0	0	0	0	0
MW00048	0	0	0	0	0	0	0	0
MW00064	0	0	0	0	0	0	0	0
MW00080	0	0	0	0	0	0	0	0

## ◎ Supported Device

### V inverter

Device	Bit Address	Word Address	Format	Notes
Internal/external output node	0X1-65535	-----	DDDDD	
Internal/external input node	1X1-65535	-----	DDDDD	
Simulant input data register	-----	3X1-65535	DDDDD	
data register	-----	4X1-65535	DDDDD	

#### NOTE:

- 1 this drive can not provide write batch of word part;
- 2 Address correspondence: MEMOBUS+1=4X

Eg: b1-01 (requeency instruction selection) , MEMOBUS register address is 080 H;the corresponding screen is 4X 385

### MP2300

Device	Bit Address	Word Address	Format	Notes
Coil	MB0.0-4095.F	-----	DDDD.H	
Input Relay	IB 0.0-FFF.F	-----	HHHH.H	
Hold Register	-----	MW 0-65534	DDDDD	
Input Register	-----	IW 0-7FFF	HHHH	

**NOTE:** IB0.0-0.F are occupied by the system; IW0 is occupied by the system.

### SGDM

Device	Bit Address	Word Address	Format	Notes
Function Selection Basic Switches	-----	Pn000 ~ Pn003	HHH	
Speed Loop Gain and so on	-----	Pn100 ~ Pn118	HHH	
Position Control Reference	-----	Pn200 ~ Pn205	HHH	
Speed Control Reference	-----	Pn300 ~ Pn308	HHH	
Torque Control Reference	-----	Pn400 ~ Pn407	HHH	
Sequence Reference	-----	Pn500 ~ Pn510	HHH	
Other	-----	Pn600 ~ Pn601	HHH	
Monitor mode	-----	Un000 ~ Un00D	HHH	



**SGDV**

Device	Bit Address	Word Address	Format
Function Selection	-----	( Pn000~Pn002 ) & ( Pn006~Pn009 ) ( Pn00B~Pn00D ) & Pn010 & Pn080	HHH
Gain	-----	( Pn100~Pn106 ) & ( Pn109~Pn10F ) & Pn11F ( Pn121~Pn125 ) & ( Pn131~Pn132 ) & ( Pn135~Pn136 ) ( Pn139 & Pn13D ) & ( Pn140~Pn14B ) Pn14F & ( Pn160~Pn165 ) & Pn170 & Pn190	HHH
Position	-----	Pn200 & Pn205 & Pn207 & Pn20A & Pn20E Pn210 & Pn212 & ( Pn216~Pn218 ) & Pn22A & Pn281	HHH
Speed	-----	( Pn300~Pn307 ) & ( Pn310~Pn312 ) & Pn324	HHH
Touque	-----	( Pn400~Pn410 ) & Pn412 & Pn415 & ( Pn423~Pn425 ) Pn456 & Pn460 & ( Pn481~Pn482 ) & ( Pn486~Pn488 ) Pn490 & ( Pn493~Pn495 ) & Pn498	HHH
Sequential Control	-----	( Pn501~Pn503 ) & ( Pn506~Pn509 ) & Pn51B Pn51E & Pn520 & Pn522 & Pn524 & Pn526 ( Pn528~Pn52C ) & ( Pn52F~Pn531 ) & ( Pn533~Pn536 ) ( Pn550~Pn553 ) & ( Pn560~Pn561 ) & ( Pn600~Pn601 )	HHH
Input/Output signal	-----	( Pn50A~Pn513 ) & ( Pn515~Pn517 )	HHH

**UDP**

Device	Bit Address	Word Address	Format	Notes
Input register node	IB0000.0-FFFF.F	-----	HHHHH.H	
Output register node	OB0000.0-FFFF.F	-----	HHHHH.H	
holding register node	MB00000.0-65534.F	-----	DDDDD.H	
	SB 0.0-8198.F	-----	DDDD.H	
Input register	-----	IW0000-FFFF	HHHH	
Output register	-----	OW0000-FFFF	HHHH	
Holding register	-----	MW00000-65534	DDDDD	
	-----	SW 0-65535	DDDDD	

**NOTE:** In the HMIWare, bit address format is HHHH.H, but there is no point in the controller. E.g.: In the EV5000 software, the bit address is MB65534.F, but there is no point in the controller, and it is MB65534F. We set the I\O address as large as enough, and we found the big address can't be written, but it is the same effect with the monitoring.

**© Cable Diagram****V series inverter****RS485 communication cable**

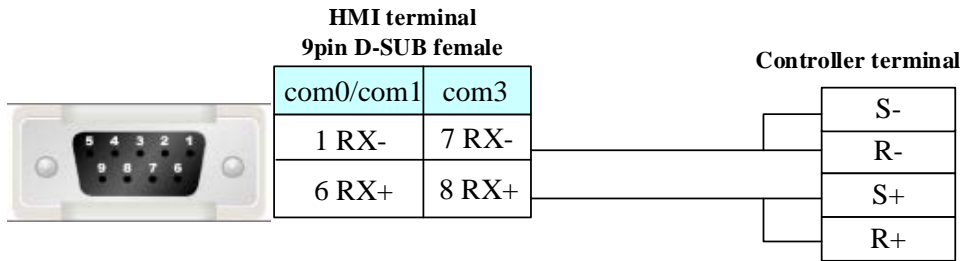

**MP2300**

**RS232 communication cable**

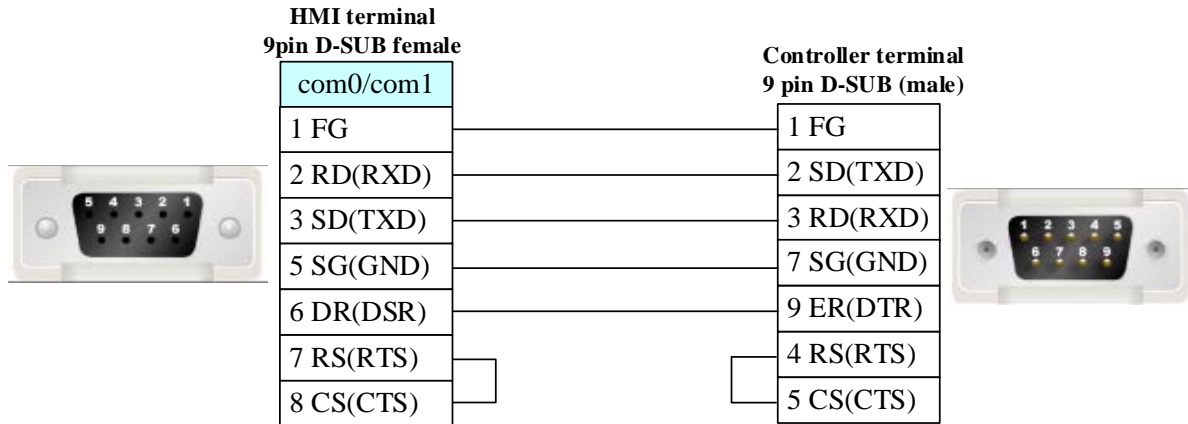

**SGDM/SGDV**

**RS232 communication cable**

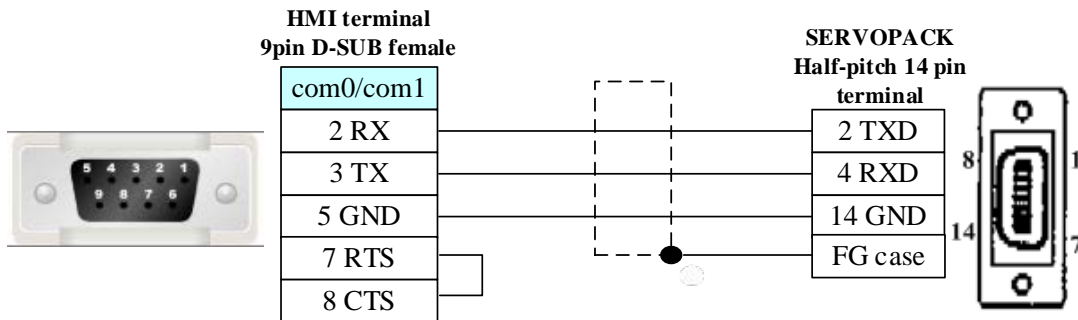

**RS422 communication cable**

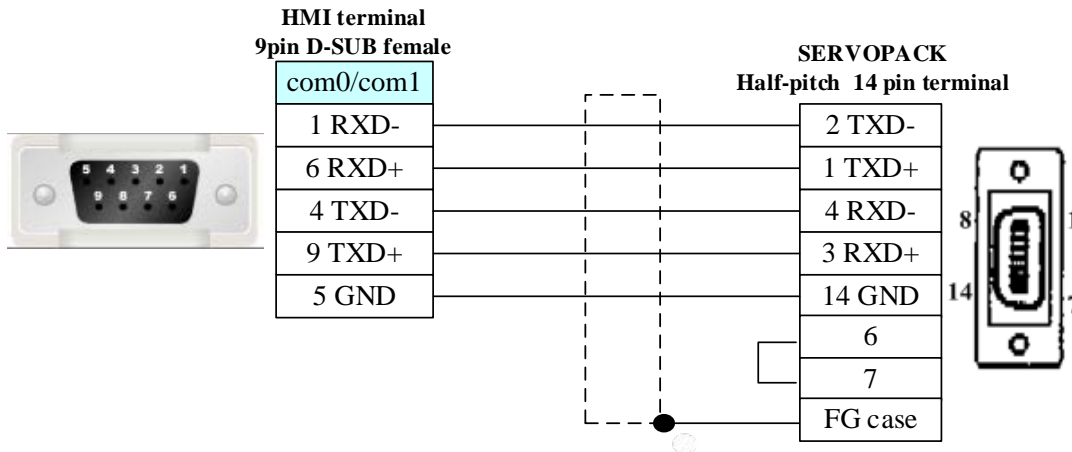

**Ethernet communication protocol cable**

Cross-connection or crossover network cable can be used as communication cable via the hub

Refer to [3.3 Download by Network Ethernet](#) for method of making connection cable.

## 4.88 Yokogawa Electric Corporation

### ◎ Serial Communication

Series	CPU	Link Module	Driver
FA-M3	F3SP21-0N	CPU Direct	Yokogawa FA-M3
	F3SP25-2N		
	F3SP28-3N		
	F3SP35-5N		
	F3SP38-6N		
	F3SP53-4H		
	F3SP58-6H		
	F3SP28-3S		
	F3SP38-6S		
	F3SP53-4S		
	F3SP58-6S		
	F3SP59-7S		
	F3SP20-0N	F3LC11-1N	
	F3SP21-0N	F3LC11-1F	
	F3SP25-2N	F3LC11-2F	
	F3SP28-3N	F3LC12-1F	
	F3SP30-0N	F3LC11-2N	
	F3SP35-5N		
	F3SP38-6N		
	F3SP53-4H		
	F3SP58-6H		
	F3SP36-3N		
	F3SP28-3S		
	F3SP38-6S		
F3SP53-4S			
F3SP58-6S			
F3SP59-7S			
F3SP66-4S			
F3SP67-6S			

### ◎ Network Communication (direct online simulation disable)

Series	CPU	Link Module	Driver
--------	-----	-------------	--------

FA-M3	F3SP21-0N F3SP25-2N F3SP28-3N F3SP35-5N F3SP38-6N F3SP53-4H F3LE01-5T F3LE11-0T F3SP58-6H F3SP28-3S F3SP38-6S F3SP53-4S F3SP58-6S F3SP59-7S	F3LE01-5T F3LE11-0T	Yokogawa FA-M3 Ethernet(TCP Slave)
	F3SP66-4S F3SP67-6S	Ethernet I/F on CPU Unit	

### ◎ Serial System configuration

Series	CPU	Link Module	COM Type	Parameter	Cable
FA-M3	F3SP21-0N F3SP25-2N F3SP28-3N F3SP35-5N F3SP38-6N F3SP53-4H F3SP58-6H F3SP28-3S F3SP38-6S F3SP53-4S F3SP58-6S F3SP59-7S	RS232 on the CPU unit	RS232	<a href="#">Setting</a>	<a href="#">Your owner cable</a>
	F3SP20-0N F3SP21-0N F3SP25-2N F3SP28-3N F3SP30-0N F3SP35-5N	RS422/485(4Wire) port on F3LCLL-2F	RS422	<a href="#">Setting</a>	<a href="#">Your owner cable</a>

	F3SP38-6N F3SP53-4H F3SP58-6H F3SP36-3N F3SP28-3S F3SP38-6S F3SP53-4S F3SP58-6S F3SP59-7S F3SP66-4S F3SP67-6S	RS422/485(2Wire) port on F3LCLL-2F	RS485	<a href="#">Setting</a>	<a href="#">Your owner cable</a>
--	---	---------------------------------------	-------	-------------------------	----------------------------------

### ◎ Network System configuration

Series	CPU	Link Module	Connect Type	Parameter	Cable
FA-M3	F3SP21-0N F3SP25-2N F3SP28-3N F3SP35-5N F3SP38-6N F3SP53-4H F3LE01-5T F3LE11-0T F3SP58-6H F3SP28-3S F3SP38-6S F3SP53-4S F3SP58-6S F3SP59-7S	F3LE01-5T F3LE11-0T	Ethernet	<a href="#">Setting</a>	<a href="#">Your owner cable</a>
	F3SP66-4S F3SP67-6S	Ethernet I/F on CPU Unit			

### ◎ Serial Communication Setting

#### HMI Setting

**RS232** default communication: 9600, 8, 1, even; station: 0 (station number disable)

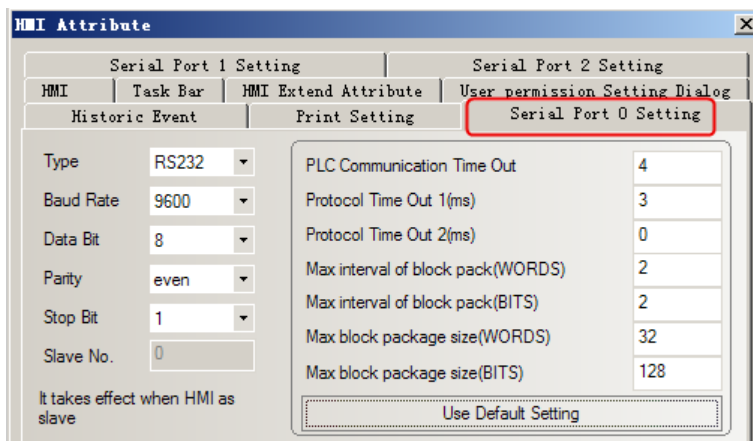

**RS422** default communication: 19200, 8, 1, none; station: 1

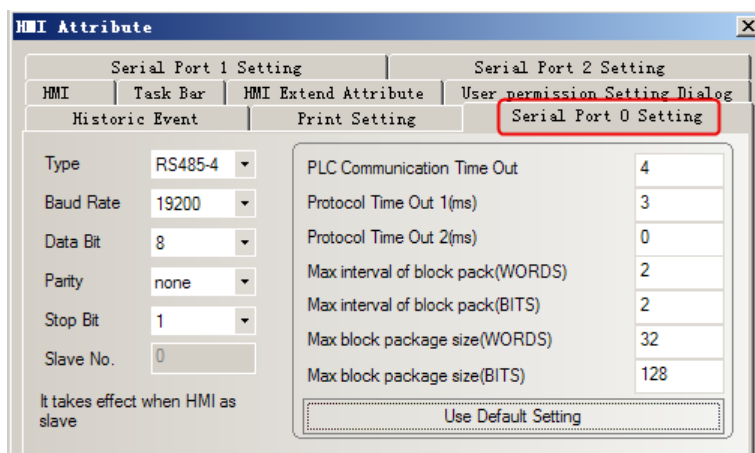

**RS485** default communication: 19200, 8, 1, none; station: 1

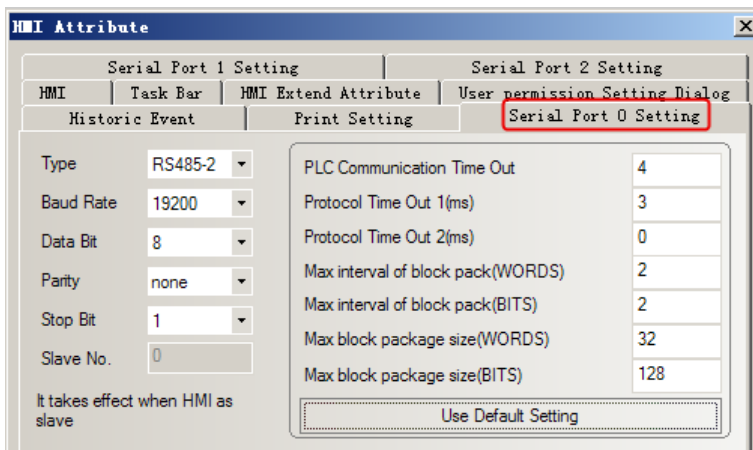

## PLC Setting

### RS422 communication configuration

Set the 485 communication module on the right as below.

1. Transmission Speed Setting Switch: SW1=7
2. Data Code Setting Switch: SW2

Bit	Settings	Setup Description
1	ON	Data Length

2	OFF	Parity Bit
3	OFF	--
4	OFF	Stop Bit
5	OFF	Exist Sum Check
6	ON	Exist Terminator
7	OFF	Protect
8	OFF	Always OFF

3. Station No. setting 1

4. Set the termination resistance switch of only the module which terminates the connection to 4- WIRE

**RS485 communication configuration**

Set the 485 communication module on the right as below.

1. Transmission Speed Setting Switch: SW1=7

2. Data Code Setting Switch: SW2

Bit	Settings	Setup Description
1	ON	Data Length
2	OFF	Parity Bit
3	OFF	--
4	OFF	Stop Bit
5	OFF	Exist Sum Check
6	ON	Exist Terminator
7	OFF	Protect
8	OFF	Always OFF

3. Station No. setting 1

4. Set the termination resistance switch of only the module which terminates the connection to 2- WIRE.

**◎ Network Communication Setting**

**HMI Setting**

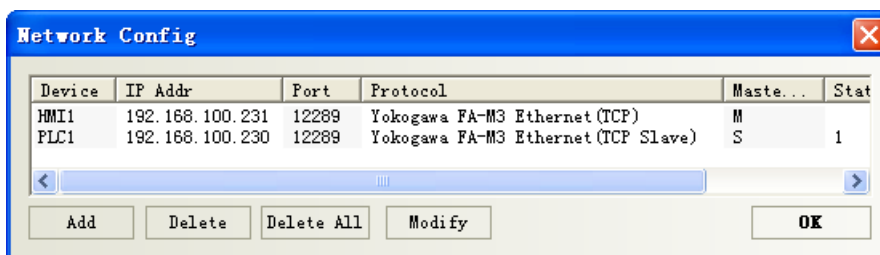
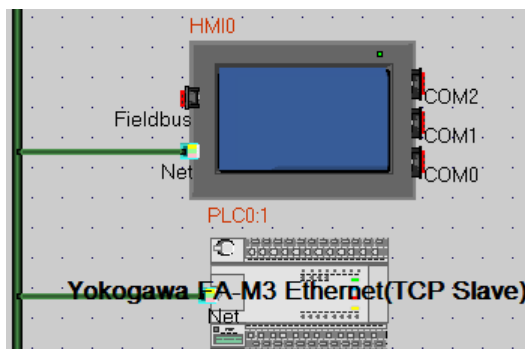

**PLC setting**

Use the swiches on the right side of Ethernet module for setting the External Device.

1. Set all condition setup switch off.
2. Set IP Address: 192.168.100.230.

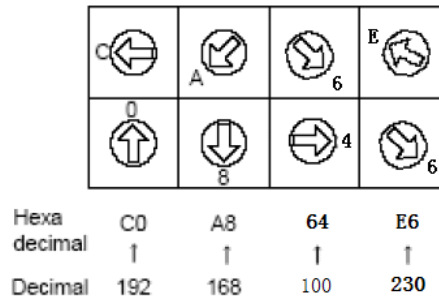

### ⊙ Supported Device

Device	Bit Address	Word Address	Format	Notes
Link Relay	L 1~256	-----	DDD	
Special Relay	M 1~256	-----	DDD	
Internal Relay	I 1~256	-----	DDDD	
Output Relay	Y (233~264)&(333~364)	-----	DDD	
Input Relay	X (201~232)&( 301~332)	-----	DDD	Read only
Special Register	-----	Z_word 1~256	DDDD	
Link Register	-----	W_word 1~256	DDD	
Index Register	-----	V_word 1~64	DD	
File Register	-----	B_word 1~256	DD	
Data Register	-----	D_word 1~256	DDD	

### ⊙ Cable Diagram

#### RS232 communication cable

Yokogawa programming cable

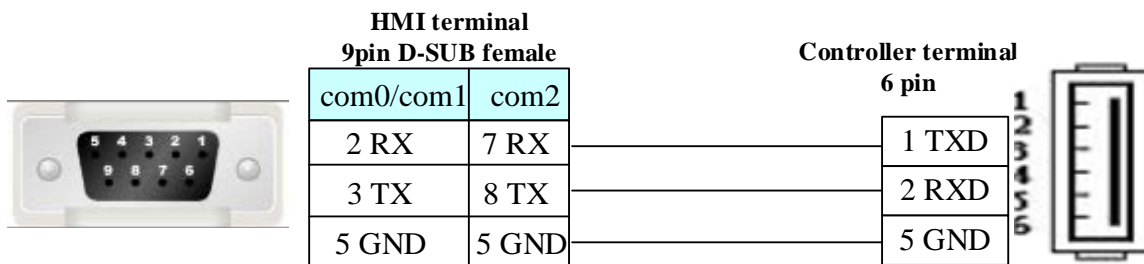

#### RS422 communication cable



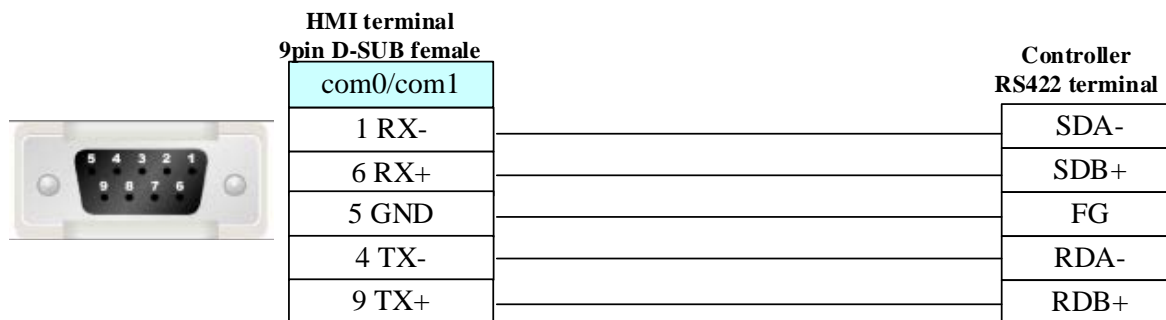

### RS485 communication cable

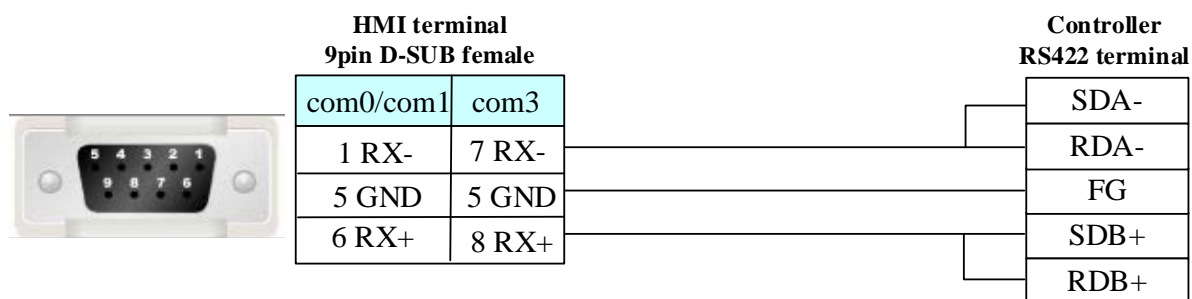

### Ethernet communication protocol cable

Cross-connection or crossover network cable can be used as communication cable via the hub

Refer to [3.3 Download by Network Ethernet](#) for method of making connection cable.

## 4.89 YuDian AI

### Serial Communication

Series	CPU	Link Module	Driver
AI	AI-518 AI-701	RS485 on the CPU unit	YuDian AI Single_Loop
	AI-7048	RS485 on the CPU unit	YuDian AI 4_Loop

### System configuration

Series	CPU	Link Module	COMM Type	Parameter	Cable
AI	AI-518 AI-701	RS485 on the CPU unit	RS485	<a href="#">Setting</a>	<a href="#">Your owner cable</a>
	AI-7048	RS485 on the CPU unit	RS485	<a href="#">Setting</a>	<a href="#">Your owner cable</a>

### Communication Setting

#### HMI Setting

Default communication: 9600, 8, none, 1; station: 1

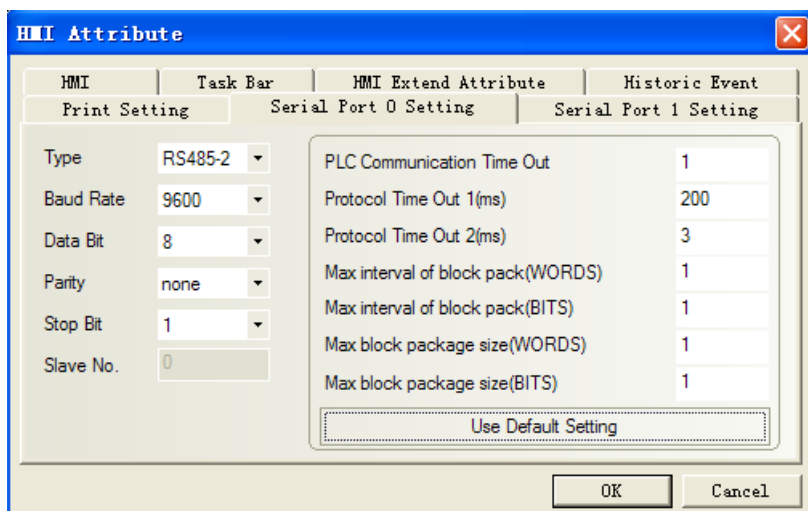

## ◎ Supported Device

### YuDian AI Single\_Loop

Device	Bit Address	Word Address (参数代号)	Format	Notes
HiAL	0	-----	D	Read only
LoAL	0	-----	D	Read only
dHAL	0	-----	D	Read only
dLAL	0	-----	D	Read only
orAL	0	-----	D	Read only
AL1	0	-----	D	Read only
AL2	0	-----	D	Read only
PV	-----	0	D	Read only
MV	-----	0	D	
SV	-----	0	D	
ALARM	-----	0	D	Read only
Reference	-----	86	DD	Address correspond to AI parameters code

#### NOTE:

- 1、 When setting the parameter of ADDR, it match the PLC Station Number .
- 2、 If connecting many devices, you should set different ADDR values.

### YuDian AI 4\_Loop

#### AI-7048

Device	Bit Address	Word Address (参数代号)	Format	Notes
HiAL	0.0-3.0	-----	D.D	Read only
LoAL	0.0-3.0	-----	D.D	Read only
dHAL	0.0-3.0	-----	D.D	Read only
dLAL	0.0-3.0	-----	D.D	Read only
orAL	0.0-3.0	-----	D.D	Read only
AL1	0.0-3.0	-----	D.D	Read only
AL2	0.0-3.0	-----	D.D	Read only

PV	-----	0.0-3.0	D.D	Read only
MV	-----	0.0-3.0	D.D	
SV	-----	0.0-3.0	D.D	
ALARM	-----	0.0-3.0	D.D	Read only
Reference	-----	0.0-3.086	D.DDD	Address correspond to AI parameters code

**NOTE:**

- 1、 When setting the parameter of ADDR, it match the PLC Station Number.
- 2、 If connecting many devices, you should set different ADDR values.
- 3、 AI-7048 has 4 loops, so it occupies 4 address, For instance, Addr=5,address 5~8 were used by this controller, other controller can't use address 5~8.

**EXAMPLE**

Take HIAL for example, look up table and then know that HIAL parameters code is 1, so HIAL for 4 channels correspond to address in HMI should be Reference0.01, Reference1.01, Reference2.01, Reference3.01. If station number is 2, Reference0.01 is HIAL address of channel 2(station No. 2 + main address 0), Reference1.01 is HIAL address of channel 2(station No. 2 + main address 1), and so on.

Thereinto the setting of station number is very important, it denotes start address of the controller (viz. instrument address in instrument parameter), and main address just denotes 4 channels. When main address is 0, it denotes channel (station number+0)

**TABLE**

Table 1

Parameter Code	Adjustor		Inspection instrument	
	AI-518/708/808/518P/708P/808P	AI-519/719/719P	AI-501/701	AI-702M/704M/706M
0	SV /SteP	SV /SteP	N/A	N/A
1	HIAL	HIAL	HIAL	HIAL
2	LoAL	LoAL	LoAL	LoAL
3	dHAL	HdAL	HdAL	N/A
4	dLAL	LdAL	LdAL	N/A
5	dF	CHYS	AHYS	dF
6	Ctrl	Ctrl	N/A	N/A
7	M5	P	N/A	N/A
8	P	I	N/A	N/A
9	t	d	N/A	N/A
10	Ctl	Ctl	N/A	N/A
11	Sn	InP	InP	Sn
12	dIP	dPt	dPt	dIP
13	dIL	SCL	SCL	dIL
14	dIH	SCH	SCH	dIH
15	ALP	AOP	AOP	ALP

16	Sc	Scb	Scb	Sc
17	OP1	OPt	OPt	OPn
18	oPL	OPL	N/A	oPL
19	oPH	OPH	N/A	oPH
20	CF	AF	N/A	Cn
21	Feature codes/Program control words(Run:0 Pause:4 Stop:12)	Feature codes/Program control words(Run:0 Pause:4 Stop:12)	Feature codes(the same to SV, and it can be modified)	Feature codes
22	Add. (R/W)	Add. (R/W)	Add. (R/W)	Add. (R/W)
23	dL	FILt	FILt	dL
24	run	A-M	N/A	nonc
25	Loc	Loc	Loc	Loc
26	C01(set the MV when writing AI-808)	C01(set the MV when writing AI-519/719)		
27	t01	t01		
28	C02	C02		
29	t02	t02		
30	C03	C03		
31	t03	t03		
32	C04	C04		
33	t04	t04		
34	C05	C05		
35	t05	t05		
36	C06	C06		
37	t06	t06		
38	C07	C07		
39	t07	t07		
40	C08	C08		
41	t08	t08		
42	C09	C09		
43-85	t09-C30	t09-C30		
86	Run time of current program	Run time of current program		

Table 2

Parameter Code		Flow totalizer	AI-301M	4 loop PID adjustor
DEC	HEX	(AI-708H/Y/808H)	Frequency measurement/switching value	AI-7048
0	00H	SV	SV	SP
1	01H	FHIA	HIAL	HIAL

4 Communication settings and guide of HMI connecting with controller

2	02H	FloA	LoAL	LoAL
3	03H	SPE	dHAL	
4	04H	Act	dLAL	
5	05H	Sn	dF	AHYS
6	06H	FSc	Ctrl	At
7	07H	PdIH	M5	P
8	08H	CSc	P	l
9	09H	CdIH	t	d
10	0AH	Cut	Ctl	
11	0BH	FdIH	Frd	InP
12	0CH	FdIP	dIP	dPt
13	0DH	PA	dIL	SCL
14	0EH	Po	dIH	SCH
15	0FH	Co	ALP	AOP
16	10H	Frd	switch state	Scb
17	11H	CF	oP1	
18	12H	bC	OPL	
19	13H	loL	OPH	OPH
20	14H	FoH	CF	AF
21	15H	Feature codes	Feature codes	Feature codes
22	16H	Add. (R/W)	Add. (R/W)	Add. (R/W)
23	17H	loH	dL	FILt
24	18H	FdL	run	Nonc
25	19H	Loc	Loc	Loc
26	1AH	N/A	MV	Cn
27	1BH	FdF		
28	1CH	CHIA		
29	1DH	CLoA		
30	1EH	PHIA		
31	1FH	PLoA		
32	20H	ALP		
33	21H	FSb		
34	22H	CdIP		
35	23H	PdIP		
36	24H	PSc		
37	25H	CLn		
38	26H	FLJH		
39	27H	FLJL		
40	28H	EJH		
41	29H	EJL		
42	2AH	Mass accumulation value of zero position		

43-85	2BH-55H		
86	56H		

### ◎ Cable Diagram

#### RS485 communication cable

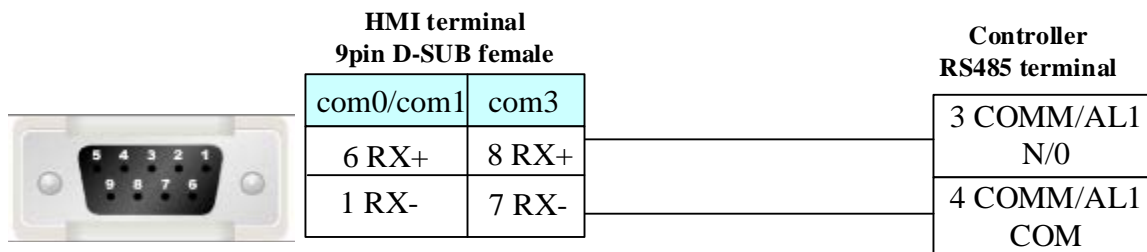

#### RS232 communication cable

Need to use *RS-232 to RS-422/485* converter

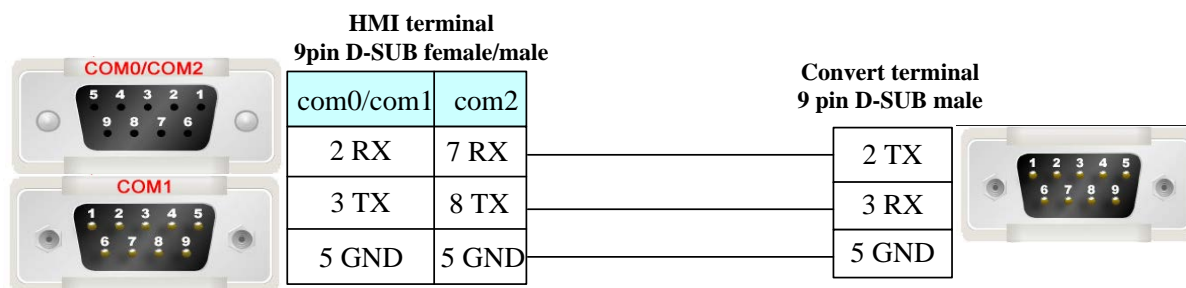

## 4.90 ZiGuang Ethernet

### ◎ Network Communication

Series	CPU	Link Module	Driver
ZiGuang Ethernet	UNIS-600C	Ethernet	ZiGuang Ethernet Slave

### ◎ Network System configuration

Series	CPU	Link Module	COMM Type	Parameter	Cable
ZiGuang Ethernet	UNIS-600C	Ethernet	Ethernet	<a href="#">Setting</a>	<a href="#">Your owner cable</a>

### ◎ Ethernet Communication Setting

#### HMI Setting

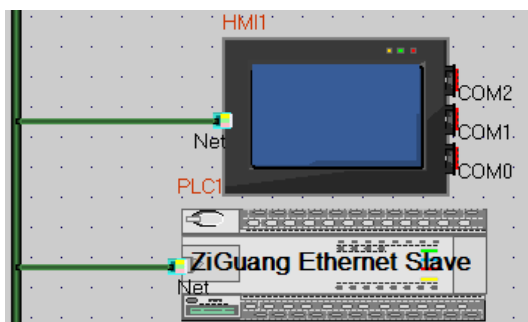

Device	IP Addr	Port	Protocol	Master/...	State...
HMI1	192.168.0.1	50002	ZiGuang Ethernet	M	
PLC1	192.168.0.156	50002	ZiGuang Ethernet Slave	S	100

Buttons: Add, Delete, Delete All, Modify, OK

### PLC Setting

1. Settings in the software as follows:

(1) System basic configuration: Set the controller number, IP address, and the PC IP address.

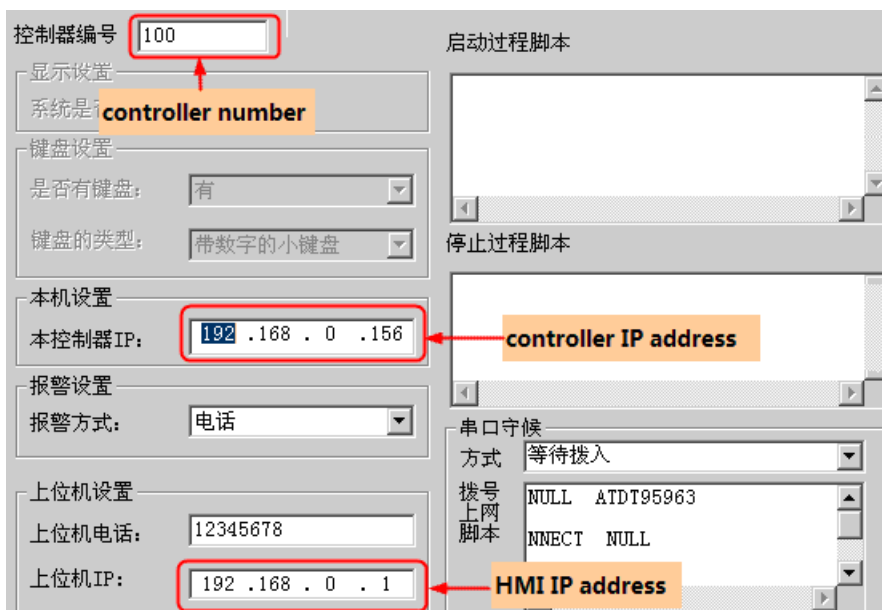

(2) Configuration of data tag: set the parameters according to the actual I/O card. The PLC register address should be the same as the ID number of the data tag.

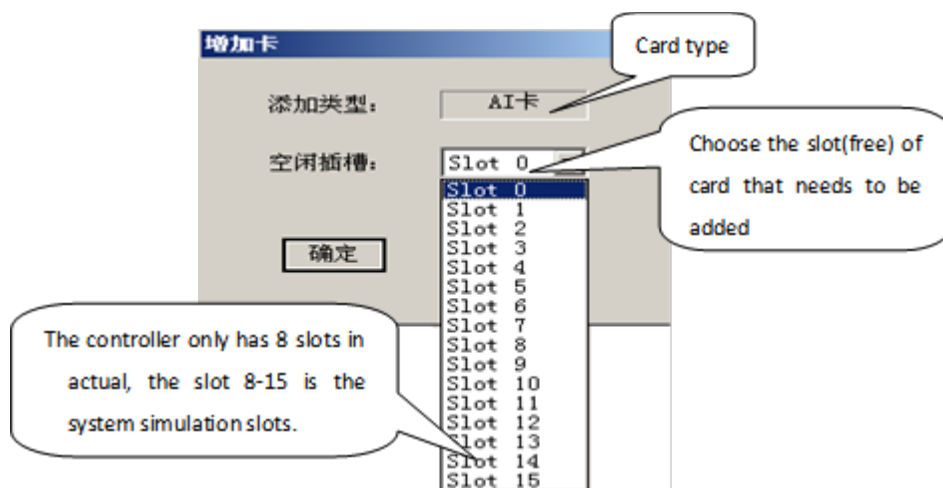
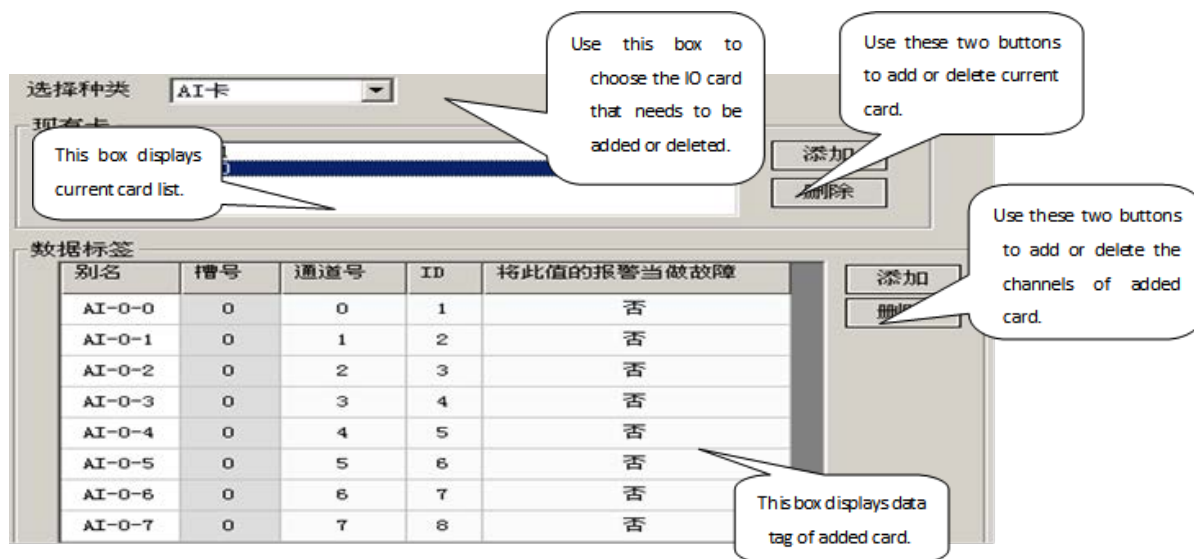

(3) Update and get configuration: After finish the system basic configuration and data tag configuration, choose the **Update Configuration** in the **Tool** menu or click the icon to update the configurations in the controller. Choose the **Get Configuration** in the **Tool** menu or click the icon to get the configuration in the controller.

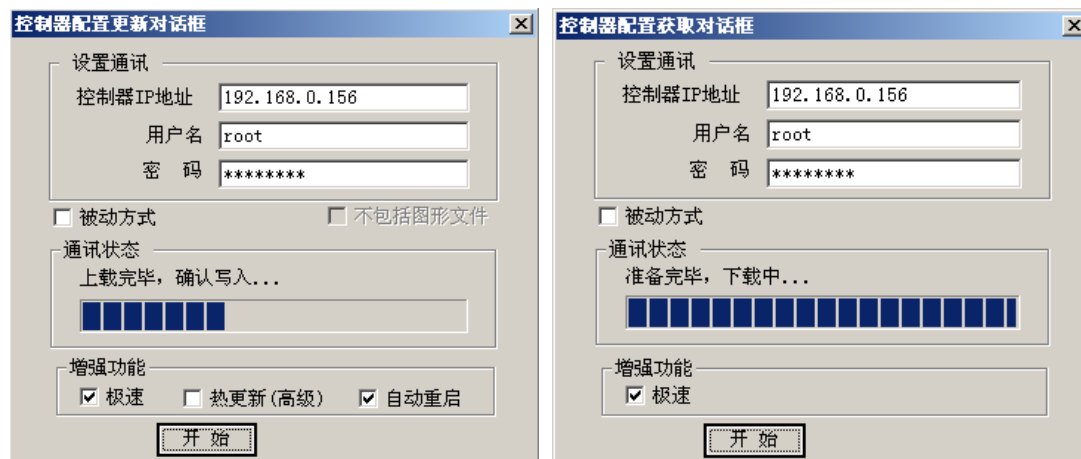



(4) Click  icon after updating controller configuration, then it will pop up WinEmu window, real-time control of script debugging window and none-real time control of script debugging window.

WinEmu window monitors the internal data of controller, real-time control of script debugging window and none-real time control of script debugging window provide environment for customer secondary development.

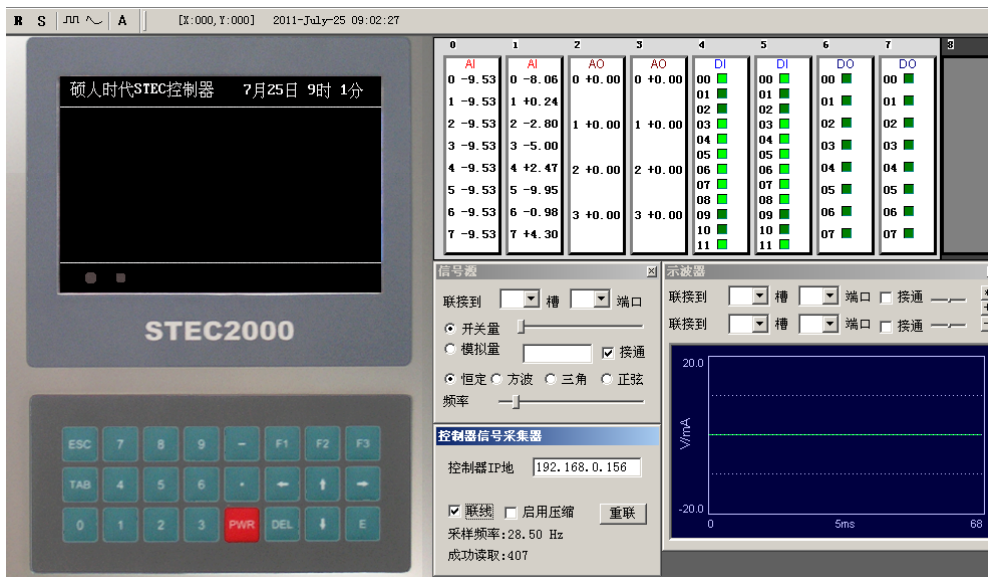

### ◎Supported Device

Device	Bit Address	Word Address	Format	Notes
Bool_Read	Bool_Read 0-65535	-----	DDDDD	Read only
Bool_Write	Bool_Write 0-65535	-----	DDDDD	Write only
Float_Read	-----	Float_Read 0-65535	DDDDD	Read only
Int_Read	-----	Int_Read 0-65535	DDDDD	Read only
Float_Write	-----	Float_Write 0-65535	DDDDD	Write only
Int_Write	-----	Int_Write 0-65535	DDDDD	Write only
	-----	Time 0-2	D	

**NOTE:** The name and address of registers in HMI must be same as register in Ziguang controller when defining in HMI.

### ◎Cable Diagram

#### Ethernet communication protocol cable

Cross-connection or crossover network cable can be used as communication cable via the hub

Refer to [3.3 Download by Network Ethernet](#) for method of making connection cable.

## 4.91 ZHIMEI CB920X

### ◎Serial Communication

Series	CPU	Link Module	Driver
--------	-----	-------------	--------

CB920X	CB920X-10	RS485 on the CPU unit	<a href="#">ZHIMEI CB920X</a>
--------	-----------	-----------------------	-------------------------------

◎ **System configuration**

Series	CPU	Link Module	Connect Type	Parameter	Cable
CB920X	CB920X-10	RS485 on the CPU unit	RS485	<a href="#">Setting</a>	<a href="#">Your owner cable</a>

◎ **Communication Setting**

**HMI Setting**

Default communication: 9600, 7, even, 1; station: 1

**RS485**

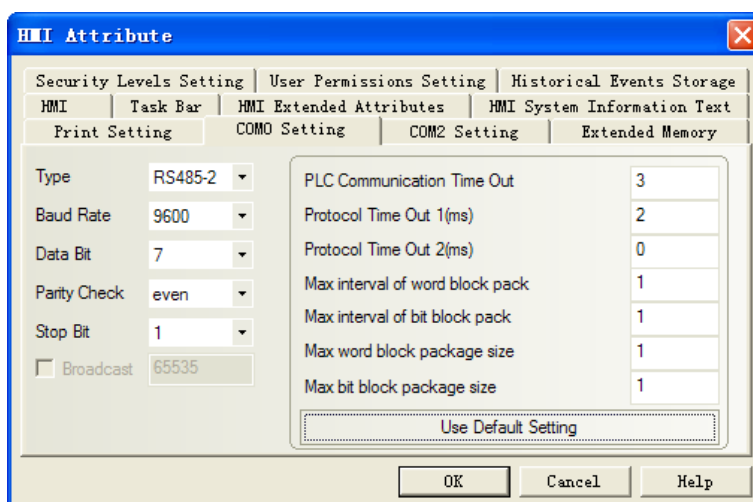

**PLC Setting**

Please refer to the manual of controller.

◎ **Supported Device**

Device	Bit Address	Word Address	Format	Notes
	-----	FUNC1-FUNC42	DD	
	-----	READ0	D	

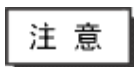

1. The controller station can set 1~99, don't support station 0.
2. The FUNC parameter cannot be arbitrarily set, please refer to the controller manual. If the settings in the HMI value is not in the allowed range, it will retain a valid value
- 3.FUNC registers, when in use, select "Hex data type".
- 4.Weighing register READ is read-only register, and only 0 address is effective. When in use, select the text display component, 4 words.

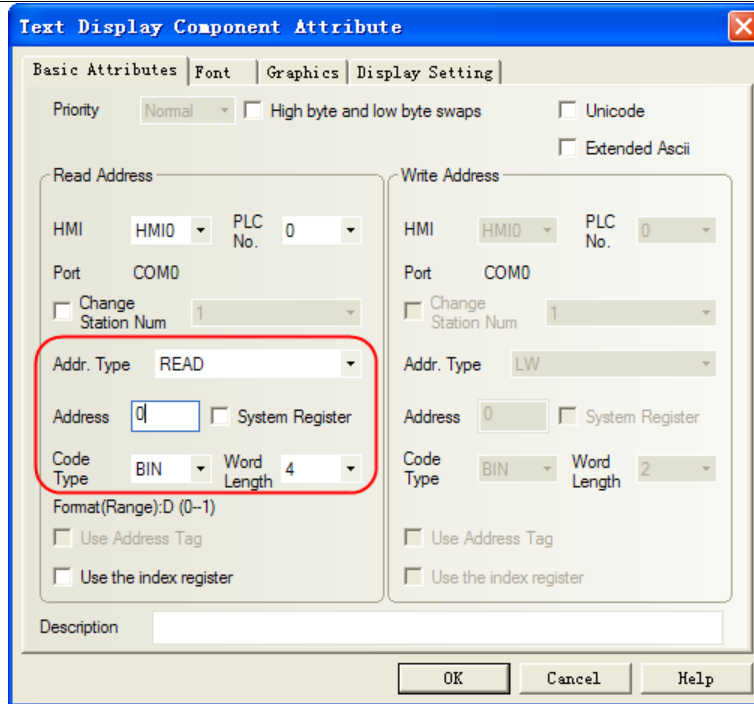

5. Suggest place the FUNC and READ registers in the different configuration window, because the FUNC is the functional setting register, when in a functional setting condition, the RS485 interface will always send instructions, and you cannot read the weight register.

### © Cable Diagram

#### RS485

